

Unanticipated Side Effects of Successful Quality Programs: Technical Documentation

Nelson P. Repenning
John D. Sterman

Department of Operations Management and System Dynamics
Sloan School of Management, E53-336
Massachusetts Institute of Technology
Cambridge, MA. USA 02142
Phone: 617-253-0250 Fax: 617-253-6466
E-Mail: nelsonr@mit.edu

August 1994

Table of Contents

0. Overview	1
1. Product Development	4
1.0 Overview	4
1.1 Research and Development Capacity	4
1.1.1 Expected Research and Development Budget	4
1.1.2 Research and Development Staffing	5
1.1.3 Maximum Product Development Capacity	7
1.2 Product Development	10
1.2.1 The Product Development Chain	10
1.2.2 Partitioning Product Development Time	14
1.2.3 Fraction of Budget to Breakthrough Products	19
2. The Market for Analog's Products	22
2.0 Overview	22
2.1 The Size of the Market	22
2.1.1 Breakthrough Products and the Potential Market	22
2.1.2 Growth in the Potential Market	24
2.1.3 Average Age of the Product Portfolio	26
2.1.4 Line Extension Products	27
2.2 Market Share	30
2.2.1 Attractiveness	30
2.2.2 Customer Perceptions	38
2.3 Unit Sales	41
3. Manufacturing	
3.0 Overview	43
3.1 Backlog and Quoted Lead-times	43
3.2 Forecasting Sales, Cycle Time, and Yield	46
3.3 Materials Acquisition and Inventory	49
3.4 Wafer Starts, WIP and Finished Goods Inventory	51
3.5 Production Capacity	55
3.5.1 The Product Function	55
3.5.2 The Desired Capacity Level	59
3.6 Factor Acquisition	61
3.6.1 Capital	61
3.6.2 Labor	64

4. Improvement	
4.0 Overview	66
4.1 Manufacturing	66
4.1.1 Cycle Time	67
4.1.2 Yield	69
4.1.3 Defects	71
4.1.4 On Time Delivery	72
4.2 Product Development Time	74
4.2.1 Breakthrough Products	74
4.2.2 Line Extension Products	75
4.3 Measuring Improvement Rates	76
4.3.1 Productivity Improvement	76
4.3.2 Product Development Time	78
5. Diffusion of Skills and Commitment	
5.0 Overview	80
5.1 The Dynamics of Commitment	80
5.1.1 Commitment in Manufacturing	80
5.1.2 Commitment in Product Development	87
5.2 Job Security	92
5.3 Resource Allocation and Adequacy	94
5.3.1 Manufacturing's Resource Adequacy	95
5.3.2 Product Development's Resource Adequacy	96
5.4 Support Resource Allocation	97
6. Management Accounting	
6.0 Overview	100
6.1 Cost of Material	100
6.1.1 Valuing Materials Inventory	100
6.1.2 Material Cost of WIP and Finished Goods Inventory	103
6.2 Production Expenses	106
6.2.1 Product Attributable Overhead	106
6.2.2 Non-Product Attributable Overhead	107
6.2.3 Labor Expense	110
6.4 Budgeting	111

6.5 Variance Calculations	114
6.5.1 Capital Variance	114
6.5.2 Labor Variances	115
6.5.3 Overhead Variances	116
6.6 Cost Tracking Co-Flows	117
6.6.1 Capital Expense	117
6.6.2 Labor Expenses	118
6.6.3 Overhead Expenses	120
6.7 Cost of Goods Sold	121
6.8 Total Inventory Value	122
7. Pricing	
7.0 Overview	123
7.1 Target Profit Margin	123
7.2 Target Price	124
7.3 Actual Price	125
7.4 Tracking Prices in the Backlog	128
8. Financial Accounting	
8.0 Overview	129
8.1 Income Statement	130
8.2 Balance Sheet	132
8.2.1 Assets	132
8.2.1.1 Cash	132
8.2.1.2 Accounts Receivable	135
8.2.1.3 Value of Inventory	136
8.2.1.4 Capital Stock	137
8.2.1.5 Total Assets	138
8.2.2 Liabilities	138
8.2.2.1 Accounts Payable	138
8.2.2.2 Short Term Debt	141
8.2.2.3 Long Term Debt	144
8.2.3 Equity	147
8.2.4 Total Liabilities and Equity	148
8.3 Cash Flow Statement	149
9. R and D Budgeting	151
10. Stock Market	156

11. Financial Stress	164
12. Competitor	
12.0 Overview	170
12.1 Defects	171
12.2 Lead Time	173
12.3 On-Time Delivery	174
12.4 Cycle Time	176
12.5 Yield	177
12.6 Pricing	178
12.6.1 Reduction from Improvement	178
12.6.2 Competitor Price Index	179
12.6.3 Price Setting	181
13. Accumulators and Actual Data	183
14. Partial Model Tests	196
15. Instructions for Replicating Policy Simulations	204
16. References	207

0. Overview

The purpose of this report is to provide a detailed description and supporting documentation for a system dynamics model used to analyze the effects of a successful quality and productivity improvement program. The model is based on the experience of one company, Analog Devices Inc., located in Norwood Massachusetts. Analog's experiences with Total Quality Management were first discussed by its CEO Ray Stata [Stata 1989] and later documented in more detail by Robert Kaplan in a case study and an accompanying teaching note [Kaplan 1990a 1990b]. This document should be used in conjunction with Kofman, Reppenning and Sterman [1994]¹. The paper provides background information and presents model results. This document provides a complete description of the model and instructions for replicating the results in the paper.

The model contains twelve major sectors: product development, the market, production, quality and productivity improvement, commitment to improvement, managerial accounting, pricing, financial accounting, research and development spending, the stock market, financial stress, and an aggregate competitor. The relationship between the sectors is shown in the sector diagram below. Each sector is discussed below in equation level detail. In general the model's formulations draw upon established system dynamics models of the firm [Lyneis 1981, Forrester 1961] and the behavioral approach outlined by Morecroft, Cyert and March, and Simon [Cyert and March 1992, Morecroft 1985, Simon 1976].

The source code for the model is written using the iThink™ modeling software, version 2.2.2, available from High Performance Systems in Hanover New Hampshire. The stock and flow diagrams used throughout the report were copied directly from the iThink™ model. A working copy of the model is available from the authors. The cross referenced equation listing was produced using XREF, a freeware program written by Tom Fiddaman.

All historical time series of financial measures used in the model were taken directly from Analog's annual reports [Analog Devices 1985, 1986, 1987, 1988, 1989, 1990]. Annual unit sales data and historical performance measures for yield, cycle time, outgoing defects, and on-time delivery were provided to us by Analog.

The equations are reproduced exactly as used in the simulation model except that each equation has been assigned a number. Additional information is also provided with each equation to allow the reader to rapidly follow the logic of the model. An example is provided below.

¹. This documentation corresponds to August 1994 version of Kofman, Reppenning, and Sterman 1994.

433: Net_Income = Taxable_Income-Tax_Payments

DEFN: Net Income

USES: Tax_Payments(439) Taxable_Income(437)

AFFX: Net_Cash_by_Operations(500) Retained_Period_Earnings(520) Earnings_per_Share(530)

Return_on_Capital(543) Return_on_Equity(544)

UNITS: dollars/month

The equation that determines net income is number 433. Immediately following the line number and the colon is the actual equation exactly as it appears in the simulation model: Net income is equal to taxable income minus the required tax payments. The definition line, labeled DEFN, gives the full name of the variable in question. The line labeled USES lists the inputs to net income and their respective equation numbers. In this case, the two determinants of net income are taxable income, defined in equation #437, and tax payments, defined in equation #439. The next line, labeled AFFX, lists all the variables in the model, and their respective equation numbers, that are affected by net income. In this case, net cash flow from operations (#500), retained period earnings (#520), earnings per share (#530), return on capital (#543), and return on equity (#544) are all affected by net income. This format should allow the reader to quickly follow the logic of the model. Finally, the units of measure are also presented for each variable. In this example, net income is measured in dollars per month.

Analog Devices Model- Model Sector Diagram

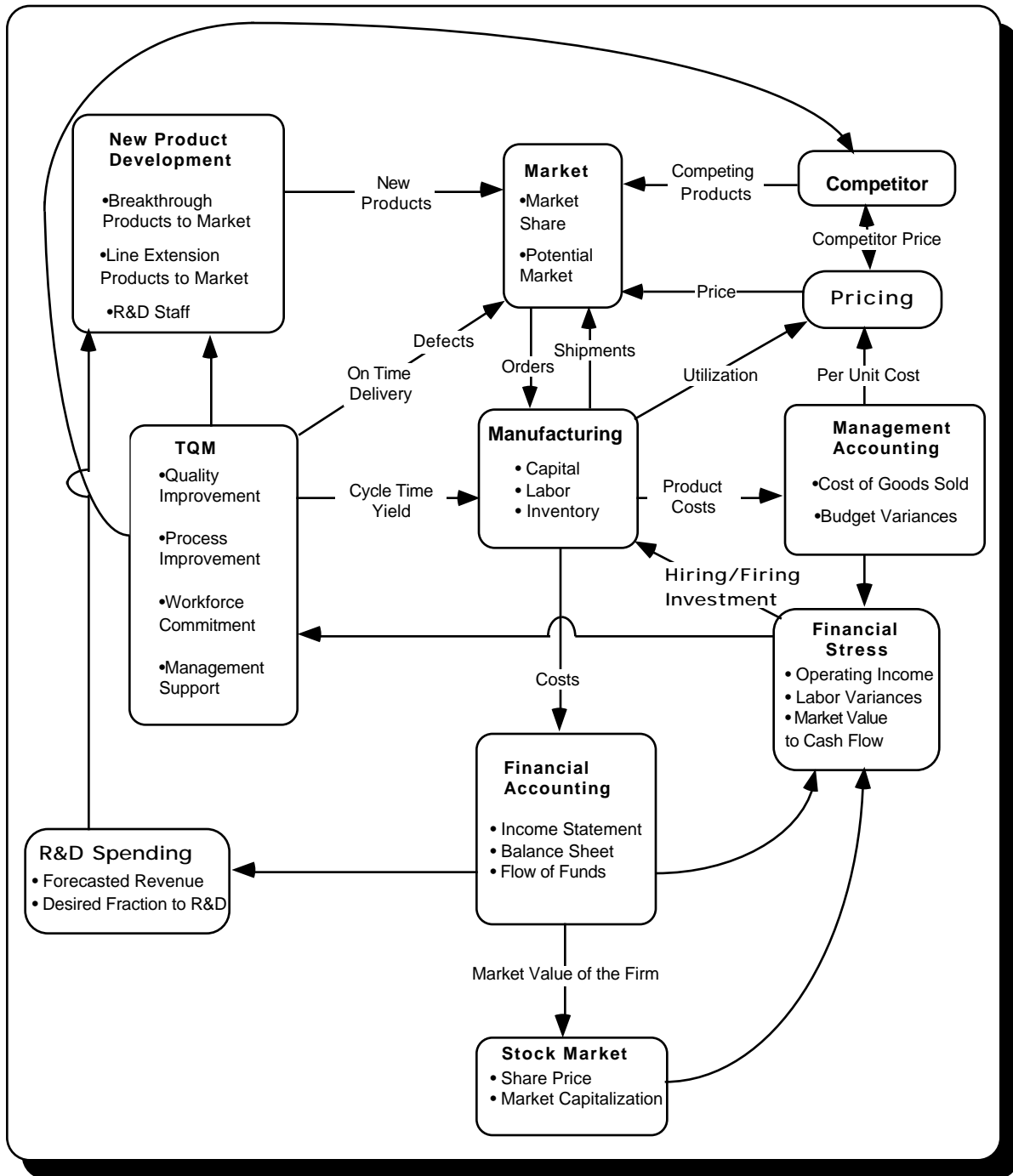

1. Product Development

1.0 Overview

The first sector in the model represents the process of developing products and bringing them to market. It takes the research and development budget, determined in sector #9, as its primary input. Its primary output is new products which are placed on the market in the market sector (#2). The expected R and D budget is an exponential average of actual research and development spending. Based upon this expectation, a simple heuristic is used to determine the number of development engineers that can be supported given the expected budget. Each engineer is assumed to be involved in a fixed number of development projects. The available development capacity is allocated between two types of products, breakthroughs and line extensions. A third order material delay is used to model the development process. The formulations in this sector draw heavily on data taken from interviews with Analog staff [Kress 1992, Schneiderman 1992].

1.1 Research and Development Capacity

This sub-sector determines the total available research and development capacity. The managers of the research and development function determine total development capacity based upon their expectation for future research and development spending. Actual research and development spending is assumed to be determined by a higher tier of management and, as a result, is taken as an exogenous input by research and development managers. In the model actual R and D spending is determined in sector #9.

1.1.1 Expected Research and Development Budget

Expectations concerning the research and development budget are assumed to be formed adaptively as an exponentially weighted average of historical R and D spending. The assumption of adaptive expectations will be made numerous times in the model. This form of expectations has been shown to replicate actual human decision making and to frequently outperform other forecasting methods [Sterman 1988 1987, Armstrong 1985, Forrester 1961].

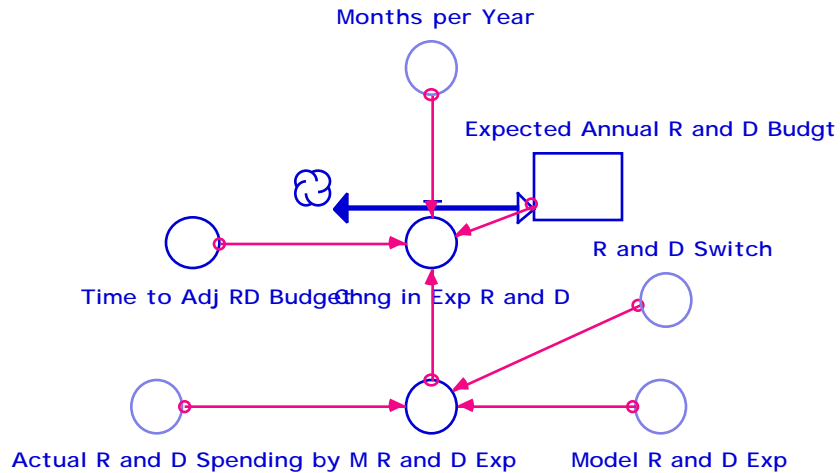

1: $\text{Expected_Annual_R_and_D_Budgt} = \text{Expected_Annual_R_and_D_Budgt} * (t-dt) + (\text{Chng_in_Exp_R_and_D}) * dt$
 INIT: $\text{Actual_R_and_D_Spending_by_M} * \text{Months_per_Year}$

DEFN: Expected Annual Research and Development Budget
 USES: $\text{Actual_R_and_D_Spending_by_M}(645)$ $\text{Chng_in_Exp_R_and_D}(2)$ $\text{Months_per_Year}(657)$
 AFFX: $\text{Chng_in_Exp_R_and_D}(2)$ $\text{Desired_Staff}(8)$
 UNITS: dollars/year

2: $\text{Chng_in_Exp_R_and_D} = (\text{R_and_D_Exp} * \text{Months_per_Year} - \text{Expected_Annual_R_and_D_Budgt}) / \text{Time_to_Adj_RD_Budget}$

DEFN: Change in the Expected Research and Development Expenditure
 USES: $\text{Expected_Annual_R_and_D_Budgt}(1)$ $\text{Months_per_Year}(657)$ $\text{R_and_D_Exp}(13)$
 $\text{Time_to_Adj_RD_Budget}(14)$
 AFFX: $\text{Expected_Annual_R_and_D_Budgt}(1)$
 UNITS: dollars/year/month

13: $\text{R_and_D_Exp} = \text{Model_R_and_D_Exp} * (1 - \text{R_and_D_Switch}) + \text{Actual_R_and_D_Spending_by_M} * \text{R_and_D_Switch}$

DEFN: Expenditure on Research and Development
 USES: $\text{Actual_R_and_D_Spending_by_M}(645)$ $\text{Model_R_and_D_Exp}(512)$ $\text{R_and_D_Switch}(665)$
 AFFX: $\text{Chng_in_Exp_R_and_D}(2)$ $\text{Operating_Exp}(434)$
 UNITS: dollars/month

14: $\text{Time_to_Adj_RD_Budget} = 3$

DEFN: Average Time Required to Adjust the Expected Research and Development Budget
 AFFX: $\text{Chng_in_Exp_R_and_D}(2)$
 UNITS: months

Initially, the expected research and development budget is set equal to Analog's actual research and development spending for the beginning of 1985. For the purpose of conducting partial model tests, the input to this process can be switched between the endogenously generated research and development spending and the actual historical time series. The time constant for this process, assumed to be three months, is based upon the standard quarterly budgeting cycle.

1.1.2 Research and Development Staffing

Based upon their expectation for future research and development spending, the R&D managers are assumed to use a simple heuristic to determine the number of product development engineers that can be supported:

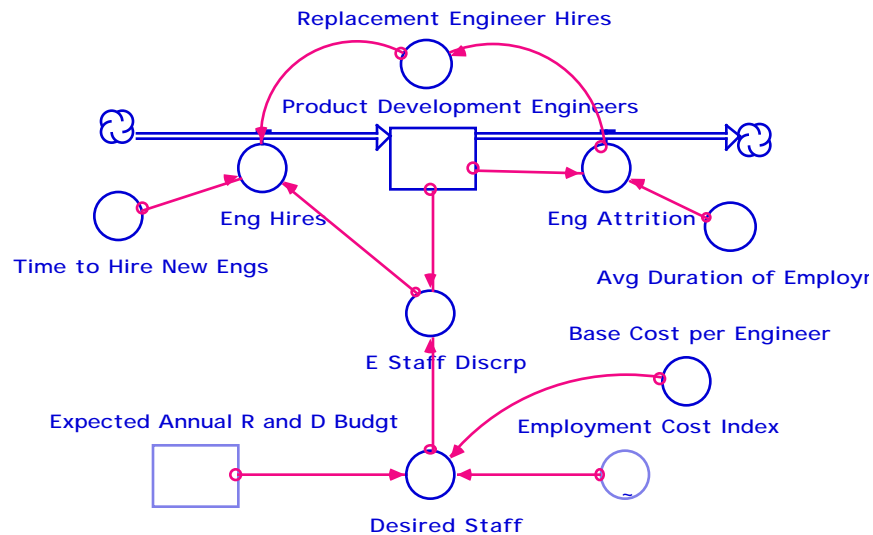

The desired staffing level is determined by dividing the expected annual research and development budget by the annual cost per engineer. The cost per engineer, including equipment and support staff, is set to be one million dollars adjusted for inflation by the employment cost index, based upon interview data [Kress 1992]. The formulation approximates the process actually used by Analog management and was identified through interviews with Analog's product development managers [Kress 1992].

8: $\text{Desired_Staff} = \frac{\text{Expected_Annual_R_and_D_Budgt}}{(\text{Base_Cost_per_Engineer} * \text{Employment_Cost_Index})}$

DEFN: Desired Product Development Staff
 USES: Base_Cost_per_Engineer(7) Employment_Cost_Index(690)
 Expected_Annual_R_and_D_Budgt(1)
 AFFX: Product_Development_Engineers(3) E_Staff_Discrpn(9)
 UNITS: engineers

7: $\text{Base_Cost_per_Engineer} = 1e6$

DEFN: Base Annual Cost per Engineer including Support and Equipment
 AFFX: Desired_Staff(8)
 UNITS: dollars/engineer/year

Given the desired staffing level, the actual number of development engineers is determined using the standard human resource formulation [Mass 1975, Forester 1961]. The stock of development

engineers is increased by hiring and decreased by attrition. There are assumed to be no significant layoffs for this type of employee.

3: $\text{Product_Development_Engineers} = \text{Product_Development_Engineers} * (t-dt) + (\text{Eng_Hires} - \text{Eng_Attrition}) * dt$
 INIT: Desired_Staff

DEFN: Product Development Engineers
 USES: Desired_Staff(8) Eng_Attrition(5) Eng_Hires(4)
 AFFX: Eng_Attrition(5) E_Staff_Discrp(9) Max_Dvlp_Capacity(10) PDT_TQ_Support_Required(307)
 UNITS: engineers

Hiring is constrained to be positive and is otherwise equal to the attrition rate plus a fractional correction for the gap between the desired and actual stocks of engineers. The correction is equal to the current discrepancy divided by the average time required to hire an engineer. The average hiring time is set to six months based upon data taken from interviews [Kress 1992].

4: $\text{Eng_Hires} = \text{Replacement_Engineer_Hires} + (\text{E_Staff_Discrp} / \text{Time_to_Hire_New_Engs})$

DEFN: Product Development Engineers Hired
 USES: E_Staff_Discrp(9) Replacement_Engineer_Hires(12) Time_to_Hire_New_Engs(15)
 AFFX: Product_Development_Engineers(3)
 UNITS: engineers/month

12: $\text{Replacement_Engineer_Hires} = \text{Eng_Attrition}$

DEFN: Rate of Engineer Hires Required to Replace those that have Left
 USES: Eng_Attrition(5)
 AFFX: Eng_Hires(4)
 UNITS: engineers/month

9: $\text{E_Staff_Discrp} = \text{Desired_Staff} - \text{Product_Development_Engineers}$

DEFN: Discrepancy between the Desired and Actual Number of the Product Development Engineers
 USES: Desired_Staff(8) Product_Development_Engineers(3)
 AFFX: Eng_Hires(4)
 UNITS: engineers

15: $\text{Time_to_Hire_New_Engs} = 6$

DEFN: Time Required to Hire New Product Development Engineers
 AFFX: Eng_Hires(4)
 UNITS: months

The attrition rate of engineers is equal to the current stock of engineers divided by the average duration of employment, assumed to be five years.

5: $\text{Eng_Attrition} = \text{Product_Development_Engineers} / \text{Avg_Duration_of_Employment}$

DEFN: Attrition in the Engineering Staff
 USES: Avg_Duration_of_Employment(6) Product_Development_Engineers(3)

AFFX: Product_Development_Engineers(3) Replacement_Engineer_Hires(12)
 UNITS: engineers/month

6: Avg_Duration_of_Employment = 60

DEFN: Average Duration of Employment for Product Development Engineers
 AFFX: Eng_Attrition(5)
 UNITS: months

1.1.3 Maximum Product Development Capacity

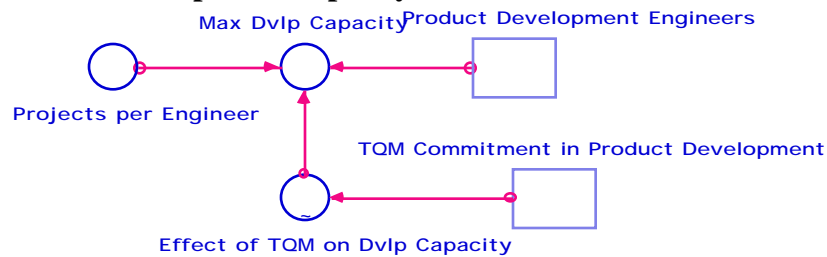

The maximum product development capacity, measured in terms of product development projects, is defined as the maximum number of product development projects in which the development staff that can be actively involved at any moment in time. It is determined by the product of three quantities: the current stock of development engineers, the number of projects that each engineer can work on at any moment in time, and the current level of commitment to Total Quality Management in the product development area.

10: Max_Dvlp_Capacity =
 $\text{Product_Development_Engineers} * \text{Projects_per_Engineer} * \text{Effect_of_TQM_on_Dvlp_Capacity}$

DEFN: Maximum Product Development Capacity
 USES: Effect_of_TQM_on_Dvlp_Capacity(16) Product_Development_Engineers(3)
 Projects_per_Engineer(11)
 AFFX: Layout_and_Mask_Bkth(17) Layout_and_Mask_Ext(20) Prd_Design_Ext(25)
 Product_Design_Bkth(28) Wafer_Fab_Bkth(31) Wafer_Fab_Ext(34) Slack_Dvlp_Capacity(50)
 UNITS: product development projects

The number of projects in which an individual engineer can be actively involved is set to four based upon interview data [Kress 1992]. The construct Commitment to TQM in Product Development, which will be discussed in detail in a subsequent section (#5), is defined over the zero-one interval and measures the percent of PD engineers that actively participate in TQM related activities. Through a graphical function it inversely affects the maximum development capacity. The function is assumed to be decreasing and convex. As PD engineers spend more time on quality related activities, the time they spend on actual product development decreases. It is assumed the full commitment to TQM causes a 20% reduction in development capacity.

11: Projects_per_Engineer = 4

DEFN: Development Projects Per Engineer
 AFFX: Max_Dvlp_Capacity(10)

UNITS: product development projects/engineer

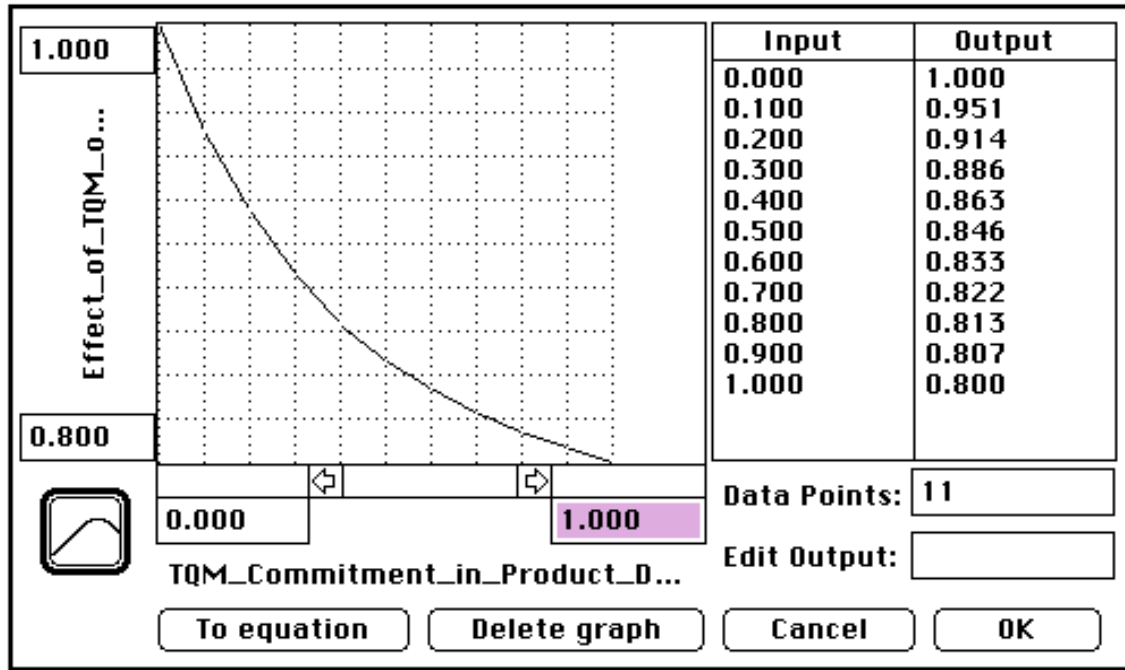

16: Effect_of_TQM_on_Dvlp_Capacity = GRAPH(TQM_Commitment_in_Product_Development)
 DATA: (0.00, 1.00), (0.1, 0.951), (0.2, 0.914), (0.3, 0.886), (0.4, 0.863), (0.5, 0.846), (0.6, 0.833), (0.7, 0.822), (0.8, 0.813), (0.9, 0.807), (1, 0.8)

DEFN: The Effect of the Use of TQM on the Maximum Product Development Capacity
 USES: TQM_Commitment_in_Product_Development(273)
 AFFX: Max_Dvlp_Capacity(10)
 UNITS: dimensions

1.2 Product Development

1.2.1 The Product Development Chain

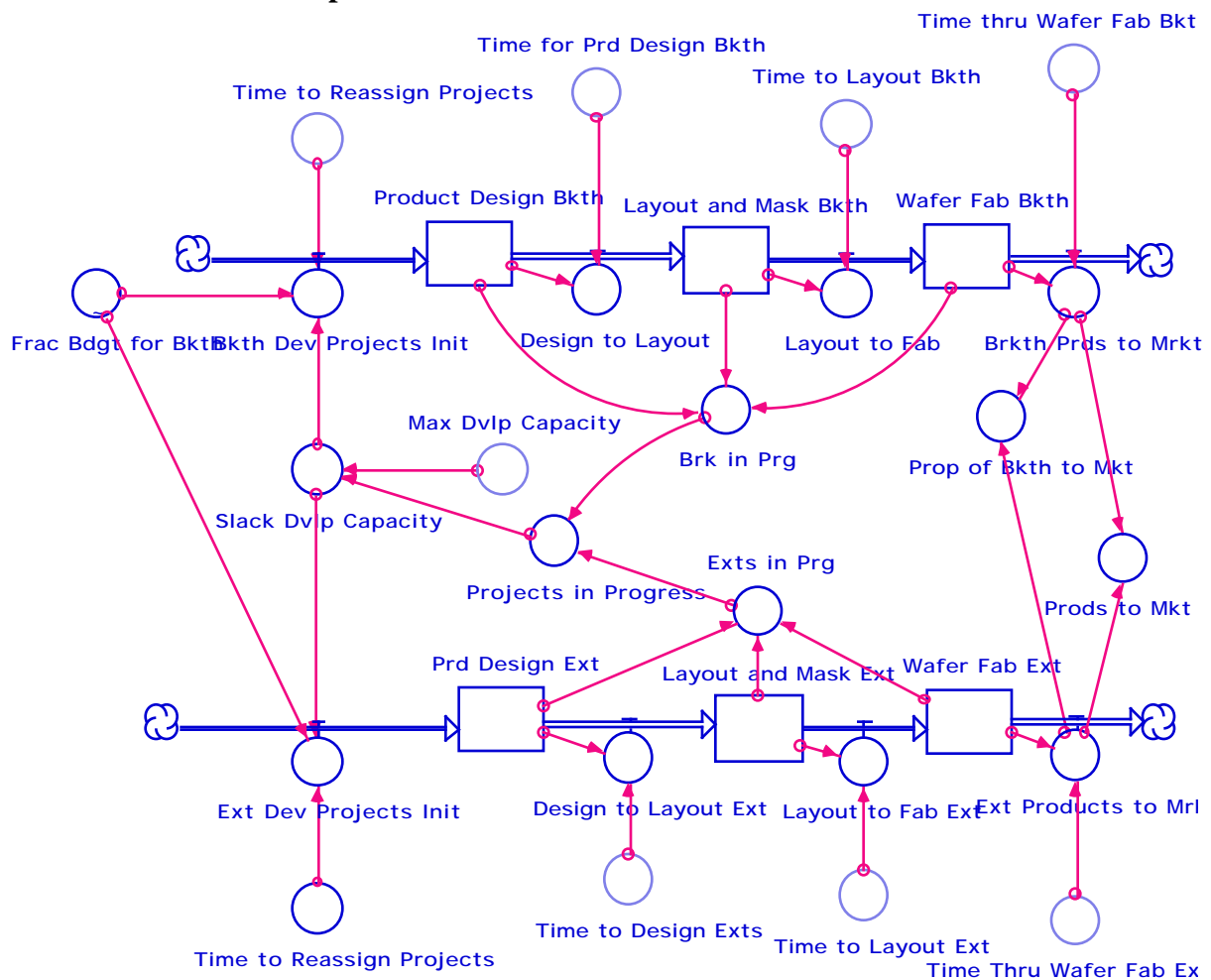

A third order material delay is used to represent the core product development process. New projects are initiated as other development projects are completed and development capacity becomes available. The initiation of new projects focused on developing breakthrough products is determined by the current slack in development capacity multiplied by the fraction of the development effort that is dedicated to breakthrough products. There is also a delay in re-allocating resources to new projects. The fraction of the budget allocated to breakthrough products is discussed in section 1.2.3. The amount of slack development capacity is equal to the maximum develop capacity, described in the previous section, minus the number of products currently under development.

$$29: \text{Bkth_Dev_Projects_Init} = (\text{Frac_Bdgt_for_Bkth} * \text{Slack_Dvlp_Capacity}) / \text{Time_to_Reassign_Projects}$$

DEFN: Breakthrough Development Projects Initiated

USES: Frac_Bdgt_for_Bkth(61) Slack_Dvlp_Capacity(50) Time_to_Reassign_Projects(58)
 AFFX: Product_Design_Bkth(28)
 UNITS: development projects/month

50: $\text{Slack_Dvlp_Capacity} = \text{Max}(\text{Max_Dvlp_Capacity} - \text{Projects_in_Progress}, 0)$

DEFN: Unused Product Development Capacity
 USES: Max_Dvlp_Capacity(10) Projects_in_Progress(47)
 AFFX: Ext_Dev_Projects_Init(26) Bkth_Dev_Projects_Init(29)
 UNITS: development projects

47: $\text{Projects_in_Progress} = \text{Exts_in_Prg} + \text{Brk_in_Prg}$

DEFN: Development Projects in Progress
 USES: Brk_in_Prg(38) Exts_in_Prg(40)
 AFFX: Slack_Dvlp_Capacity(50)
 UNITS: development projects

58: $\text{Time_to_Reassign_Projects} = 1$

DEFN: Time Required to Re-Assign Resources to New Development Projects
 AFFX: Ext_Dev_Projects_Init(26) Bkth_Dev_Projects_Init(29)
 UNITS: months

The initiation rate for line extension development projects is formulated similarly.

26: $\text{Ext_Dev_Projects_Init} = (1 - \text{Frac_Bdgt_for_Bkth}) * \text{Slack_Dvlp_Capacity} / \text{Time_to_Reassign_Projects}$

DEFN: Line Extension Development Projects Initiated
 USES: Frac_Bdgt_for_Bkth(61) Slack_Dvlp_Capacity(50) Time_to_Reassign_Projects(58)
 AFFX: Prd_Design_Ext(25)
 UNITS: development projects/month

Once projects are initiated they proceed to the design phase. Once the design has been completed, the product moves to the second stage of development, layout and masking. The rate of transfer between design and layout is equal to the number of projects in the design phase divided by the average time required to design a product.

28: $\text{Product_Design_Bkth} = \text{Product_Design_Bkth} * (t - dt) + (\text{Bkth_Dev_Projects_Init} - \text{Design_to_Layout}) * dt$
 INIT: $(.66 * \text{Max_Dvlp_Capacity}) * \text{Prct_Dvlp_Time_to_Prd_Design}$

DEFN: Breakthrough Development Projects in the Design Phase
 USES: Bkth_Dev_Projects_Init(29) Design_to_Layout(18) Max_Dvlp_Capacity(10)
 Prct_Dvlp_Time_to_Prd_Design(42)
 AFFX: Design_to_Layout(18) Design_to_Layout(30) Brk_in_Prg(38)
 UNITS: breakthrough development projects

30: $\text{Design_to_Layout} = \text{Product_Design_Bkth} / \text{Time_for_Prd_Design_Bkth}$

DEFN: Breakthrough Development Projects Moving from Design to Layout

USES: Product_Design_Bkth(28) Time_for_Prd_Design_Bkth(51)
 UNITS: breakthrough development projects/month

25: $Prd_Design_Ext = Prd_Design_Ext * (t-dt) + (Ext_Dev_Projects_Init - Design_to_Layout_Ext) * dt$
 INIT: $.34 * Max_Dvlp_Capacity * Prct_Dvlp_Time_to_Prd_Design$

DEFN: Extension Development Projects in the Design Phase
 USES: Design_to_Layout_Ext(21) Ext_Dev_Projects_Init(26) Max_Dvlp_Capacity(10)
 Prct_Dvlp_Time_to_Prd_Design(42)
 AFFX: Design_to_Layout_Ext(21) Design_to_Layout_Ext(27) Exts_in_Prg(40)
 UNITS: breakthrough development projects

27: $Design_to_Layout_Ext = Prd_Design_Ext / Time_to_Design_Exts$

DEFN: Extension Development Projects Moving from Design to Layout
 USES: Prd_Design_Ext(25) Time_to_Design_Exts(55)
 UNITS: breakthrough development projects/month

Once the layout and masking phase is completed, development projects move to the testing phase. The rate of transfer is also determined by a first order process; specifically the number of projects in the layout and mask phase divided by the average time required to layout and mask one project.

17: $Layout_and_Mask_Bkth = Layout_and_Mask_Bkth * (t-dt) + (Design_to_Layout - Layout_to_Fab) * dt$
 INIT: $.66 * Max_Dvlp_Capacity * Prct_Prd_Dvlp_Time_to_Layout$

DEFN: Breakthrough Development Projects in the Layout and Masking Phase
 USES: Design_to_Layout(18) Layout_to_Fab(19) Layout_to_Fab(32) Max_Dvlp_Capacity(10)
 Prct_Prd_Dvlp_Time_to_Layout(45)
 AFFX: Layout_to_Fab(19) Layout_to_Fab(32) Brk_in_Prg(38)
 UNITS: product development project

19: $Layout_to_Fab = Layout_and_Mask_Bkth / Time_to_Layout_Bkth$

DEFN: Breakthrough Development Projects Moving from Layout to Fab Testing
 USES: Layout_and_Mask_Bkth(17) Time_to_Layout_Bkth(56)
 AFFX: Layout_and_Mask_Bkth(17) Wafer_Fab_Bkth(31)
 UNITS: product development projects/month

20: $Layout_and_Mask_Ext = Layout_and_Mask_Ext * (t-dt) + (Design_to_Layout_Ext - Layout_to_Fab_Ext) * dt$
 INIT: $.34 * Max_Dvlp_Capacity * Prct_Prd_Dvlp_Time_to_Layout$

DEFN: Extension Development Projects in the Layout and Masking Phase
 USES: Design_to_Layout_Ext(21) Layout_to_Fab_Ext(22) Max_Dvlp_Capacity(10)
 Prct_Prd_Dvlp_Time_to_Layout(45)
 AFFX: Layout_to_Fab_Ext(22) Layout_to_Fab_Ext(35) Exts_in_Prg(40)
 UNITS: product development projects

22: $Layout_to_Fab_Ext = Layout_and_Mask_Ext / Time_to_Layout_Ext$

DEFN: Extension Development Projects Moving from Layout to Fab Testing

USES: Layout_and_Mask_Ext(20) Time_to_Layout_Ext(57)
 AFFX: Layout_and_Mask_Ext(20) Wafer_Fab_Ext(34)
 UNITS: product development projects/month

Once the testing process process is completed the products are introduced to the market. The rate of product completion and introduction to the market is equal to the number of products in the testing phase divided by the average time required to complete the testing phase.

31: $Wafer_Fab_Bkth = Wafer_Fab_Bkth * (t-dt) + (Layout_to_Fab - Brkth_Prds_to_Mrkt) * dt$
 INIT: $.66 * Max_Dvlp_Capacity * Prct_Dvp_Time_to_Wafer_Fab$

DEFN: Breakthrough Development Projects in the Fabrication Testing Phase
 USES: Brkth_Prds_to_Mrkt(33) Layout_to_Fab(19) Layout_to_Fab(32) Max_Dvlp_Capacity(10)
 Prct_Dvp_Time_to_Wafer_Fab(43)
 AFFX: Brkth_Prds_to_Mrkt(33) Brk_in_Prg(38)
 UNITS: product development projects

33: $Brkth_Prds_to_Mrkt = Wafer_Fab_Bkth / Time_thru_Wafer_Fab_Bkth$

DEFN: Breakthrough Products Introduced to the Market
 USES: Time_thru_Wafer_Fab_Bkth(52) Wafer_Fab_Bkth(31)
 AFFX: Wafer_Fab_Bkth(31) Prods_to_Mkt(46) Prop_of_Bkth_to_Mkt(48) New_Prdct_Intros(73)
 Chng_in_Tot_Prds_Intro(630)
 UNITS: product development projects/month

34: $Wafer_Fab_Ext = Wafer_Fab_Ext * (t-dt) + (Layout_to_Fab_Ext - Ext_Products_to_Mrkt) * dt$
 INIT: $.34 * Max_Dvlp_Capacity * Prct_Dvp_Time_to_Wafer_Fab$

DEFN: Extension Development Projects in the Fabrication Testing Phase
 USES: Ext_Products_to_Mrkt(36) Layout_to_Fab_Ext(22) Max_Dvlp_Capacity(10)
 Prct_Dvp_Time_to_Wafer_Fab(43)
 AFFX: Ext_Products_to_Mrkt(36) Exts_in_Prg(40)
 UNITS: product development projects

36: $Ext_Products_to_Mrkt = Wafer_Fab_Ext / Time_Thru_Wafer_Fab_Ext$

DEFN: Extension Products Introduced to the Market
 USES: Time_Thru_Wafer_Fab_Ext(53) Wafer_Fab_Ext(34)
 AFFX: Wafer_Fab_Ext(34) Prods_to_Mkt(46) Prop_of_Bkth_to_Mkt(48) New_Line_Extension_Mrkt(66)
 Chng_in_Tot_Prds_Intro(630)
 UNITS: product development projects/month

The total number of breakthrough projects in progress is equal to the sum of the number of products in each of the three development phases.

38: $Brk_in_Prg = Product_Design_Bkth + Layout_and_Mask_Bkth + Wafer_Fab_Bkth$

DEFN: Total Breakthrough Development Projects in Progress
 USES: Layout_and_Mask_Bkth(17) Product_Design_Bkth(28) Wafer_Fab_Bkth(31)
 AFFX: Brkth_Frac(37) Projects_in_Progress(47)
 UNITS: product development projects

40: $Exts_in_Prg = Prd_Design_Ext + Layout_and_Mask_Ext + Wafer_Fab_Ext$

DEFN: Total Extension Development Projects in Progress
USES: Layout_and_Mask_Ext(20) Prd_Design_Ext(25) Wafer_Fab_Ext(34)
AFFX: Brkth_Frac(37) Projects_in_Progress(47)
UNITS: product development projects

The total number of products released on the market is the sum of the breakthrough products introduced and the line extension products introduced.

$$46: \text{Prods_to_Mkt} = \text{Brkth_Prds_to_Mrkt} + \text{Ext_Products_to_Mrkt}$$

DEFN: Total Products Introduced to the Market
USES: Brkth_Prds_to_Mrkt(33) Ext_Products_to_Mrkt(36)
AFFX: Product_to_market_In(621)
UNITS: products/month

The fraction of breakthrough products introduced is the ratio breakthrough introductions to total product introductions.

$$48: \text{Prop_of_Bkth_to_Mkt} = \text{Brkth_Prds_to_Mrkt} / (\text{Brkth_Prds_to_Mrkt} + \text{Ext_Products_to_Mrkt})$$

DEFN: Fraction of Product Introduced to the Market that are Breakthroughs
USES: Brkth_Prds_to_Mrkt(33) Ext_Products_to_Mrkt(36)
UNITS: dimensionless

1.2.2 Partitioning Product Development Time

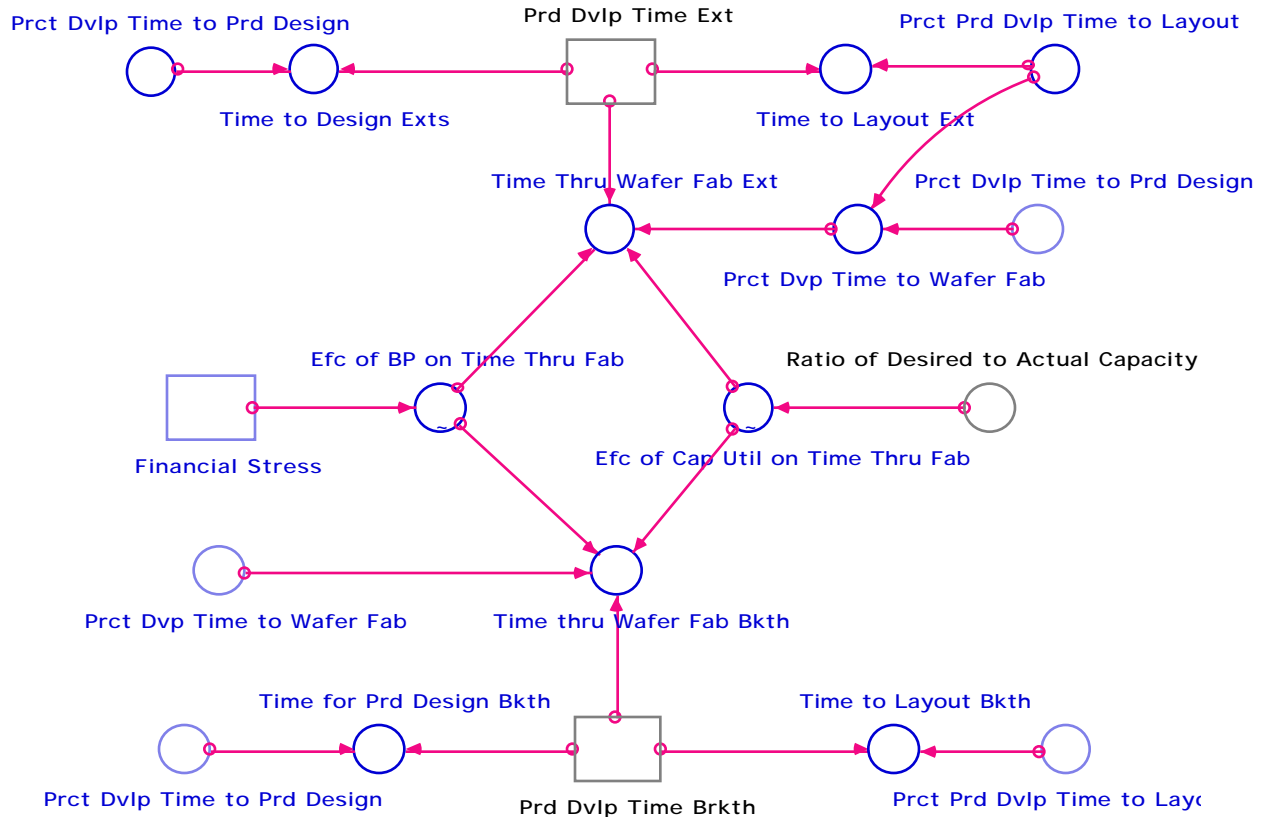

The structure described in this sub-section determines the average time that a development project spends in each phase of the development process. The indicated total development time for both breakthrough and line extension products is determined in the improvement sector (#4). The indicated development time represents the nominal time required to develop each type of product on average. The actual time required for both types of product to go through the first phase, the design process, is equal to the indicated total development time for each type of product multiplied by the fraction of the total development time required by the design process. This fraction is set to 40% based upon data obtained through interviews [Kress 1992].

$$51: \text{Time_for_Prd_Design_Bkth} = \text{Prd_Dvlp_Time_Brkth} * \text{Prct_Dvlp_Time_to_Prd_Design}$$

DEFN: Time Required for Breakthrough Projects to Complete the Design Phase

USES: Prct_Dvlp_Time_to_Prd_Design(42) Prd_Dvlp_Time_Brkth(222)

AFFX: Design_to_Layout(18) Design_to_Layout(30)

UNITS: months

$$55: \text{Time_to_Design_Exts} = \text{Prd_Dvlp_Time_Ext} * \text{Prct_Dvlp_Time_to_Prd_Design}$$

DEFN: Time Required for Extension Projects to Complete the Design Phase
 USES: Prct_Dvlp_Time_to_Prd_Design(42) Prd_Dvlp_Time_Ext(225)
 AFFX: Design_to_Layout_Ext(21) Design_to_Layout_Ext(27)
 UNITS: months

42: Prct_Dvlp_Time_to_Prd_Design = .4

DEFN: Fraction of Total Development Time Resulting From Product Design
 AFFX: Prd_Design_Ext(25) Product_Design_Bkth(28) Prct_Dvp_Time_to_Wafer_Fab(43)
 Time_for_Prd_Design_Bkth(51) Time_to_Design_Exts(55)
 UNITS: dimensionless

The time required for both types of products to pass through the layout and masking phase is similarly determined. The fraction of the total development time allocated to layout and masking is set to 20%, again based upon information obtained through interview [Kress 1992].

56: Time_to_Layout_Bkth = Prd_Dvlp_Time_Bkth*Prct_Prd_Dvlp_Time_to_Layout

DEFN: Time Required for Breakthrough Products to Complete the Layout and Masking Phase
 USES: Prct_Prd_Dvlp_Time_to_Layout(45) Prd_Dvlp_Time_Bkth(222)
 AFFX: Layout_to_Fab(19) Layout_to_Fab(32)
 UNITS: months

57: Time_to_Layout_Ext = Prd_Dvlp_Time_Ext*Prct_Prd_Dvlp_Time_to_Layout

DEFN: Time Required for Extension Products to Complete the Layout and Masking Phase
 USES: Prct_Prd_Dvlp_Time_to_Layout(45) Prd_Dvlp_Time_Ext(225)
 AFFX: Layout_to_Fab_Ext(22) Layout_to_Fab_Ext(35)
 UNITS: months

45: Prct_Prd_Dvlp_Time_to_Layout = .2

DEFN: Fraction of Total Development Time Resulting From Product Design
 AFFX: Layout_and_Mask_Bkth(17) Layout_and_Mask_Ext(20) Prct_Dvp_Time_to_Wafer_Fab(43)
 Time_to_Layout_Bkth(56) Time_to_Layout_Ext(57)
 UNITS: dimensionless

The time required for the project to complete the testing phase is also based upon a fixed fraction of the total development time. However, this phase has an additional complication. Testing must be done on the same equipment that is used for normal manufacturing operations. As a result, the time required for this portion of product development is influenced by conditions in other areas of the firm. Specifically, interviews with key Analog personnel indicate two important factors: First, if utilization rates are very high, production managers are reluctant to disrupt production schedules with test lots as this increases the probability that on-time delivery targets will not be met. Performance on measures such as On-Time delivery were an important determinant of compensation for Analog managers [Kaplan 1990a]. Second, in periods of financial stress test lots delay the production of revenue producing orders [Kress 1992, Schneiderman 1992]. These effects are operationalized in the equations that determine the time required for a project to pass through the testing phase using two graphical functions. Time through testing is determined by the

fraction of indicated development time multiplied by the effect of utilization and the effect of financial stress.

52: $\text{Time_thru_Wafer_Fab_Bkth} = \text{Prct_Dvp_Time_to_Wafer_Fab} * \text{Prd_Dvlp_Time_Brkth} * \text{Efc_of_BP_on_Time_Thru_Fab} * \text{Efc_of_Cap_Util_on_Time_Thru_Fab}$

DEFN: Time Required for Breakthrough Development Projects to Complete the Testing Phase
 USES: Efc_of_BP_on_Time_Thru_Fab(59) Efc_of_Cap_Util_on_Time_Thru_Fab(60)
 Prct_Dvp_Time_to_Wafer_Fab(43) Prd_Dvlp_Time_Brkth(222)
 AFFX: Brkth_Prds_to_Mrkt(33)
 UNITS: months

53: $\text{Time_Thru_Wafer_Fab_Ext} = \text{Prd_Dvlp_Time_Ext} * \text{Prct_Dvp_Time_to_Wafer_Fab} * \text{Efc_of_BP_on_Time_Thru_Fab} * \text{Efc_of_Cap_Util_on_Time_Thru_Fab}$

DEFN: Time Required for Breakthrough Development Projects to Complete the Testing Phase
 USES: Efc_of_BP_on_Time_Thru_Fab(59) Efc_of_Cap_Util_on_Time_Thru_Fab(60)
 Prct_Dvp_Time_to_Wafer_Fab(43) Prd_Dvlp_Time_Ext(225)
 AFFX: Ext_Products_to_Mrkt(36)
 UNITS: months

43: $\text{Prct_Dvp_Time_to_Wafer_Fab} = 1 - \text{Prct_Prd_Dvlp_Time_to_Layout} - \text{Prct_Dvlp_Time_to_Prd_Design}$

DEFN: Fraction of Total Development Time Required for Testing
 USES: Prct_Dvlp_Time_to_Prd_Design(42) Prct_Prd_Dvlp_Time_to_Layout(45)
 AFFX: Wafer_Fab_Bkth(31) Wafer_Fab_Ext(34) Time_thru_Wafer_Fab_Bkth(52)
 Time_Thru_Wafer_Fab_Ext(53)
 UNITS: dimensionless

The effect of financial stress on the time required for wafers to pass through the testing phase is operationalized as a strictly increasing function with a positive second derivative defined over the interval zero to one. When financial stress is low, close to zero, there is little effect on the time required to test wafers as managers are willing to delay the production of revenue producing orders to aid in the development of new products. However, as financial stress grows, the development time increases as managers become increasingly reluctant to delay the production of units already sold. When financial stress is at its maximum, testing requires double the normal time.

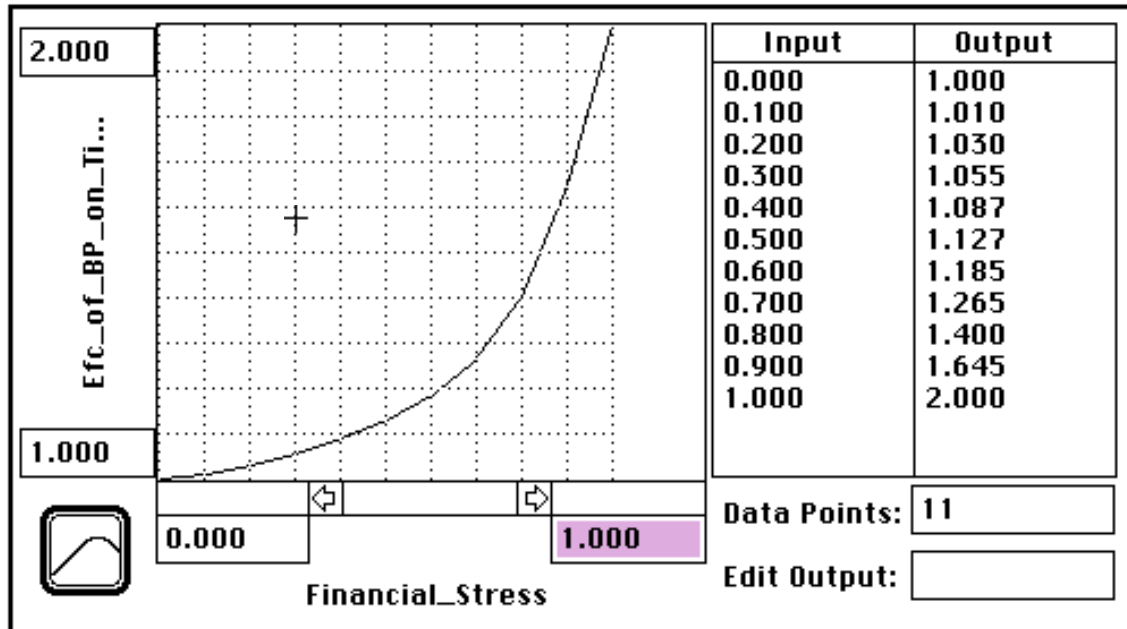

59: Efc_of_BP_on_Time_Thru_Fab = GRAPH(Financial_Stress)
 DATA: (0.00, 1.00), (0.1, 1.01), (0.2, 1.03), (0.3, 1.05), (0.4, 1.09), (0.5, 1.13), (0.6, 1.19), (0.7, 1.26), (0.8, 1.40), (0.9, 1.65), (1, 2.00)

DEFN: The Effect of Financial Stress on Time Required to Complete the Testing Phase

USES: Financial_Stress(552)

AFFX: Time_thru_Wafer_Fab_Bkth(52) Time_Thru_Wafer_Fab_Ext(53)

UNITS: dimensionless

The effect of capacity utilization on the time required for development projects to pass through the testing phase is also operationalized as a strictly increasing, convex, function. The domain of the function is the interval between .8 and 2. Disruption of production schedules can significantly degrade performance on such key measures as manufacturing cycle time, product lead time, and on-time delivery. As the ratio of desired to actual wafers starts increases beyond one, production managers are assumed to become increasingly unwilling to disrupt the already tight production schedule with test lots. As previously mentioned, the on-time delivery percentage played an important role in the division managers' performance evaluations [Kaplan 1990a]. At a ratio of two, demand is twice the available capacity, the testing time is assumed to be three times the normal value.

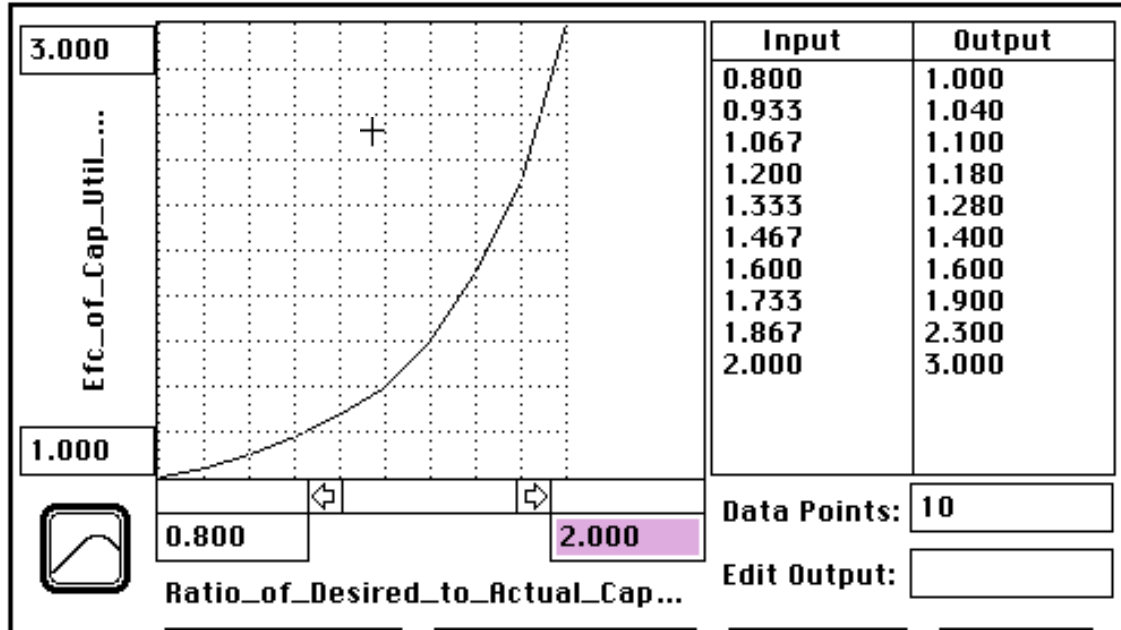

60: Efc_of_Cap_Util_on_Time_Thru_Fab = GRAPH(Ratio_of_Desired_to_Actual_Capacity)
 DATA: (0.8, 1.00), (0.933, 1.04), (1.07, 1.10), (1.20, 1.18), (1.33, 1.28), (1.47, 1.40), (1.60, 1.60), (1.73, 1.90), (1.87, 2.30), (2.00, 3.00)

DEFN: Effect of Capacity Utilization on the Time Required to Complete the Testing Phase

USES: Ratio_of_Desired_to_Actual_Capacity(181)

AFFX: Time_thru_Wafer_Fab_Bkth(52) Time_Thru_Wafer_Fab_Ext(53)

UNITS: dimensionless

1.2.3 Fraction of Budget to Breakthrough Products

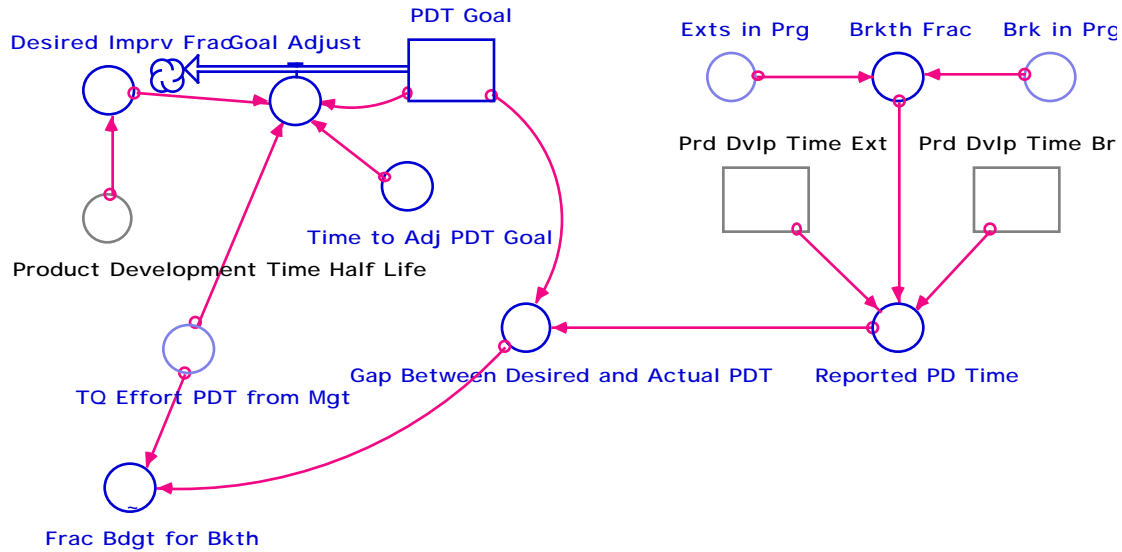

The final element required to complete the specification of the sector for product development is the fraction of the development effort focused on breakthrough products. This fraction is a critical determinant of the reported product development time. Breakthrough products generally involve new and unproven technology, and, as a result, the time required to develop them is much greater than that required to develop line extension products [Kress 1992]. If the product development time metric does not differentiate between the two types of products, as was the case at Analog, then the reported product time to market can be decreased by reducing the fraction of effort dedicated to the development of breakthrough products. As a result, the fraction of effort dedicated to breakthrough products is assumed to be a function of the gap between the desired product development time and the reported development time. As the gap increases, more effort will be allocated to line extension products. This effect will be mitigated by management's current attention to improvement in the PD area.

The normal fraction of effort dedicated to breakthrough products is assumed to be sixty percent based upon information taken from interviews with Analog personnel [Kress 1992]. This fraction declines as the gap between the desired and actual product development time grows, as the gap approaches eight months, the function approaches 33%.

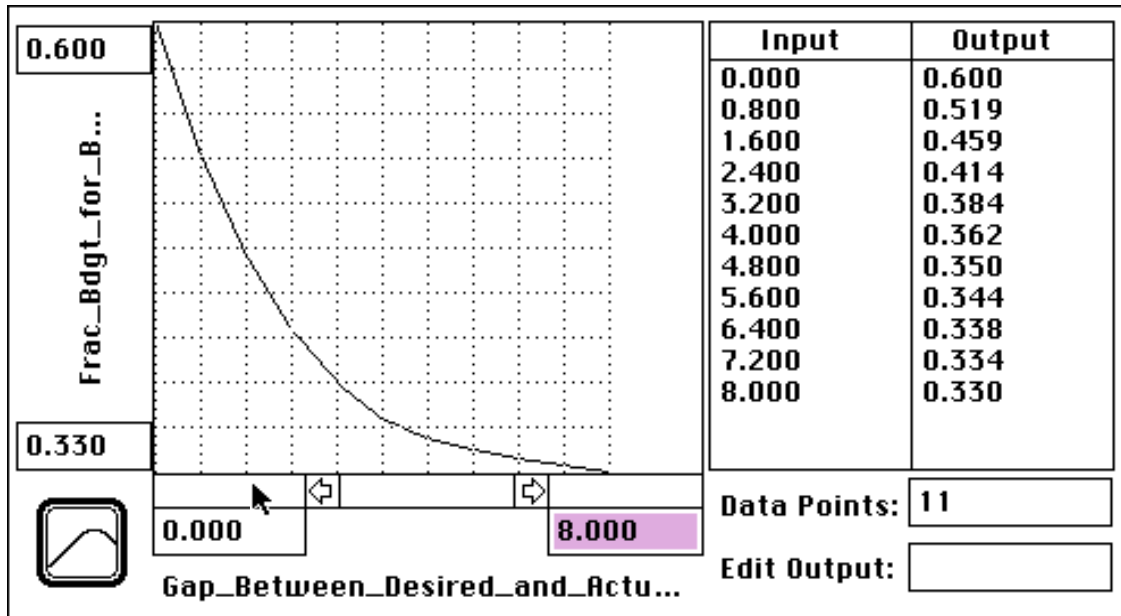

61: Frac_Bdgt_for_Bkth =
 GRAPH(Gap_Between_Desired_and_Actual_PDT*TQ_Effort_PDT_from_Mgt)
 DATA: (0.00, 0.6), (0.8, 0.519), (1.60, 0.459), (2.40, 0.414), (3.20, 0.384), (4.00, 0.362), (4.80, 0.35),
 (5.60, 0.344), (6.40, 0.338), (7.20, 0.334), (8.00, 0.33)

DEFN: Fraction of the Development Effort Dedicated to Producing Breakthrough Products
 USES: Gap_Between_Desired_and_Actual_PDT(41) TQ_Effort_PDT_from_Mgt(288)
 AFFX: Ext_Dev_Projects_Init(26) Bkth_Dev_Projects_Init(29)
 UNITS: dimensionless

The gap between the desired and actual product development time is calculated as the reported product development time minus the current goal. The change in the product development time goal is determined by the simple half-life equation multiplied by the current commitment to improvement on the part of management. The construct commitment, defined over the zero one interval, is discussed in section #5. The desired improvement fraction is based upon the half-life originally estimated for Analog's product development process. The average time required to adjust the development time goal is assumed to be one month. The reported product development time is an average of the time required to develop breakthrough products and the time required to develop line extension products weighted by the fraction that each type of project occupies in the total stock of projects.

41: Gap_Between_Desired_and_Actual_PDT = Reported_PD_Time-PDT_Goal

DEFN: The Gap Between the Desired and Actual Product Development Time
 USES: PDT_Goal(23) Reported_PD_Time(49)
 AFFX: Frac_Bdgt_for_Bkth(61)
 UNITS: months

23: $PDT_Goal = PDT_Goal * (t-dt) + (- Goal_Adjust) * dt$
 INIT: Reported_PD_Time

DEFN: Goal for Product Development Time
 USES: Goal_Adjust(24) Reported_PD_Time(49)
 AFFX: Goal_Adjust(24) Gap_Between_Desired_and_Actual_PDT(41)
 UNITS: months

24: Goal_Adjust =
 $((PDT_Goal * (Desired_Imprv_Frac)) / Time_to_Adj_PDT_Goal) * TQ_Effort_PDT_from_Mgt$

DEFN: Adjustment in the Goal for Product Development Time
 USES: Desired_Imprv_Frac(39) PDT_Goal(23) Time_to_Adj_PDT_Goal(54)
 TQ_Effort_PDT_from_Mgt(288)
 AFFX: PDT_Goal(23)
 UNITS: months/month

54: Time_to_Adj_PDT_Goal = 1

DEFN: Average Time Required for Changes in the Goal for Product Development Time
 AFFX: Goal_Adjust(24)
 UNITS: months

39: $Desired_Imprv_Frac = 1 / (Product_Development_Time_Half_Life / (LOGN(2)))$

DEFN: Desired Fractional Improvement Rate in Product Development Time
 USES: Product_Development_Time_Half_Life(263)
 AFFX: Goal_Adjust(24)
 UNITS: dimensionless

49: $Reported_PD_Time = (Prd_Dvlp_Time_Brkth * Brkth_Frac) + (Prd_Dvlp_Time_Ext * (1 - Brkth_Frac))$

DEFN: Reported Product Development Time
 USES: Brkth_Frac(37) Prd_Dvlp_Time_Brkth(222) Prd_Dvlp_Time_Ext(225)
 AFFX: PDT_Goal(23) Gap_Between_Desired_and_Actual_PDT(41) Historical_PDT(234)
 PDT_Improvement_Rate(251)
 UNITS: months

37: $Brkth_Frac = Brk_in_Prg / (Exts_in_Prg + Brk_in_Prg)$

DEFN: Fraction of Total Development Projects Dedicated to Breakthrough Products
 USES: Brk_in_Prg(38) Exts_in_Prg(40)
 AFFX: Reported_PD_Time(49)
 UNITS: dimensionless

2. The Market for Analog's Products

2.0 Overview

The equations in this sector determine Analog's monthly unit sales. The sector takes as its major inputs new product introductions (from the product development sector), price (from the pricing sector), and quality and performance measures, such as product defects and on-time delivery (from the improvement sector). It is divided into three basic sub-sectors. The first determines the size of the potential market for Analog's products, the second determines Analog's share of that potential market, and the third multiplies the first two to determine Analog's unit sales.

2.1 The Size of the Market

2.1.1 Breakthrough Products and the Potential Market

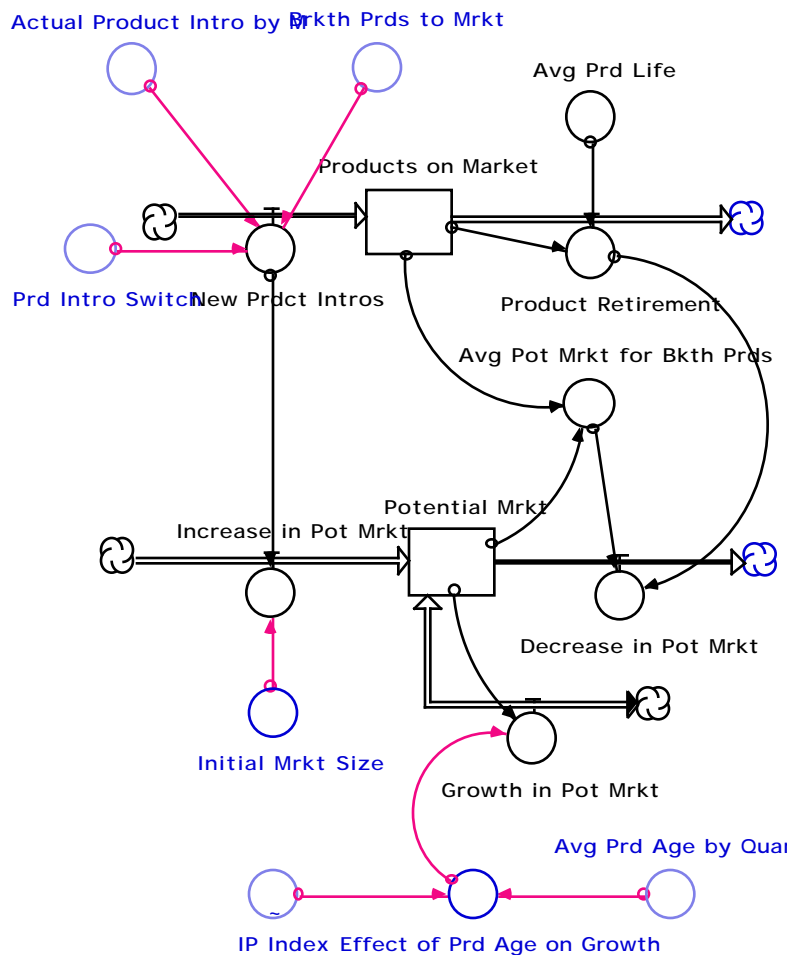

The size of the potential market is determined by Analog's current product portfolio, the average age of products in that portfolio, and an index representing the effects of the larger macro-economy on industry. The number of products in the portfolio is increased by product introductions,

determined in the previous sector, and decreased by product retirements. The rate of product retirement is equal to the current number of products on the market divided by the average product life. The average product life is set to ten years based upon data collected from interviews and an estimate made using Analog's product performance database [Stata 1993, Analog Devices 1992, Schneiderman 1992]. The initial value is set to two hundred products based upon an estimate made by the authors using data taken from Analog's product performance database.

72: $Products_on_Market = Products_on_Market * (t-dt) + (New_Prdct_Intros - Product_Retirement) * dt$
INIT: 200

DEFN: Breakthrough Products on the Market

USES: New_Prduct_Intros(73) Product_Retirement(74)

AFFX: Cumulative_Product_Age(62) Increase_in_Product_Age(63) Product_Retirement(74)

Average_Product_Age(75) Avg_Pot_Mrkt_for_Bkth_Prds(76)

UNITS: products

73: $New_Prdct_Intros = (Brkth_Prds_to_Mrkt * (1 - Prd_Intro_Switch)) + (Actual_Product_Intro_by_M * .5 * Prd_Intro_Switch)$

DEFN: New Breakthrough Products Introduced on the Market

USES: Actual_Product_Intro_by_M(643) Brkth_Prds_to_Mrkt(33) Prd_Intro_Switch(664)

AFFX: Increase_in_Pot_Mrkt(69) Products_on_Market(72)

UNITS: products/month

74: $Product_Retirement = Products_on_Market / Avg_Prd_Life$

DEFN: Breakthrough Products Removed From the Market

USES: Avg_Prd_Life(78) Products_on_Market(72)

AFFX: Decrease_in_Product_Age(64) Decrease_in_Pot_Mrkt(71) Products_on_Market(72)

UNITS: products/month

78: $Avg_Prd_Life = 120$

DEFN: Average Life of Breakthrough Products

AFFX: Product_Retirement(74)

UNITS: months

The potential market associated with the product portfolio is determined by a modified co-flow structure. As each new product is introduced the potential market is increased by a fixed amount, the Initial Market Size. This represent that initial sales associated with the introduction of a new product. The value of this constant was estimated by taking the average of the first month's sales for each product in Analog's product performance database for the years 1980 through 1990.

68: $Potential_Mrkt = Potential_Mrkt * (t-dt) + (Increase_in_Pot_Mrkt + Growth_in_Pot_Mrkt - Decrease_in_Pot_Mrkt) * dt$

INIT: 1.275*Actual_Unit_Sales_by_Y/12

DEFN: Potential Market for Breakthrough Products

USES: Actual_Unit_Sales_by_Y(683) Decrease_in_Pot_Mrkt(71) Growth_in_Pot_Mrkt(70)
Increase_in_Pot_Mrkt(69)

AFFX: Growth_in_Pot_Mrkt(70) Avg_Pot_Mrkt_for_Bkth_Prds(76) Total_Potential_Mrkt(112)

UNITS: wafers sold/month

69: Increase_in_Pot_Mrkt = New_Prduct_Intros*Initial_Mrkt_Size

DEFN: Increase in the Potential Market for Breakthrough Products

USES: Initial_Mrkt_Size(80) New_Prduct_Intros(73)

AFFX: Potential_Mrkt(68)

UNITS: wafers sold/month/month

80: Initial_Mrkt_Size = 750

DEFN: Inital Size of the Potential Market for a Breakthrough Product

AFFX: Increase_in_Pot_Mrkt(69)

UNITS: wafers sold/month/product

The potential market for Analog's product's in reduced as product are retired. Following the standard co-flow structure, as products are removed from the market the potential market is reduced by an amount equal to the current average potential market per product. The average market per product is calculated as the total potential market divided by the number of breakthrough products.

71: Decrease_in_Pot_Mrkt = Product_Retirement*Avg_Pot_Mrkt_for_Bkth_Prds

DEFN: Decrease in the Potential Market for Breakthrough Products

USES: Avg_Pot_Mrkt_for_Bkth_Prds(76) Product_Retirement(74)

AFFX: Potential_Mrkt(68)

UNITS: wafers sold/month/month

76: Avg_Pot_Mrkt_for_Bkth_Prds = Potential_Mrkt/Products_on_Market

DEFN: Average Potential Market Per Breakthrough Product

USES: Potential_Mrkt(68) Products_on_Market(72)

AFFX: Decrease_in_Pot_Mrkt(71) Potential_Mrkt_for_Ext_Prds(82)

UNITS: wafers sold/month/product

2.1.2 Growth in the Potential Market

The potential market for Analog's products is also increased/decreased by growth. The model assumes that growth is a function of the average age of the product portfolio and the current state of the macro-economy. The structure determining the average age of the product portfolio is discussed below. The equation that determines the growth rate as a function of product age is assumed to be of the form ;

$$g_{i,A,t} = + (A_{i,t}) + g^e_{t+ t}$$

where $g_{i,A,t}$ is the growth rate at time t for product i , $A_{i,t}$ is the age of the product i at time t , g is an index representing the macro-economy, and ϵ_t is a stochastic disturbance term. The coefficients were estimate using non-linear least squares with data taken from Analog's product performance database. The database contains annual unit sales for every product introduced from 1970 through 1990. As the figure below shows, all coefficients are significant at standard levels except for the macro-economy index. Absent compelling evidence to the contrary we assume that $\beta = 1$. The shape of the estimated curve is shown below. The equation is implemented in the model as estimated with the annual growth rate adjusted for the monthly time scale of the model.

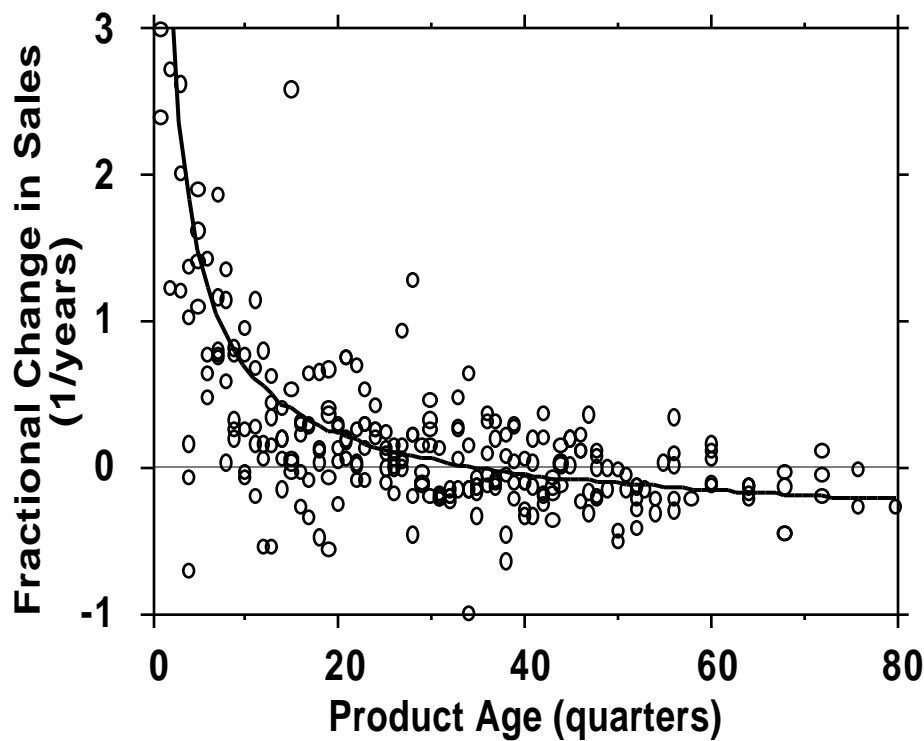

$$\text{Model: } g_{i,A,t} = \beta + \gamma(A_{i,t}) + g^e_t + \epsilon_t$$

<u>Parameter</u>	<u>Estimated Coefficient</u>	<u>Asymptotic Standard. Error</u>
	-.465	.178
	6.413	.407
	-.743	.088
	.052	.914

$$\overline{R^2} = .51, N = 270.$$

70: $\text{Growth_in_Pot_Mrkt} = \text{Potential_Mrkt} * \text{Effect_of_Prd_Age_on_Growth}$

DEFN: Growth in the Potential Market for Breakthrough Products

USES: $\text{Effect_of_Prd_Age_on_Growth}(79)$ $\text{Potential_Mrkt}(68)$

AFFX: $\text{Potential_Mrkt}(68)$

UNITS: wafers sold/month/month

79: $\text{Effect_of_Prd_Age_on_Growth} = (1 - .465 + 6.413 * ((\text{Avg_Prd_Age_by_Quarter})^{(-.743)} + \text{IP_Index})^{(1/12)} - 1)$

DEFN: The Effect of Average Product Age on Growth in the Potential Market

USES: $\text{Avg_Prd_Age_by_Quarter}(77)$ $\text{IP_Index}(691)$

AFFX: $\text{Growth_in_Pot_Mrkt}(70)$

UNITS: 1/months

2.1.3 Average Age of the Product Portfolio

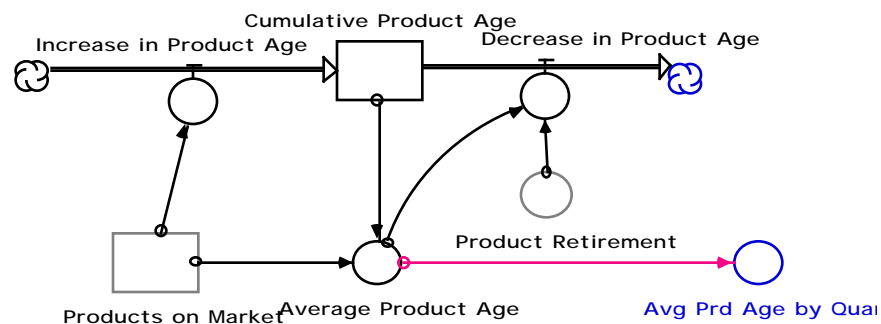

The average age of the product portfolio is also calculated using a modified co-flow structure. For each month that products are on the market, the cumulative age of products on the market is increased by one month for each product. The average age of the portfolio is calculated by dividing the cumulative age of products on the market by the number of products currently in the portfolio.

62: $\text{Cumulative_Product_Age} = \text{Cumulative_Product_Age} * (t - dt) + (\text{Increase_in_Product_Age} - \text{Decrease_in_Product_Age}) * dt$

INIT: $\text{Products_on_Market} * 65$

DEFN: Cumulative Age of Products on the Market

USES: $\text{Decrease_in_Product_Age}(64)$ $\text{Increase_in_Product_Age}(63)$ $\text{Products_on_Market}(72)$

AFFX: $\text{Average_Product_Age}(75)$

UNITS: months

63: $\text{Increase_in_Product_Age} = \text{Products_on_Market}$

DEFN: Increase in the Cumulative Age of Products on the Market

USES: $\text{Products_on_Market}(72)$

AFFX: $\text{Cumulative_Product_Age}(62)$

UNITS: months/month

$$75: \text{Average_Product_Age} = \text{Cumulative_Product_Age}/(\text{Products_on_Market})$$

DEFN: Average Age of Product on the Market

USES: Cumulative_Product_Age(62) Products_on_Market(72)

AFFX: Decrease_in_Product_Age(64) Avg_Prd_Age_by_Quarter(77)

UNITS: months/product

As products are retired and removed from the portfolio the cumulative age of the portfolio is reduced by the current average age of the portfolio.

$$64: \text{Decrease_in_Product_Age} = (\text{Product_Retirement}) * \text{Average_Product_Age}$$

DEFN: Decrease in the Cumulative Age of Products on the Market

USES: Average_Product_Age(75) Product_Retirement(74)

AFFX: Cumulative_Product_Age(62)

UNITS: months/month

For the purpose of determining the growth rate of the potential market, the average age of the portfolio is converted from a monthly to a quarterly scale since the growth equation was estimated with the independent variable measured in quarters.

$$77: \text{Avg_Prd_Age_by_Quarter} = \text{Average_Product_Age}/3$$

DEFN: Average Age of Products on the Market Measured in Quarters

USES: Average_Product_Age(75)

AFFX: Effect_of_Prd_Age_on_Growth(79)

UNITS: quarters/product

2.1.4 Line Extension Products

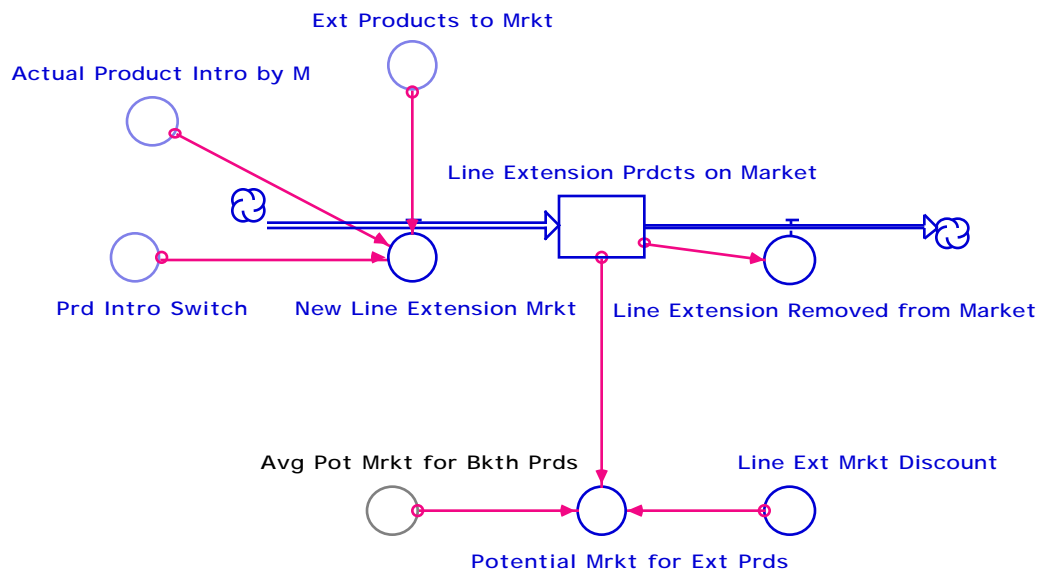

Like breakthrough products, the portfolio of line extension products is increased by introductions and decreased by retirements. New product introductions are determined in the product development sector. Product retirements are determined by dividing the number of line extensions in the portfolio by the average life for line extension products, assumed to be seven and one half years.

65: $\text{Line_Extension_Prdcts_on_Market} = \text{Line_Extension_Prdcts_on_Market} * (t-dt) + (\text{New_Line_Extension_Mrkt} - \text{Line_Extension_Removed_from_Market}) * dt$
INIT: 150

DEFN: Line Extension Products on the Market
USES: Line_Extension_Removed_from_Market(67) New_Line_Extension_Mrkt(66)
AFFX: Line_Extension_Removed_from_Market(67) Potential_Mrkt_for_Ext_Prds(82)
UNITS: products

66: $\text{New_Line_Extension_Mrkt} = (1 - \text{Prd_Intro_Switch}) * \text{Ext_Products_to_Mrkt} + \text{Actual_Product_Intro_by_M} * .5 * \text{Prd_Intro_Switch}$

DEFN: Line Extension Products Introduced to the Market
USES: Actual_Product_Intro_by_M(643) Ext_Products_to_Mrkt(36) Prd_Intro_Switch(664)
AFFX: Line_Extension_Prds_on_Market(65)
UNITS: products/month

67: $\text{Line_Extension_Removed_from_Market} = \text{Line_Extension_Prdcts_on_Market} / 90$

DEFN: Line Extension Products Removed from the Market
USES: Line_Extension_Prds_on_Market(65)
AFFX: Line_Extension_Prds_on_Market(65)
UNITS: product/month

The potential market for line extension products is equal to the number of line extension products on the market multiplied by the average market per breakthrough product multiplied by a discount factor. A line extension, by definition, is a modification of an existing product, and, as a result, already has an existing market. The discount factor represents the fact that a line extension will cannibalize some of the sales currently generated by the parent breakthrough product. The discount for line extension products is assumed to be very small, 5%, based on Analog's position as a manufacturer of integrated circuits specifically designed for use in other manufacturer's products.

82: $\text{Potential_Mrkt_for_Ext_Prds} = \text{Avg_Pot_Mrkt_for_Bkth_Prds} * \text{Line_Extension_Prdcts_on_Market} * \text{Line_Ext_Mrkt_Discount}$

DEFN: Potential Market for Line Extension Products
USES: Avg_Pot_Mrkt_for_Bkth_Prds(76) Line_Ext_Mrkt_Discount(81)
Line_Extension_Prds_on_Market(65)
AFFX: Total_Potential_Mrkt(112)
UNITS: wafers sold/month

81: $\text{Line_Ext_Mrkt_Discount} = .95$

91: $\text{Analog_Indicated_Share_of_Orders} = \text{Product_Attractiveness} / \text{Total_Attractiveness}$

DEFN: Analog's Indicated Share of the Total Potential Market for its Products

USES: Product_Attractiveness(97) Total_Attractiveness(101)

AFFX: Chng_in_Per_Share(84) Analog_Effective_Mrkt_Share(111)

UNITS: dimensionless

92: $\text{Competitor_Share} = \text{Comp_Attract} / \text{Total_Attractiveness}$

DEFN: The Competitor's Share of the Total Potential Market for Analog's Products

USES: Comp_Attract(93) Total_Attractiveness(101)

UNITS: dimensionless.

101: $\text{Total_Attractiveness} = \text{Product_Attractiveness} + \text{Comp_Attract} + 1e-9$

DEFN: Total Attractiveness of the Market

USES: Comp_Attract(93) Product_Attractiveness(97)

AFFX: Analog_Indicated_Share_of_Orders(91) Competitor_Share(92)

UNITS: dimensionless

Five elements are assumed to determine product attractiveness, perceived product defects, perceived product lead times, perceived on time delivery, price and Analog's own market share. Each of these measures is scaled via an attractiveness function. These functions represents the weight or utility that an Analog customer places on a particular element of Analog's product and performance. A multiplicative function is chosen to represent the assumption that a particularly bad performance on any one measure can overwhelm good performance in other areas. As an example, if OTD delivery is extremely poor, it will dominate the effect of above average performance on the other dimensions.

97: $\text{Product_Attractiveness} =$

$(\text{Efc_of_Price_on_Attract} * \text{Efc_of_Perceived_Lead_Time_on_Attract} * \text{Efc_Of_Defects_on_Attract} * \text{Efc_of_Analog_Share_on_Attract} * \text{Efc_of_OTD_on_Attract})$

DEFN: Attractiveness of Analog's Products

USES: Efc_of_Analog_Share_on_Attract(103) Efc_Of_Defects_on_Attract(104)

Efc_of_OTD_on_Attract(107) Efc_of_Perceived_Lead_Time_on_Attract(109)

Efc_of_Price_on_Attract(96)

AFFX: Analog_Indicated_Share_of_Orders(91) Total_Attractiveness(101)

UNITS: dimensionless

93: $\text{Comp_Attract} =$

$(\text{Efc_of_Defects_on_Comp_Attract} * \text{Efc_of_Lead_Time_on_Comp_Attract} * \text{Efc_of_Price_on_Comp_Attract} * \text{Efc_of_OTD_on_Comp_Attract})$

DEFN: Attractiveness of the Competitor's Products

USES: Efc_of_Defects_on_Comp_Attract(105) Efc_of_Lead_Time_on_Comp_Attract(106)
 Efc_of_OTD_on_Comp_Attract(108) Efc_of_Price_on_Comp_Attract(94)
 AFFX: Competitor_Share(92) Total_Attractiveness(101)
 UNITS: dimensionless

Analog primarily manufactures integrated circuits which are then used by other manufacturers in the assembly of larger products. As a result, of all the quality related measures, the number of outgoing defects is assumed to have the largest effect on market share. An additional defect in an Analog product is likely to be very costly to the customer as they may have to replace the entire item in which the Analog product resides. Product lead time is assumed to be the next most important determinant of market share, and on-time delivery percentage is assumed to be the least important.

The function relating defects to attractiveness is strictly decreasing with a second derivative that is initially positive, but becomes negative at approximately the mid-point as defects fall. As the defect level approaches zero the contribution to total attractiveness approaches 1.5. An identical function is used for the competitor.

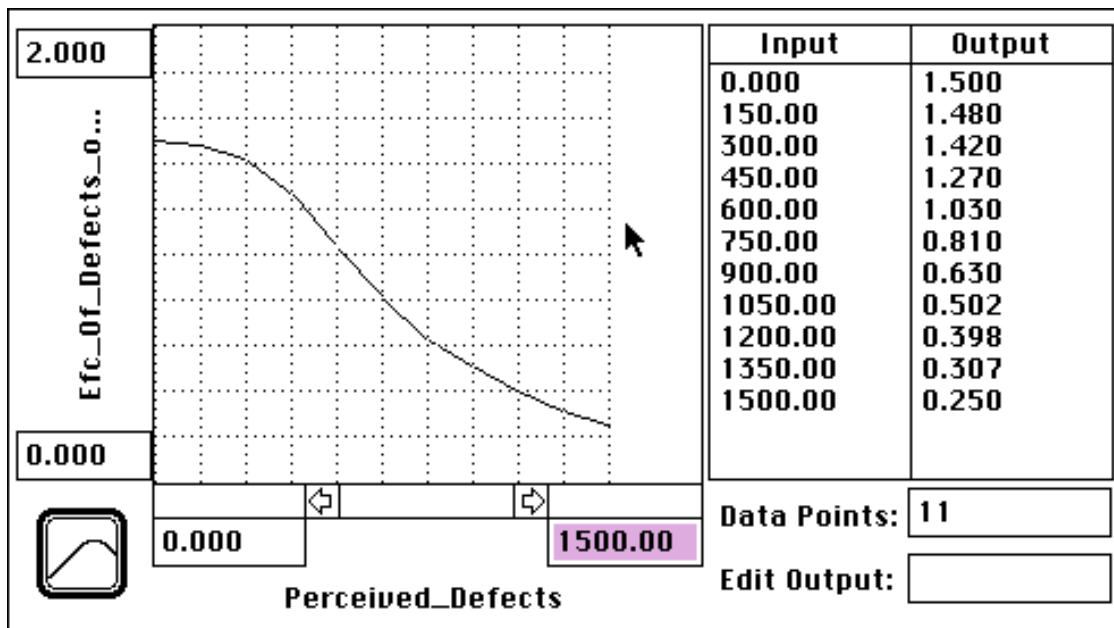

104: Efc_Of_Defects_on_Attract = GRAPH(Perceived_Defects)
 DATA: (0.00, 1.50), (150, 1.48), (300, 1.42), (450, 1.27), (600, 1.03), (750, 0.81), (900, 0.63), (1050, 0.502), (1200, 0.398), (1350, 0.307), (1500, 0.25)

DEFN: The Effect of Outgoing Defects on Product Attractiveness

USES: Perceived_Defects(85)
 AFFX: Product_Attractiveness(97)
 UNITS: dimensionless

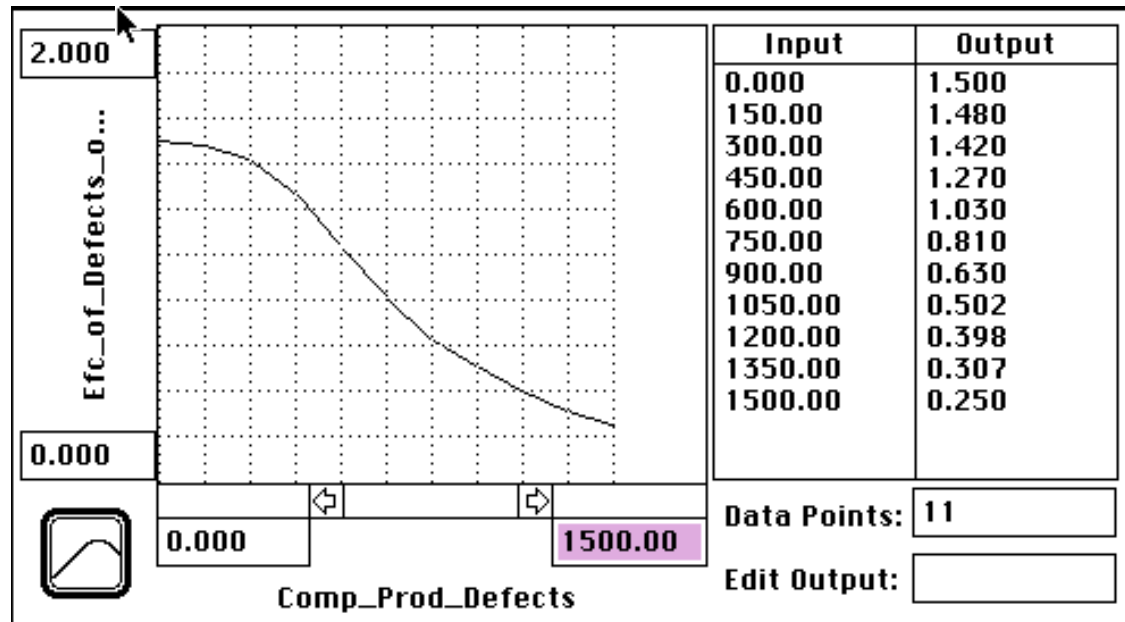

105: Efc_of_Defects_on_Comp_Attract = GRAPH(Comp_Prod_Defects)
 DATA: (0.00, 1.50), (150, 1.48), (300, 1.42), (450, 1.27), (600, 1.03), (750, 0.81), (900, 0.63), (1050, 0.502), (1200, 0.398), (1350, 0.307), (1500, 0.25)

DEFN: The Effect of Outgoing Defects on the Competitor's Product Attractiveness
 USES: Comp_Prod_Defects(571)
 AFFX: Comp_Attract(93)
 UNITS: dimensionless

The relevant interval for lead-time is assumed to be between one and five months. The function relating lead-time and the attractiveness resulting from lead-time is defined over the interval .75 to 1.25. It is everywhere decreasing with a second derivative that is initially positive and becomes negative at approximately the mid-point. An identical function is used for the competitor.

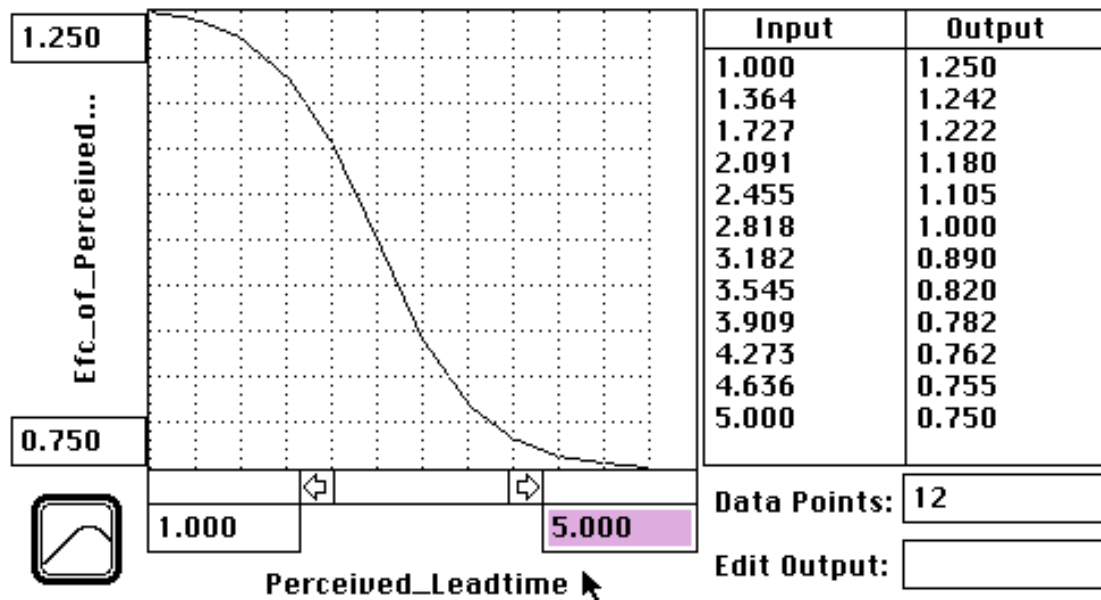

109: Efc_of_Perceived_Lead_Time_on_Attract = GRAPH(Perceived_Leadtime)
 DATA: (1.00, 1.25), (1.36, 1.24), (1.73, 1.22), (2.09, 1.18), (2.45, 1.10), (2.82, 1.00), (3.18, 0.89), (3.55, 0.82), (3.91, 0.782), (4.27, 0.762), (4.64, 0.755), (5.00, 0.75)

DEFN: The Effect of Perceived Leadtime on Product Attractiveness
 USES: Perceived_Leadtime(87)
 AFFX: Product_Attractiveness(97)
 UNITS: dimensionless

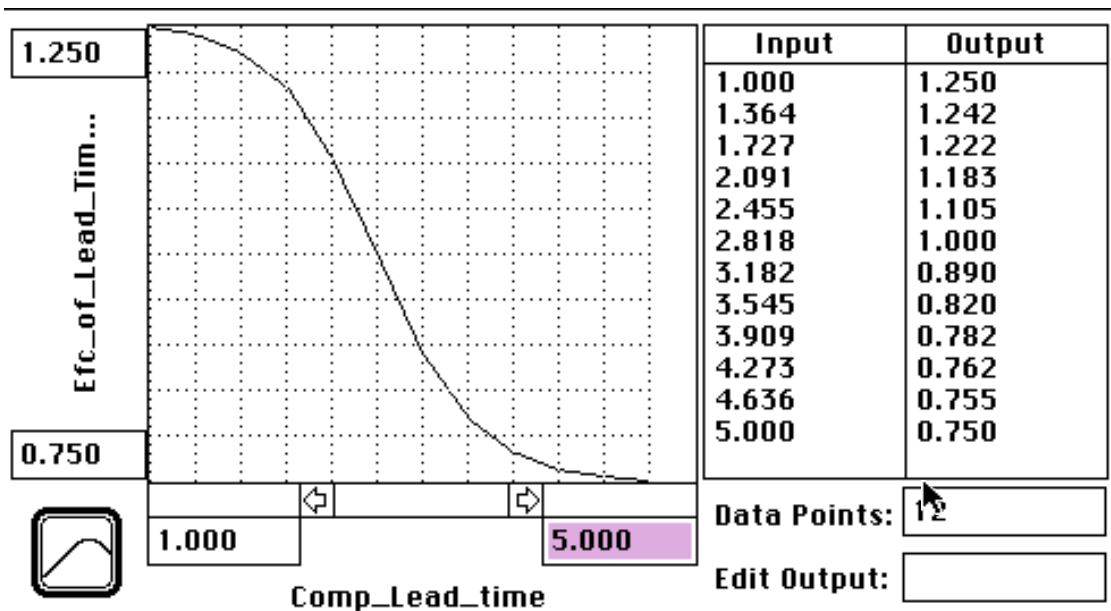

106: Efc_of_Lead_Time_on_Comp_Attract = GRAPH(Comp_Lead_time)
 DATA: (1.00, 1.25), (1.36, 1.24), (1.73, 1.22), (2.09, 1.18), (2.45, 1.10), (2.82, 1.00), (3.18, 0.89), (3.55, 0.82), (3.91, 0.782), (4.27, 0.762), (4.64, 0.755), (5.00, 0.75)

DEFN: Effect of Leadtime on the Competitor's Product Attractiveness
 USES: Comp_Lead_time(565)
 AFFX: Comp_Attract(93)
 UNITS: dimensionless

The on-time delivery percentage is defined over the interval from zero to one. The function relating OTD and attractiveness is assumed to be increasing with a second derivative that is initially positive but becomes negative. The function is defined over the range of zero to 1.2 so that a very poor performance on on-time delivery can overwhelm excellent performances in other areas. An identical function is used for the competitor.

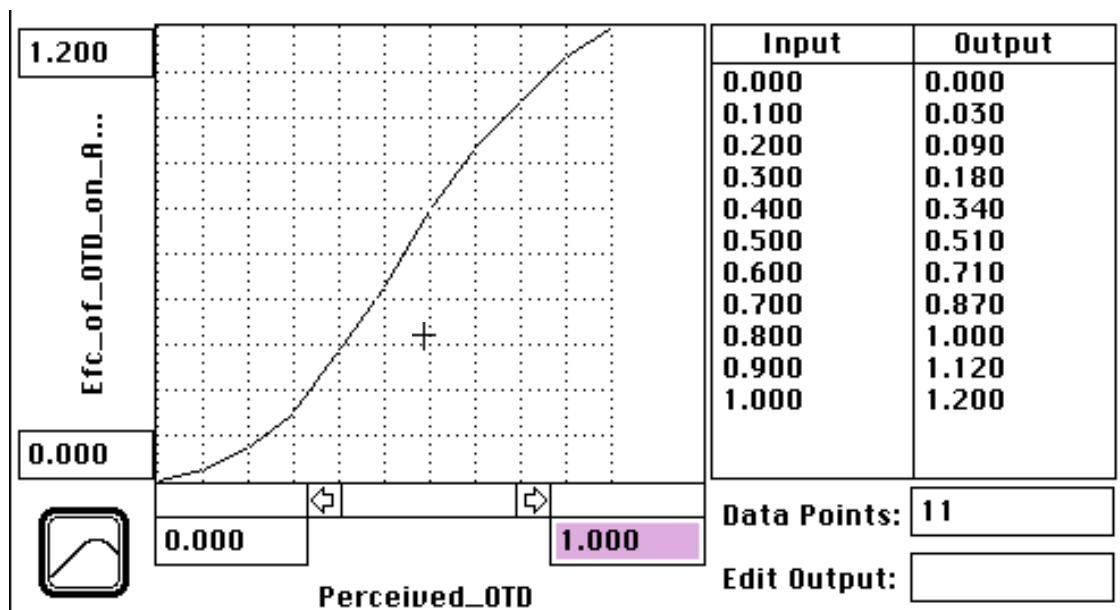

107: Efc_of_OTD_on_Attract = GRAPH(Perceived_OTD)
 DATA: (0.00, 0.00), (0.1, 0.03), (0.2, 0.09), (0.3, 0.18), (0.4, 0.34), (0.5, 0.51), (0.6, 0.71), (0.7, 0.87), (0.8, 1.00), (0.9, 1.12), (1, 1.20)

DEFN: Effect of On-Time Delivery on Product Attractiveness
 USES: Perceived_OTD(89)
 AFFX: Product_Attractiveness(97)
 UNITS: dimensionless

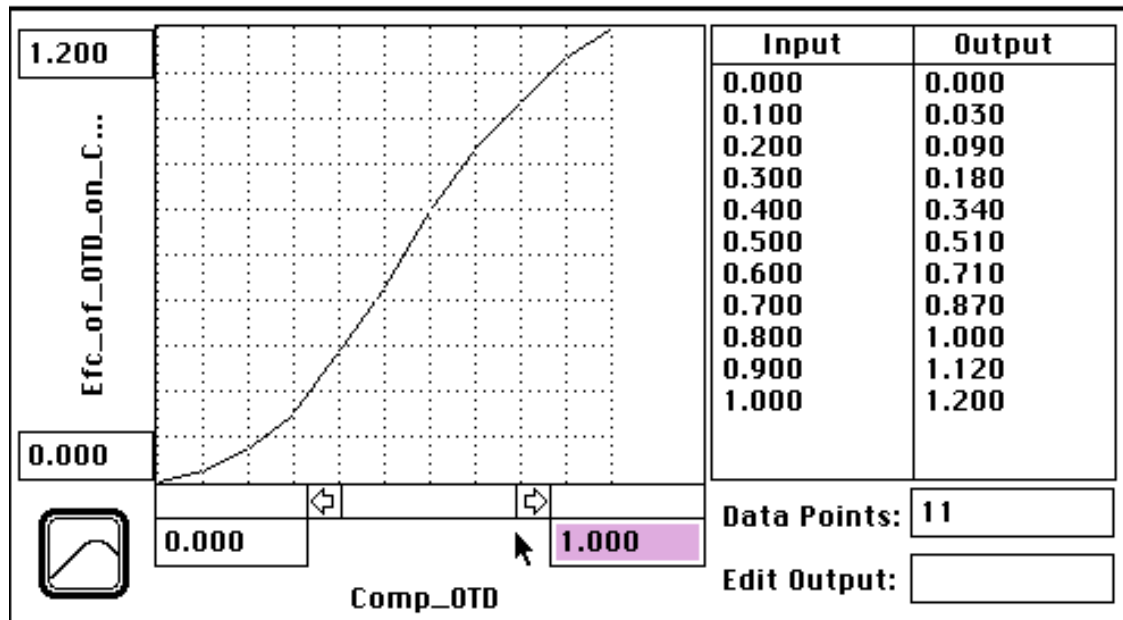

108: Efc_of_OTD_on_Comp_Attract = GRAPH(Comp_OTD)

DATA: (0.00, 0.00), (0.1, 0.03), (0.2, 0.09), (0.3, 0.18), (0.4, 0.34), (0.5, 0.51), (0.6, 0.71), (0.7, 0.87), (0.8, 1.00), (0.9, 1.12), (1.00, 1.20)

DEFN: Effect of On-Time Delivery on the Competitor's Product Attractiveness

USES: Comp_OTD(567)

AFFX: Comp_Attract(93)

UNITS: dimensionless

Analog's current market share is also assumed to affect the total attractiveness of their products. Analog had a dominant share in many of its markets, and, as a result many customers, in an effort to minimize their dependence on a single supplier, limited the number of orders given to Analog to a fixed fraction of their total purchases [Kaplan 1990b]. The function used to represent this effect is decreasing with a second derivative that is initially positive and becomes negative at the midpoint. The output value of one, no effect of share, occurs when Analog's share is fifty percent. As share rises above 50% the attractiveness of Analog's products diminishes rapidly. If share falls below fifty percent, attractiveness rises slightly.

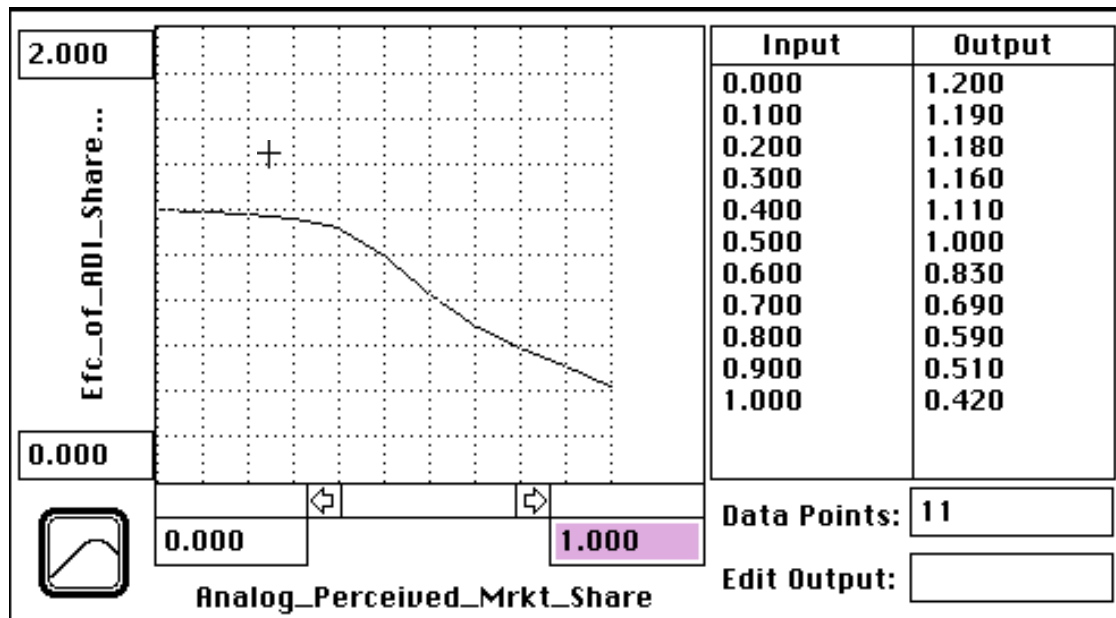

103: Efc_of_Analog_Share_on_Attract = GRAPH(Analog_Perceived_Mrkt_Share)
 DATA: (0.00, 1.20), (0.1, 1.19), (0.2, 1.18), (0.3, 1.16), (0.4, 1.11), (0.5, 1.00), (0.6, 0.83), (0.7, 0.69), (0.8, 0.59), (0.9, 0.51), (1, 0.42)

DEFN: Effect of Analog's Perceived Market Share on Product Attractiveness
 USES: Analog_Perceived_Mrkt_Share(83)
 AFFX: Product_Attractiveness(97)
 UNITS: dimensionless

The final determinant of the attractiveness of Analog's products is price. The effect of price on attractiveness is calculated by raising price to a negative power. This results in the traditional downward sloping relationship between price and quantity demanded. The sensitivity parameter, the exponent, is assumed to be three. At Analog's normal market share of 50% this yields a price elasticity of demand that is approximately equal to negative one.

96: Eff_of_Price_on_Attract = Price^(-Sensitivity_to_Price)

DEFN: Effect of Price on Product Attractiveness
 USES: Price(413) Sensitivity_to_Price(98)
 AFFX: Product_Attractiveness(97)
 UNITS: dimensionless

94: Efc_of_Price_on_Comp_Attract = Comp_Price^(-Sensitivity_to_Price)

DEFN: Effect of Price on the Competitor's Product Attractiveness
 USES: Comp_Price(569) Sensitivity_to_Price(98)
 AFFX: Comp_Attract(93)
 UNITS: dimensionless

98: Sensivity_to_Price = 3

DEFN: Sensivity of Product Attractiveness to Price
 AFFX: Efc_of_Price_on_Comp_Attract(94) Eff_of_Price_on_Attract(96)
 UNITS: dimensionless

2.2.2 Customer Perceptions

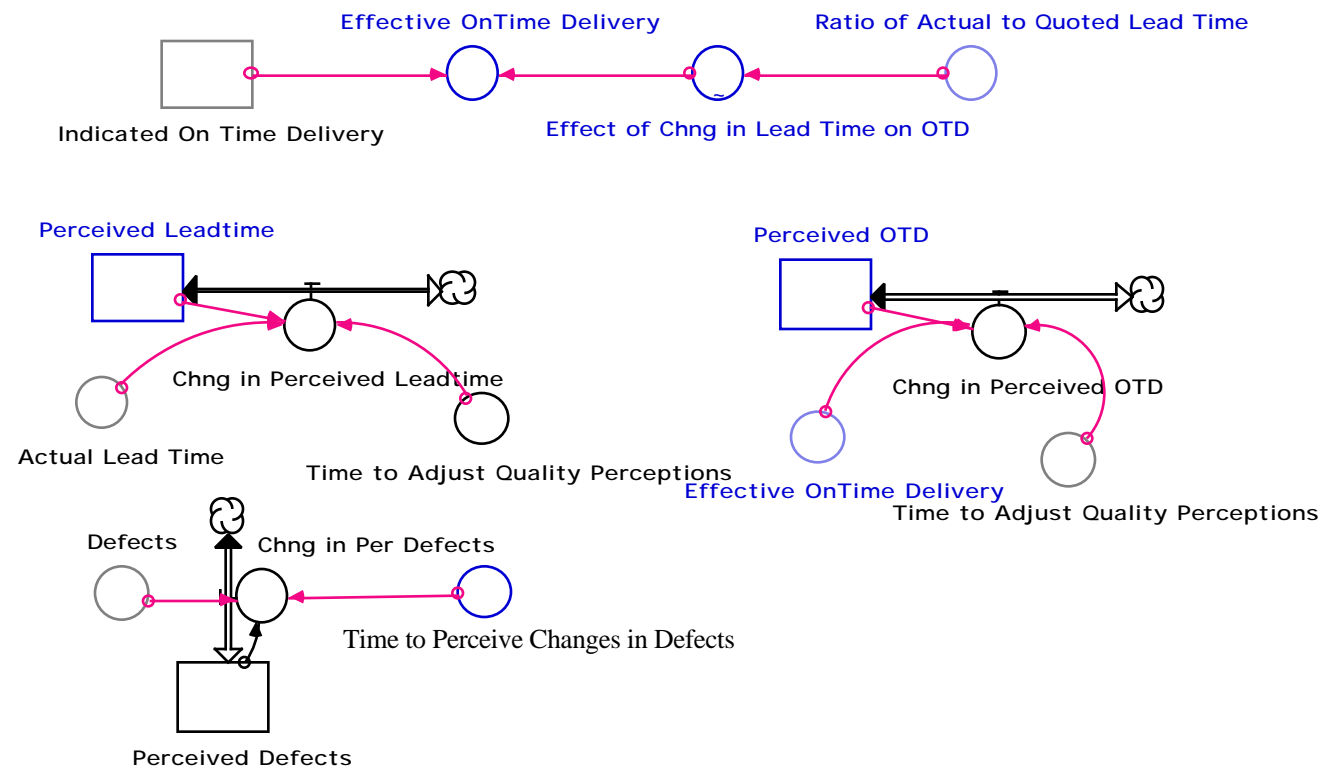

Since information regarding market share is uncertain and is only calculated periodically, Analog's customers are assumed to perceive changes in Analog's market share with a delay. This is modeled as a first order exponentially weighted averaging process with a time constant of six months. The time constant was selected based upon the author's judgment.

83: Analog_Perceived_Mrkt_Share = Analog_Perceived_Mrkt_Share *(t-dt) + (Chng_in_Per_Share) * dt
 INIT: .45

DEFN: Analog's Perceived Market Share
 USES: Chng_in_Per_Share(84)
 AFFX: Chng_in_Per_Share(84) Efc_of_Analog_Share_on_Attract(103)
 UNITS: share points

84: $\text{Chng_in_Per_Share} = (\text{Analog_Indicated_Share_of_Orders} - \text{Analog_Perceived_Mrkt_Share}) / \text{Trad_Formation_Time}$

DEFN: The Change in Analog's Perceived Market Share
 USES: Analog_Indicated_Share_of_Orders(91) Analog_Perceived_Mrkt_Share(83)
 Trad_Formation_Time(102)
 AFFX: Analog_Perceived_Mrkt_Share(83)
 UNITS: share points/month

102: Trad_Formation_Time = 6

DEFN: Time Required to Adjust Perceived Market Share
 AFFX: Chng_in_Per_Share(84)
 UNITS: months

Analog's customers are also assumed to perceive changes in Analog's product and service quality with a delay. The structures used to represent the formation of perceptions are identical for product defects and lead-time. The perception process is represented by a first order exponentially weighted average of the actual performance measure. The time constant for the adjustment process is assumed to be twelve months for defects, and three months for lead-time. A longer time constant is used for defects based upon the assumption that changes in lead-time and on-time delivery are recognized quickly because the only significant delay is in reporting, while product defects may not be recognized until the product has been inspected and, possibly, used long enough for the defect to become apparent.

85: $\text{Perceived_Defects} = \text{Perceived_Defects} * (t-dt) + (\text{Chng_in_Per_Defects}) * dt$
 INIT: Defects

DEFN: Perceived Outgoing Products Defects
 USES: Chng_in_Per_Defects(86) Defects(231)
 AFFX: Chng_in_Per_Defects(86) Efc_Of_Defects_on_Attract(104) Comp_Prod_Defects(571)
 Competitor_Defect_Target(580)
 UNITS: defects/million units shipped

86: $\text{Chng_in_Per_Defects} = (\text{Defects} - \text{Perceived_Defects}) / \text{Time_to_Perceive_Changes_in_Avg_Defects}$

DEFN: Change in Perceived Outgoing Product Defects
 USES: Defects(231) Perceived_Defects(85) Time_to_Perceive_Changes_in_Avg_Defects(100)
 AFFX: Perceived_Defects(85)
 UNITS: defects/million units shipped/month

100: Time_to_Perceive_Changes_in_Avg_Defects = 12

DEFN: Average Time Required to Adjust the Perceived Level of Outgoing Product Defects
 AFFX: Chng_in_Per_Defects(86)
 UNITS: months

87: $\text{Perceived_Leadtime} = \text{Perceived_Leadtime} * (t-dt) + (- \text{Chng_in_Perceived_Leadtime}) * dt$
 INIT: Initial_Lead_Time

DEFN: Perceived Product Leadtime

USES: Chng_in_Perceived_Leadtime(88) Initial_Lead_Time(655)

AFFX: Chng_in_Perceived_Leadtime(88) Efc_of_Perceived_Lead_Time_on_Attract(109)

Competitor_Lead_Time_Target(581)

UNITS: months

88: $\text{Chng_in_Perceived_Leadtime} = (\text{Perceived_Leadtime} - \text{Actual_Lead_Time}) / \text{Time_to_Adjust_Quality_Perceptions}$

DEFN: Change in the Perceived Product Leadtime

USES: Actual_Lead_Time(120) Perceived_Leadtime(87) Time_to_Adjust_Quality_Perceptions(99)

AFFX: Perceived_Leadtime(87)

UNITS: months/month

655: Initial_Lead_Time = 4

DEFN: Inital Condition for Product Leadtime

AFFX: Perceived_Leadtime(87) Comp_Lead_time(565) Initial_Industry_Lead_Time(594)

UNITS: months

99: Time_to_Adjust_Quality_Perceptions = 3

DEFN: Average Time Required to Adjust Perceptions of Quality Measures

AFFX: Chng_in_Perceived_Leadtime(88) Chng_in_Perceived_OTD(90)

UNITS: months

The perceived on-time delivery percentage is calculated in an identical manner to perceived defects and lead-time.

89: $\text{Perceived_OTD} = \text{Perceived_OTD} * (t-dt) + (- \text{Chng_in_Perceived_OTD}) * dt$
 INIT: Actual_OTD

DEFN: Perceived On-Time Delivery Percentage

USES: Actual_OTD(678) Chng_in_Perceived_OTD(90)

AFFX: Chng_in_Perceived_OTD(90) Efc_of_OTD_on_Attract(107) Competitor_OTD_Target(582)

UNITS: dimensionless

90: $\text{Chng_in_Perceived_OTD} = (\text{Perceived_OTD} - \text{Effective_OnTime_Delivery}) / \text{Time_to_Adjust_Quality_Perceptions}$

DEFN: Change in the Perceived On-Time Delivery Percentage

USES: Effective_OnTime_Delivery(95) Perceived_OTD(89) Time_to_Adjust_Quality_Perceptions(99)

AFFX: Perceived_OTD(89)

UNITS: 1/months

The formulation for perceived on-time delivery also has an additional complication. Rather than use as its input the indicated on time delivery percentage calculated in the improvement sector (#4), the process uses the effective on-time delivery percentage. The indicated on-time delivery percentage represents the maximum capability of the organization. This capability will not be achieved, however, if lead-times are incorrectly quoted. As a result the effective on-time delivery

percentage is equal to the indicated on-time delivery percentage multiplied by an index that adjusts for the difference between actual and quoted lead-times.

95: Effective_OnTime_Delivery =
 Indicated_On_Time_Delivery*Effect_of_Chng_in_Lead_Time_on_OTD

DEFN: Effective On-Time Delivery Percentage
 USES: Effect_of_Chng_in_Lead_Time_on_OTD(110) Indicated_On_Time_Delivery(210)
 AFFX: Chng_in_Perceived_OTD(90)
 UNITS: 1/months

As the ratio of actual to quoted lead-times increases beyond one, the effective on-time delivery percentage is reduced by a decreasing function with a positive second derivative. If the actual lead-times are more than twice the quoted lead-times the on-time delivery percentage is reduced by more than 20%.

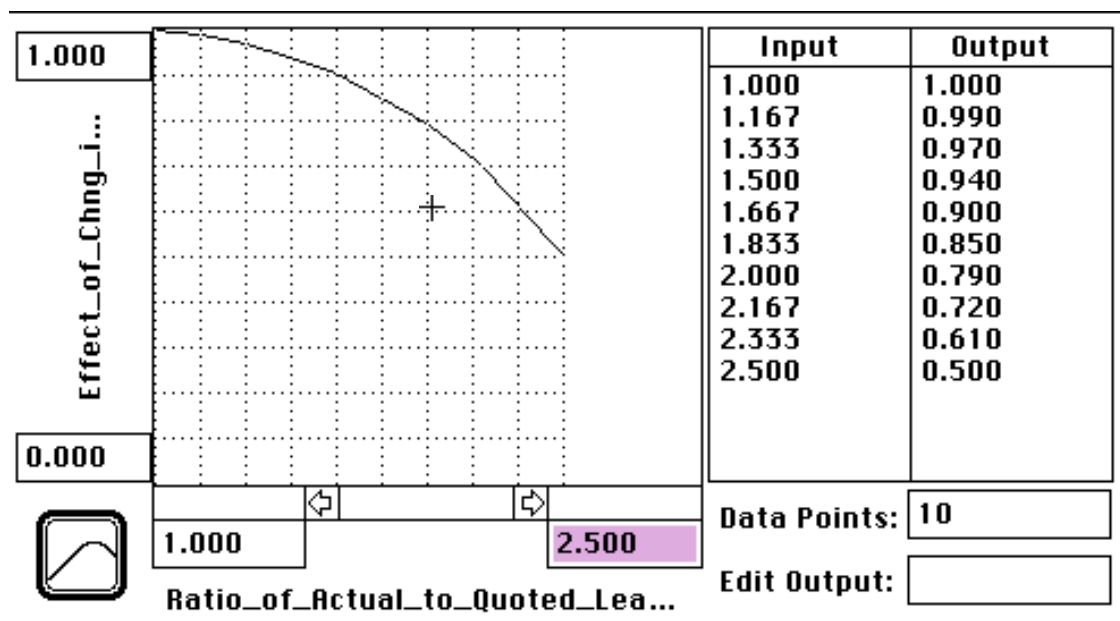

110: Effect_of_Chng_in_Lead_Time_on_OTD = GRAPH(Ratio_of_Actual_to_Quoted_Lead_Time)
 DATA: (1.00, 1.00), (1.17, 0.99), (1.33, 0.97), (1.50, 0.94), (1.67, 0.9), (1.83, 0.85), (2.00, 0.79), (2.17, 0.72), (2.33, 0.61), (2.50, 0.5)

DEFN: Effect of Changes in Lead Time on On-Time Delivery
 USES: Ratio_of_Actual_to_Quoted_Lead_Time(125)
 AFFX: Effective_OnTime_Delivery(95)
 UNITS: dimensionless

2.3 Unit Sales

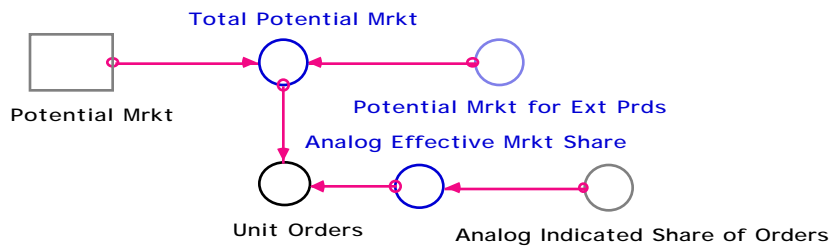

The final sub-section in the market sector determines the number of units sold based upon the potential market and the indicated market share. The monthly unit sales is the product of the total potential market and Analog's effective market share. Analog's effective share of the market is assumed to be an exponentially weighted average of the indicated market share. This delay represents the effect of long-term contracts and design lock in. Customers who enter into long term purchase agreements or design a particular product using an Analog product as an important component can not instantly adjust to changes in product quality as they must wait for the agreement to expire or re-design the given product. The total potential market is the sum of the potential market for breakthrough products and the potential market for line extension products.

$$113: \text{Unit_Orders} = \text{Total_Potential_Mrkt} * \text{Analog_Effective_Mrkt_Share}$$

DEFN: Analog's Unit Orders

USES: Analog_Effective_Mrkt_Share(111) Total_Potential_Mrkt(112)

AFFX: Orders(115) New_CQLT(118) Chng_in_Forecast_Orders(131) Order_Trend(135)

Indicated_Overhead(348) Unit_Sales_In(632)

UNITS: units sales/month

$$111: \text{Analog_Effective_Mrkt_Share} = \text{SMTH1}(\text{Analog_Indicated_Share_of_Orders}, 6)$$

DEFN: Analog's Effective Market Share

USES: Analog_Indicated_Share_of_Orders(91)

AFFX: Unit_Orders(113)

UNITS: share points

$$112: \text{Total_Potential_Mrkt} = \text{Potential_Mrkt} + \text{Potential_Mrkt_for_Ext_Prds}$$

DEFN: Total Potential Market for Analog's Products

USES: Potential_Mrkt(68) Potential_Mrkt_for_Ext_Prds(82)

AFFX: Unit_Orders(113)

UNITS: units sales/month

3. Manufacturing

3.0 Overview

This sector represents that core manufacturing process. It takes as its major inputs unit orders from the market sector and yield and cycle time from the improvement sector. It also determines capital, labor and material requirements. Many of formulations used here draw upon established system dynamics models of production and inventory found in Forrester [1961] Mass [1975] and Lyneis[1980].

3.1 Backlog and Quoted Leadtimes

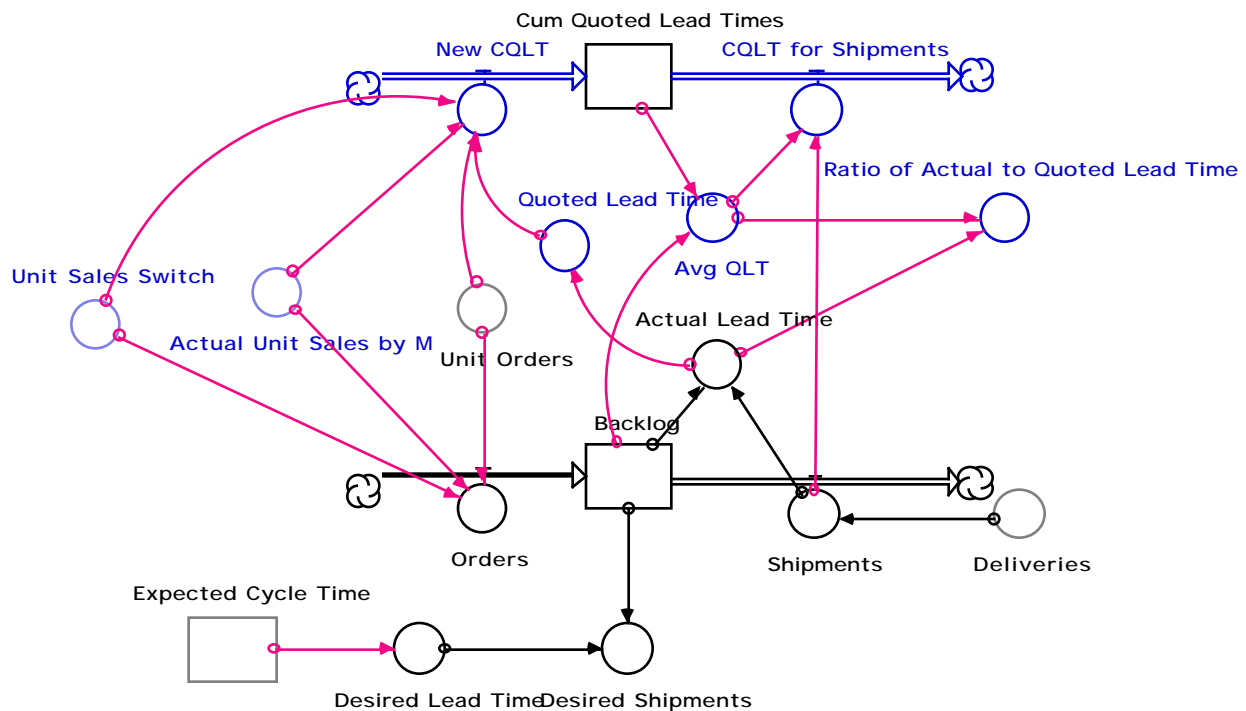

Following the standard formulation, the order backlog is increased by sales and decreased by shipments. Shipments are equal to deliveries which will be discussed subsequently. The desired lead-time is assumed to be equal to the expected cycle time based upon the assumption of a make to order production system. The desired shipment rate is equal to the backlog divided by the desired product lead-time. The actual average lead-time is calculated as the backlog divided by the actual shipment rate.

$$114: \text{Backlog} = \text{Backlog} * (t-dt) + (\text{Orders} - \text{Shipments}) * dt$$

INIT: $\text{Desired_Lead_Time} * \text{Actual_Unit_Sales_by_M}$

DEFN: Order Backlog

USES: $\text{Actual_Unit_Sales_by_M}(649)$ $\text{Desired_Lead_Time}(122)$ $\text{Orders}(115)$ $\text{Shipments}(116)$

AFFX: $\text{Cum_Quoted_Lead_Times}(117)$ $\text{Actual_Lead_Time}(120)$ $\text{Avg_QLT}(121)$

$\text{Desired_Shipments}(123)$ $\text{Cum_Price_in_Backlog}(408)$ $\text{Per_Unit_Price_for_Units_in_Backlog}(420)$

UNITS: units

115: $\text{Orders} = \text{Unit_Orders} * (1 - \text{Unit_Sales_Switch}) + \text{Actual_Unit_Sales_by_M} * \text{Unit_Sales_Switch}$

DEFN: Orders

USES: $\text{Actual_Unit_Sales_by_M}(649)$ $\text{Unit_Orders}(113)$ $\text{Unit_Sales_Switch}(667)$

AFFX: $\text{Backlog}(114)$ $\text{Incr_in_Cum_Price}(409)$

UNITS: units/month

116: $\text{Shipments} = \text{Deliveries}$

DEFN: Shipments

USES: $\text{Deliveries}(150)$

AFFX: $\text{Backlog}(114)$ $\text{CQLT_for_Shipments}(119)$ $\text{Actual_Lead_Time}(120)$ $\text{Decr_in_Cum_Price}(410)$

UNITS: units/month

122: $\text{Desired_Lead_Time} = \text{Expected_Cycle_Time}$

DEFN: Desired Leadtime

USES: $\text{Expected_Cycle_Time}(126)$

AFFX: $\text{Backlog}(114)$ $\text{Desired_Shipments}(123)$

UNITS: months

120: $\text{Actual_Lead_Time} = \text{Backlog} / \text{Shipments}$

DEFN: Average Actual Leadtime

USES: $\text{Backlog}(114)$ $\text{Shipments}(116)$

AFFX: $\text{Chng_in_Perceived_Leadtime}(88)$ $\text{Quoted_Lead_Time}(124)$

$\text{Ratio_of_Actual_to_Quoted_Lead_Time}(125)$

UNITS: months

123: $\text{Desired_Shipments} = \text{Backlog} / \text{Desired_Lead_Time}$

DEFN: Desired Shipments

USES: $\text{Backlog}(114)$ $\text{Desired_Lead_Time}(122)$

AFFX: $\text{Deliveries}(150)$ $\text{Desired_Wafers_from_WIP}(158)$ $\text{Desired_Capacity_per_Cycle}(173)$

$\text{Desired_Cap_per_Month}(175)$

UNITS: units/month

At the time of each order a lead-time for that order is quoted. The quoted lead-time is assumed to be equal to the current measured lead-time.

124: $\text{Quoted_Lead_Time} = \text{Actual_Lead_Time}$

DEFN: Current Quote for Product Leadtime

USES: $\text{Actual_Lead_Time}(120)$

AFFX: $\text{Cum_Quoted_Lead_Times}(117)$ $\text{New_CQLT}(118)$

UNITS: months

The level Cumulative Quoted Lead-time is increased by amount equal to the current lead-time quote each time a sale is made. It is decreased by the average quoted lead-time for units in the backlog each time an order is shipped. The average quoted lead-time for units in the backlog is calculated by dividing the level of cumulative quoted lead-times by the current backlog. Finally, for the purpose of determining effective on-time delivery the ratio of actual to quoted lead-times is calculated.

117: $Cum_Quoted_Lead_Times = Cum_Quoted_Lead_Times * (t-dt) + (New_CQLT - CQLT_for_Shipments) * dt$
 INIT: Backlog*Quoted_Lead_Time

DEFN: Cumulative Quoted Leadtimes
 USES: Backlog(114) CQLT_for_Shipments(119) New_CQLT(118) Quoted_Lead_Time(124)
 AFFX: Avg_QLT(121)
 UNITS: months

118: $New_CQLT = ((1 - Unit_Sales_Switch) * Unit_Orders + (Unit_Sales_Switch * Actual_Unit_Sales_by_M)) * Quoted_Lead_Time$

DEFN: Increase in the Cumulative Quoted Leadtimes
 USES: Actual_Unit_Sales_by_M(649) Quoted_Lead_Time(124) Unit_Orders(113)
 Unit_Sales_Switch(667)
 AFFX: Cum_Quoted_Lead_Times(117)
 UNITS: months/month

119: $CQLT_for_Shipments = Avg_QLT * Shipments$

DEFN: Decrease in Cumulative Quoted Leadtimes due to Shipments
 USES: Avg_QLT(121) Shipments(116)
 AFFX: Cum_Quoted_Lead_Times(117)
 UNITS: months/month

121: $Avg_QLT = Cum_Quoted_Lead_Times / Backlog$

DEFN: Average Quoted Leadtime for Units in the Backlog
 USES: Backlog(114) Cum_Quoted_Lead_Times(117)
 AFFX: CQLT_for_Shipments(119) Ratio_of_Actual_to_Quoted_Lead_Time(125)
 UNITS: months/unit

125: $Ratio_of_Actual_to_Quoted_Lead_Time = Actual_Lead_Time / Avg_QLT$

DEFN: Ratio of the Current Actual to the Current Quoted Leadtime
 USES: Actual_Lead_Time(120) Avg_QLT(121)
 AFFX: Effect_of_Chng_in_Lead_Time_on_OTD(110)
 UNITS: dimensionless

3.2 Forecasting Sales, Cycle Time, and Yield

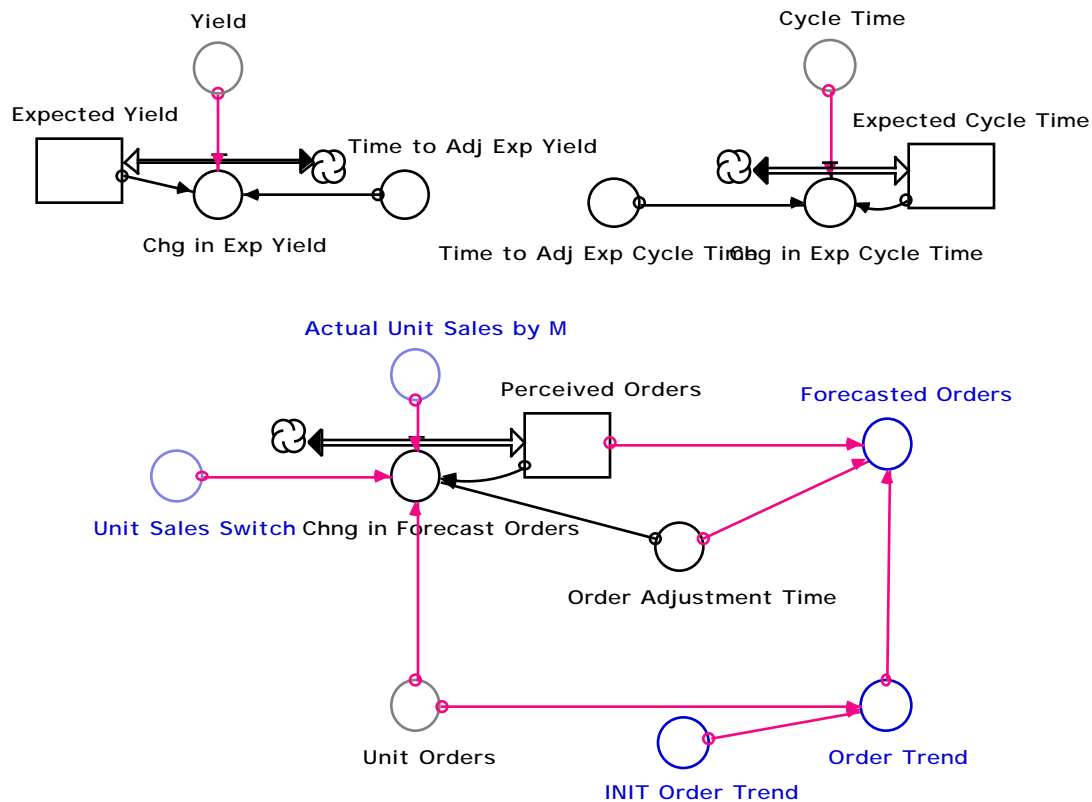

The materials planning and scheduling function requires three pieces of information: the forecasted order rate, the expected wafer yield, and the expected manufacturing cycle time. Expectations concerning yield and cycle time are assumed to be formed adaptively. Expected yield and cycle time are determined by exponentially weighted averages of their respective historical values. The time constants are assumed to be six months for both processes based upon interview data and the authors' judgment [Schneiderman 1992, Kaplan 1990a].

126: $\text{Expected_Cycle_Time} = \text{Expected_Cycle_Time} * (t-dt) + (\text{Chg_in_Exp_Cycle_Time}) * dt$
 INIT: Actual_Cycle_Time

DEFN: Expected Manufacturing Cycle Time
 USES: Actual_Cycle_Time(671) Chg_in_Exp_Cycle_Time(127)
 AFFX: Desired_Lead_Time(122) Chg_in_Exp_Cycle_Time(127) Desired_WIP(159)
 Desired_Capacity_per_Cycle(173)
 UNITS: months

127: $\text{Chg_in_Exp_Cycle_Time} = (\text{Cycle_Time} - \text{Expected_Cycle_Time}) / \text{Time_to_Adj_Exp_Cycle_Time}$

DEFN: Change in the Expected Manufacturing Cycle Time
 USES: Cycle_Time(228) Expected_Cycle_Time(126) Time_to_Adj_Exp_Cycle_Time(136)
 AFFX: Expected_Cycle_Time(126)
 UNITS: months/month

136: Time_to_Adj_Exp_Cycle_Time = 6

DEFN: Average Time Required to Change the Expected Manufacturing Cycle Time
 AFFX: Chg_in_Exp_Cycle_Time(127)
 UNITS: months

128: Expected_Yield = Expected_Yield *(t-dt) + (Chg_in_Exp_Yield) * dt
 INIT: Actual_Yield

DEFN: Expected Manufacturing Yield
 USES: Actual_Yield(687) Chg_in_Exp_Yield(129)
 AFFX: Chg_in_Exp_Yield(129) Desired_Material_Inventory(142) Mtrl_Forecast(146) Desired_Starts(157)
 Desired_WIP(159) Desired_Capacity_per_Cycle(173) Desired_Cap_per_Month(175)
 UNITS: dimensionless

129: Chg_in_Exp_Yield = (Yield-Expected_Yield)/Time_to_Adj_Exp_Yield

DEFN: Change in the Expected Manufacturing Yield
 USES: Expected_Yield(128) Time_to_Adj_Exp_Yield(137) Yield(265)
 AFFX: Expected_Yield(128)
 UNITS: 1/months

137: Time_to_Adj_Exp_Yield = 6

DEFN: Average Time Required to Adjust Expected Manufacturing Yield
 AFFX: Chg_in_Exp_Yield(129)
 UNITS: months

Expectations concerning the order rate are formed extrapolatively. The order forecast is determined using the TREND function discussed in Sterman [1987, 1988]. The perceived order rate is first calculated using the standard first order exponentially weighted moving average. The time constant is assumed to be three months based upon a quarterly evaluation and budgeting cycle. The exponential growth trend, using twelve month horizon, is also calculated based upon the unit order rate.

130: Perceived_Orders = Perceived_Orders *(t-dt) + (Chng_Perceived_Orders) * dt
 INIT: Actual_Unit_Sales_by_M/(1+Order_Trend*Order_Adjustment_Time)

DEFN: Perceived Rate of Orders
 USES: Actual_Unit_Sales_by_M(649) Chng_in_Perceived_Orders(131) Order_Adjustment_Time(134)
 Order_Trend(135)
 AFFX: Chng_in_Forecast_Orders(131) Forecasted_Orders(132)
 UNITS: orders/month

131: Chng_in_Perceived_Orders = (((1-
 Unit_Sales_Switch)*(Unit_Orders)+(Actual_Unit_sales_by_M*Unit_Sales_Switch))-
 Perceived_Orders)/Order_Adjustment_Time

DEFN: Change in the Perceived Rate of Orders

USES: Actual_Unit_Sales_by_M(649) Order_Adjustment_Time(134) Perceived_Orders(130)
Unit_Orders(113) Unit_Sales_Switch(667)

AFFX: Perceived_Orders(130)

UNITS: orders/month/month

134: Order_Adjustment_Time = 3

DEFN: Average Time Required to Adjust the Perceived Rate of Orders

AFFX: Perceived_Orders(130) Chng_in_Forecast_Orders(131) Forecasted_Orders(132)

UNITS: months

135: Order_Trend = TREND(Unit_Orders,12,INIT_Order_Trend)

DEFN: Growth Trend in Order

USES: INIT_Order_Trend(133) Unit_Orders(113)

AFFX: Perceived_Orders(130) Forecasted_Orders(132)

UNITS: 1/months

133: INIT_Order_Trend = 0.005

DEFN: Intital Condition for Order Trend

AFFX: Order_Trend(135)

UNITS: 1/months

The order forecast is then calculated by multiplying the perceived order rate by one plus the growth trend multiplied by the time constant used to determine the perceived order rate. Sterman [1987] shows that this procedure produces an unbiased forecast and has been shown to produce forecasts that match closely with human behavior. The TREND function used here is described in the iThink software users guide [Richmond 1992].

132: Forecasted_Orders = Perceived_Orders*(1+Order_Trend*Order_Adjustment_Time)

DEFN: Forecasted Rate of Orders

USES: Order_Adjustment_Time(134) Order_Trend(135) Perceived_Orders(130)

AFFX: Desired_Material_Inventory(142) Mtrl_Forecast(146) Desired_FG_Inventory(155)

Desired_Starts(157) Desired_WIP(159)

UNITS: orders/month

3.3 Materials Acquisition and Inventory

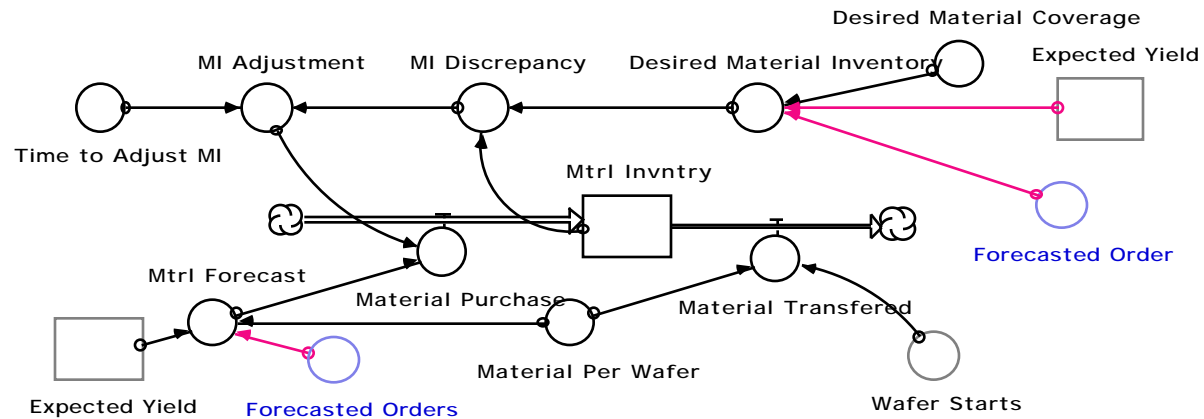

The next element of the manufacturing sector determines the level of the material inventory. Materials inventory is increased by purchases and decreased by the transfer of materials to the manufacturing process. Monthly materials purchases are equal to the materials forecast plus an adjustment to maintain the desired level of materials inventory. The materials forecast is equal to the forecasted order rate multiplied by the number of material units required per wafer divided by the expected manufacturing yield. The adjustment for inventory maintenance is equal to the discrepancy between the desired and actual inventory levels divided by the time required to adjust material inventory, here assumed to be three months based upon the assumed quarterly planning cycle. The desired materials inventory is equal to the forecasted order rate, divided by the expected manufacturing yield, multiplied by the desired inventory coverage, measured in number of months sales in inventory. The desired coverage is set to eight months of sales based upon estimates taken from Analog annual reports [Analog Devices 1985, 1986, 1987, 1988, 1989, 1990].

138: $Mtrl_Invntry = Mtrl_Invntry * (t-dt) + (Material_Purchase - Material_Transferred) * dt$
 INIT: Actual_Value_of_Mtrl_Inventory/Cost_per_Material_Unit

DEFN: Materials Inventory
 USES: Actual_Value_of_Mtrl_Inventory(685) Cost_per_Material_Unit(336) Material_Purchase(139)
 Material_Transferred(140)
 AFFX: MI_Discrepancy(145) Max_Starts_from_Mtrl_Inv(164) Avg_Cost_of_MI(332)
 UNITS: material units

140: $Material_Transferred = Wafer_Starts * Material_Per_Wafer$

DEFN: Material Transferred from Inventory to Work in Process
 USES: Material_Per_Wafer(143) Wafer_Starts(152)
 AFFX: Mtrl_Invntry(138) Cost_of_Mtrl_Transferred_to_WIP(324)
 UNITS: material units/month

139: $Material_Purchase = Max(0, Mtrl_Forecast + MI_Adjustment)$

DEFN: Materials Purchased
 USES: MI_Adjustment(144) Mtrl_Forecast(146)
 AFFX: Mtrl_Invntry(138) Cost_of_Mtrl_Purchase(323)
 UNITS: material units/month

$$146: \text{Mtrl_Forecast} = \text{Material_Per_Wafer} * \text{Forecasted_Orders} / \text{Expected_Yield}$$

DEFN: Forecasted Materials Requirement
 USES: Expected_Yield(128) Forecasted_Orders(132) Material_Per_Wafer(143)
 AFFX: Material_Purchase(139)
 UNITS: material units/month

$$144: \text{MI_Adjustment} = \text{MI_Discrepancy} / \text{Time_to_Adjust_MI}$$

DEFN: Adjustment to Maintain Desired Level of Materials Inventory
 USES: MI_Discrepancy(145) Time_to_Adjust_MI(147)
 AFFX: Material_Purchase(139)
 UNITS: material units/month

$$145: \text{MI_Discrepancy} = \text{Desired_Material_Inventory} - \text{Mtrl_Invntry}$$

DEFN: Discrepancy Between Desired and Actual Materials Inventory
 USES: Desired_Material_Inventory(142) Mtrl_Invntry(138)
 AFFX: MI_Adjustment(144)
 UNITS: material units

$$142: \text{Desired_Material_Inventory} = \text{Desired_Material_Coverage} * (\text{Forecasted_Orders} / \text{Expected_Yield})$$

DEFN: Desired Level of Materials Inventory
 USES: Desired_Material_Coverage(141) Expected_Yield(128) Forecasted_Orders(132)
 AFFX: MI_Discrepancy(145)
 UNITS: material units

$$141: \text{Desired_Material_Coverage} = 8$$

DEFN: Desired Number of Months Sales in Materials Inventory
 AFFX: Desired_Material_Inventory(142)
 UNITS: months

$$143: \text{Material_Per_Wafer} = 1$$

DEFN: Required Number of Material Units per Wafer
 AFFX: Material_Transfered(140) Mtrl_Forecast(146) Max_Starts_from_Mtrl_Inv(164)
 UNITS: materials units/wafer

$$147: \text{Time_to_Adjust_MI} = 3$$

DEFN: Average Time Required to Make Adjustments to the Materials Ordering Rate
 AFFX: MI_Adjustment(144)
 UNITS: months

3.4 Wafer Starts, WIP and Finished Goods Inventory

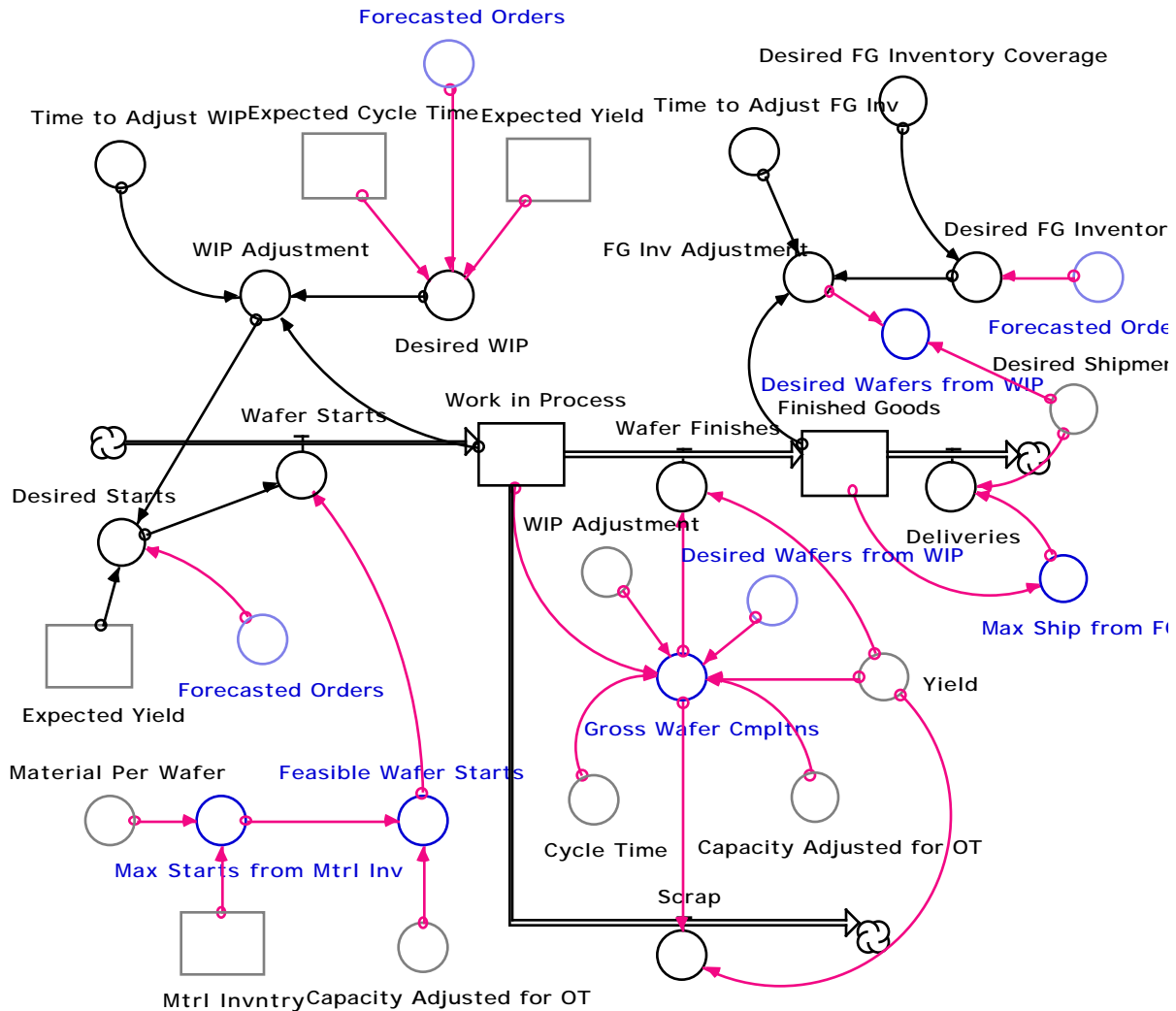

Work in process is increased by wafer starts and decreased by wafers completed and wafers that are scrapped. Actual wafers starts is equal to the minimum of the desired rate of wafers starts and the feasible rate of wafer starts. The desired rate of wafer starts is equal to the forecasted order rate divided by the expected manufacturing yield plus an adjustment for any discrepancy between the desired and actual levels of work in process inventory. The adjustment for work in process inventory is equal to the difference between the desired and actual WIP levels divided by the required adjustment time, set to be three months based upon the assumed quarterly budgeting and planning cycle. The desired level of work in process is equal to the forecasted order rate divided by the expected yield multiplied by the expected cycle time. The rate of feasible wafer starts is equal to minimum of the maximum possible starts given available materials inventory and the effective product capacity adjusted for the use of overtime. The maximum possible rate of starts given available materials inventory is equal to the current material inventory divided by the required

number of material units per wafer divided by the time required to fully deplete the materials inventory, here assumed to be one month. The effective capacity adjusted for overtime will be discussed in the following sub-section.

151: $Work_in_Process = Work_in_Process * (t-dt) + (Wafer_Starts - Scrap - Wafer_Finishes) * dt$
INIT: Desired_WIP

DEFN: Work in Process

USES: Desired_WIP(159) Scrap(153) Wafer_Finishes(154) Wafer_Starts(152)

AFFX: Gross_Wafer_Cmpltns(162) WIP_Adjustment(167) M_Cost_of_WIP(328)

Avg_M_Cost_of_WIP(334) Value_of_WIP(407)

UNITS: wafers

152: $Wafer_Starts = \min(Desired_Starts, Feasible_Wafer_Starts)$

DEFN: Wafers Started

USES: Desired_Starts(157) Feasible_Wafer_Starts(160)

AFFX: Material_Transfered(140) Work_in_Process(151) Capacity_Utilization(172)

M_Cost_of_Wafer_Starts(329) Budgeted_Wafer_Starts(366) Chng_in_Budg_Starts(367)

UNITS: wafers/month

157: $Desired_Starts = \text{Max}(0, WIP_Adjustment + (Forecasted_Orders) / Expected_Yield)$

DEFN: Desired Rate of Wafer Starts

USES: Expected_Yield(128) Forecasted_Orders(132) WIP_Adjustment(167)

AFFX: Wafer_Starts(152) Ratio_Desired_to_Potential_Starts(180)

UNITS: wafers/month

167: $WIP_Adjustment = (Desired_WIP - Work_in_Process) / Time_to_Adjust_WIP$

DEFN: Adjustment to Maintain Desired Level of Work in Process

USES: Desired_WIP(159) Time_to_Adjust_WIP(166) Work_in_Process(151)

AFFX: Desired_Starts(157) Gross_Wafer_Cmpltns(162)

UNITS: wafers/month

159: $Desired_WIP = Forecasted_Orders * Expected_Cycle_Time / Expected_Yield$

DEFN: Desired Level of Work in Process

USES: Expected_Cycle_Time(126) Expected_Yield(128) Forecasted_Orders(132)

AFFX: Work_in_Process(151) WIP_Adjustment(167)

UNITS: wafers

166: $Time_to_Adjust_WIP = 3$

DEFN: Average Time Required to Make Adjustment to Work in Process

AFFX: WIP_Adjustment(167)

UNITS: months

160: $Feasible_Wafer_Starts = \text{Min}(\text{Max_Starts_from_Mtrl_Inv}, \text{Capacity_Adjusted_for_OT})$

DEFN: Feasible Rate of Wafer Starts

USES: Capacity_Adjusted_for_OT(168) Max_Starts_from_Mtrl_Inv(164)

AFFX: Wafer_Starts(152)

UNITS: wafers/month

164: $Max_Starts_from_Mtrl_Inv = (Mtrl_Invntry / Material_Per_Wafer) / 1$

DEFN: Maximum Rate of Wafer Starts Given Material Inventory
 USES: Material_Per_Wafer(143) Mtrl_Invntry(138)
 AFFX: Feasible_Wafer_Starts(160) Desired_Cap_per_Month(175)
 UNITS: wafers/month

The rates of wafer completion and wafer discard are both determined by the rate of gross wafer completions. Gross wafer completion is equal to the minimum of the level of work in process divided by the current cycle time, capacity adjusted for overtime, and the desired rate of wafer transfers from WIP to finished goods inventory plus an adjustment for work in process discrepancies. The rate of wafer completion is equal to gross wafer completion multiplied by the current manufacturing yield while the rate of wafer discards is equal to gross wafer completion multiplied by one minus the current yield. The desired rate of wafer transfers from work in process to finished goods inventory is equal to the desired shipment rate, discussed earlier, plus an adjustment for any discrepancy between desired and actual finished goods inventory.

162: $Gross_Wafer_Cmpltns = \min((Work_in_Process/Cycle_Time), Capacity_Adjusted_for_OT, MAX(-WIP_Adjustment, 0) + Desired_Wafers_from_WIP/Yield)$

DEFN: Gross Wafer Completions
 USES: Capacity_Adjusted_for_OT(168) Cycle_Time(228) Desired_Wafers_from_WIP(158)
 WIP_Adjustment(167) Work_in_Process(151) Yield(265)
 AFFX: Wafer_Finishes(149) Scrap(153) Wafer_Finishes(154)
 UNITS: wafers/month

154: $Wafer_Finishes = Yield * Gross_Wafer_Cmpltns$

DEFN: Wafers Completed that Are Usable as Finished Products
 USES: Gross_Wafer_Cmpltns(162) Yield(265)
 AFFX: Finished_Goods(148) Work_in_Process(151) M_Cost_of_Work_Finish(326)
 M_Cost_of_Work_Finish(330) Budgeted_Wafer_Finishes(364) Chng_in_Budg_Wafer_Cmpltns(365)
 Capital_Volume_Variance(375) Lbr_Efficiency_Variance(376) OH_Volume_Variance(380)
 Incr_in_Cap_Cost_of_FGI(385) Incr_in_Labor_Cost_of_FG(388) OH_Cost_of_Work_Finished(391)
 UNITS: wafers/month

153: $Scrap = (1 - Yield) * Gross_Wafer_Cmpltns$

DEFN: Wafers Completed that Are Not Usable as Finished Products
 USES: Gross_Wafer_Cmpltns(162) Yield(265)
 AFFX: Work_in_Process(151)
 UNITS: wafers/month

158: $Desired_Wafers_from_WIP = FG_Inv_Adjustment + Desired_Shipments$

DEFN: Desired Wafers Transferred from Work in Process to Finished Goods Inventory
 USES: Desired_Shipments(123) FG_Inv_Adjustment(161)
 AFFX: Gross_Wafer_Cmpltns(162)
 UNITS: wafers/month

The level of finished goods inventory is increased by wafer completions and decreased by deliveries. The rate of wafer completion was discussed above. The rate of deliveries is equal to the minimum of the desired shipment rate, equation #123, and the maximum shipment rate given

available finished goods inventory. The maximum possible shipment rate given available inventory is equal to the level of finished goods inventory divided by the minimum time required to deplete the inventory stock, assumed to be one month. The adjustment to maintain finished goods inventory, which helps determine the rate of gross wafer completion, is calculated in the standard fashion. The adjustment is equal to the difference between the desired and actual inventory levels divided by the time required to adjust the actual inventory level. This time is assumed to be three months based upon the assumed quarterly budgeting and planning cycle. The desired level of finished goods inventory is equal to the forecasted order rate multiplied by the desired inventory coverage. The desired inventory coverage, the number of months sales desired in inventory, is assumed to be two months based upon data taken from Analog annual reports and the author's judgment.

148: $Finished_Goods = Finished_Goods * (t-dt) + (Wafer_Finishes - Deliveries) * dt$
 INIT: Desired_FG_Inventory

DEFN: Finished Goods Inventor
 USES: Deliveries(150) Desired_FG_Inventory(155) Wafer_Finishes(154)
 AFFX: FG_Inv_Adjustment(161) Max_Ship_from_FG(163) M_Cost_Finished_Goods(325)
 Avg_M_Cost_of_FG(333) Capital_Cost_of_FG_Inventory(384) Labor_Cost_of_Finished_Goods(387)
 OH_Cost_of_FGI(390) Avg_Cap_Cost_of_FGI(393) Avg_Lbr_Cost_of_FG(394)
 Avg_OH_Cost_of_FG(395)
 UNITS: wafers

149: $Wafer_Finishes = Yield * Gross_Wafer_Cmpltns$

DEFN: Wafer Completions that Are Usable as Finished Products
 USES: Gross_Wafer_Cmpltns(162) Yield(265)
 UNITS: wafers/month

150: $Deliveries = Min(Max_Ship_from_FG, Desired_Shipments)$

DEFN: Finished Goods Delivered
 USES: Desired_Shipments(123) Max_Ship_from_FG(163)
 AFFX: Shipments(116) Finished_Goods(148) M_Cost_of_Goods_Sold(327) Total_per_Unit_Cost(355)
 Cap_Cost_of_Goods_Sold(386) Labor_Cost_of_Goods_Sold(389) OH_Cost_of_Goods_Sold(392)
 Model_Sales_Revenue(432) Per_Unit_Cogs(660) Per_Unit_Gross_margin(661)
 UNITS: wafers/month

163: $Max_Ship_from_FG = Finished_Goods / 1$

DEFN: Maximum Rate of Shipments From Finished Goods Inventory
 USES: Finished_Goods(148)
 AFFX: Deliveries(150) Per_Unit_Op_Exp(662) Per_Unit_Op_Income(663)
 UNITS: wafers/month

161: $FG_Inv_Adjustment = (Desired_FG_Inventory - Finished_Goods) / Time_to_Adjust_FG_Inv$

DEFN: Adjustment to Wafer Completions to Maintain Finished Goods Inventory
 USES: Desired_FG_Inventory(155) Finished_Goods(148) Time_to_Adjust_FG_Inv(165)
 AFFX: Desired_Wafers_from_WIP(158) \

UNITS: wafers/month

155: $Desired_FG_Inventory = Desired_FG_Inventory_Coverage * Forecasted_Orders$

DEFN: Desired Level of Finished Goods Inventory

USES: $Desired_FG_Inventory_Coverage(156)$ $Forecasted_Orders(132)$

AFFX: $Finished_Goods(148)$ $FG_Inv_Adjustment(161)$

UNITS: wafers

156: $Desired_FG_Inventory_Coverage = 2$

DEFN: Desired Months Sales in Finished Goods Inventory

AFFX: $Desired_FG_Inventory(155)$

UNITS: months

165: $Time_to_Adjust_FG_Inv = 3$

DEFN: Average Time Required to Make Adjustments to Finished Goods Inventory

AFFX: $FG_Inv_Adjustment(161)$

UNITS: months

3.5 Production Capacity

3.5.1 The Production Function

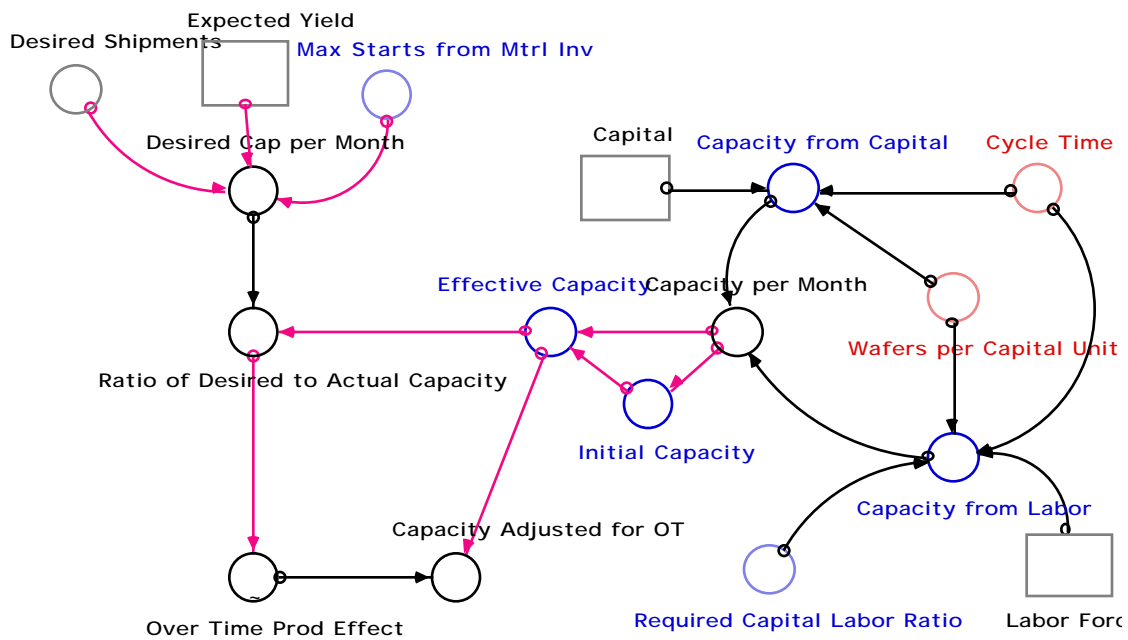

Maximum production capacity is a function the current stock of capital and labor, the current manufacturing cycle time, and the use of overtime. The assumed functional form is Cobb-Douglas with nested Leontief technology. Capacity adjusted for the use of overtime is equal to the total available effective capacity multiplied by a scaling factor that adjusts for the use of overtime. Available effective capacity is equal to the initial capacity level multiplied by the current capacity

level divided by the initial value raised to the four tenths power. This is a variant of the common Cobb-Douglas specification normalized around the initial value. The exponent was chosen based information taken from interviews about growth in effect capacity compared to productivity gains [Schneiderman 1992b]. These interviews indicate that a fourfold increase in base manufacturing productivity led to a slightly less than two fold increase in effective capacity. This declining return to improvement is due to bottlenecks in the system.

$$168: \text{Capacity_Adjusted_for_OT} = \text{Effective_Capacity} * \text{Over_Time_Prod_Effect}$$

DEFN: Effective Production Capacity Adjusted for the Use of Overtime

USES: Effective_Capacity(178) Over_Time_Prod_Effect(185)

AFFX: Feasible_Wafer_Starts(160) Gross_Wafer_Cmpltns(162)

UNITS: wafer completions/month

$$178: \text{Effective_Capacity} = \text{Initial_Capacity} * (\text{Capacity_per_Month} / \text{Initial_Capacity})^{.4}$$

DEFN: Effective Production Capacity

USES: Capacity_per_Month(171) Initial_Capacity(179)

AFFX: Capacity_Adjusted_for_OT(168) Capacity_Utilization(172)

Ratio_Desired_to_Potential_Starts(180) Ratio_of_Desired_to_Actual_Capacity(181)

UNITS: wafer completions/month

Unadjusted capacity per month, measured as the maximum number of completions per month, is equal to the minimum of capacity given the current stock of labor and capacity given the current stock of capital (a Leontief-fixed proportions- production function). The capacity given the capital stock is equal the number of available capital units multiplied by the number of wafers each capital unit can produce each cycle divided by the current cycle time. The capacity given the stock of labor is equal to the number of labor units divided by the required capital labor ratio multiplied by the capital unit productivity factor divided by the cycle time.

$$171: \text{Capacity_per_Month} = \text{Min}(\text{Capacity_from_Capital}, \text{Capacity_from_Labor})$$

DEFN: Production Capacity

USES: Capacity_from_Capital(169) Capacity_from_Labor(170)

AFFX: Effective_Capacity(178) Initial_Capacity(179)

UNITS: wafer completions/month

$$179: \text{Initial_Capacity} = \text{INIT}(\text{Capacity_per_Month})$$

DEFN: Initial Condition for Production Capacity

USES: Capacity_per_Month(171)

AFFX: Effective_Capacity(178)

UNITS: wafer completions/month

$$169: \text{Capacity_from_Capital} = \text{Capital} * \text{Wafers_per_Capital_Unit} / \text{Cycle_Time}$$

DEFN: Production Capacity Given the Available Capital Stock

USES: Capital(186) Cycle_Time(228) Wafers_per_Capital_Unit(183)

AFFX: Capacity_per_Month(171)

UNITS: wafer completions/month

170: Capacity_from_Labor =
 (Labor_Force/Required_Capital_Labor_Ratio)*Wafers_per_Capital_Unit/Cycle_Time

DEFN: Product Capacity Given the Available Labor Stock
 USES: Cycle_Time(228) Labor_Force(200) Required_Capital_Labor_Ratio(182)
 Wafers_per_Capital_Unit(183)
 AFFX: Capacity_per_Month(171)
 UNITS: wafer completions/month

The desired monthly capacity is equal to the lesser of the desired shipment rate divided by the expected wafer yield and the maximum possible number of starts given available materials inventory. The ratio of desired to actual production capacity is used to determine the amount of overtime usage.

175: Desired_Cap_per_Month = MIN(Desired_Shipments/Expected_Yield,Max_Starts_from_Mtrl_Inv)

DEFN: Desired Monthly Product Capacity
 USES: Desired_Shipments(123) Expected_Yield(128) Max_Starts_from_Mtrl_Inv(164)
 AFFX: Ratio_of_Desired_to_Actual_Capacity(181)
 UNITS: wafer completions/month

181: Ratio_of_Desired_to_Actual_Capacity = Desired_Cap_per_Month/Effective_Capacity

DEFN: Ration of Desired to Actual Monthly Production Capacity
 USES: Desired_Cap_per_Month(175) Effective_Capacity(178)
 AFFX: Efc_of_Cap_Util_on_Time_Thru_Fab(60) Over_Time_Prod_Effect(185)
 UNITS: dimensionless

The use of overtime is determined by the ratio of desired to actual production capacity. As this ratio increases the effective capacity also increases, from the use of overtime, but at a decreasing rate. The declining return from the use of overtime results from diminishing return to additional worker hours beyond their normal workload. The function relating the ratio of desired to actual capacity to over time is assumed to be increasing, with a negative second derivative, and to approach 1.25 as the ratio of desired to actual capacity grows beyond one and a half.

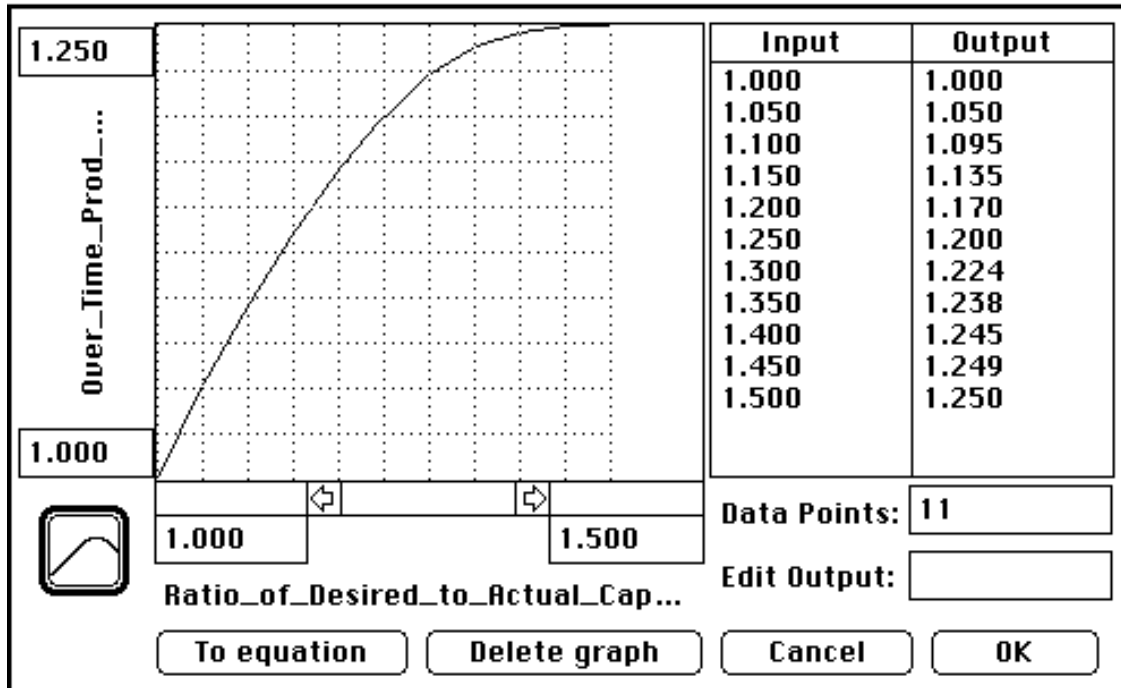

185: Over_Time_Prod_Effect = GRAPH(Ratio_of_Desired_to_Actual_Capacity)
 DATA: (1.00, 1.00), (1.05, 1.05), (1.10, 1.095), (1.15, 1.135), (1.20, 1.17), (1.25, 1.20), (1.30, 1.23), (1.35, 1.24), (1.40, 1.25), (1.45, 1.25), (1.50, 1.25)

DEFN: Effect of the Use of Overtime on Productivity
 USES: Ratio_of_Desired_to_Actual_Capacity(181)
 AFFX: Capacity_Adjusted_for_OT(168)
 UNITS: dimensionless



Capacity utilization is measured as the number of wafer starts divided by the current effective capacity while the ratio of desired to actual starts is calculated as the desired start rate divided by effective capacity.

172: Capacity_Utilization = Wafer_Starts/Effective_Capacity

DEFN: Capacity Utilization
 USES: Effective_Capacity(178) Wafer_Starts(152)
 UNITS: dimensionless

180: Ratio_Desired_to_Potential_Starts = Desired_Starts/Effective_Capacity

DEFN: Ration of Desired to Potential Wafer Starts
 USES: Desired_Starts(157) Effective_Capacity(178)
 AFFX: Effect_of_Dem_Sup_Balance_on_Price(429)
 UNITS: dimensionless

3.5.2 The Desired Capacity Level

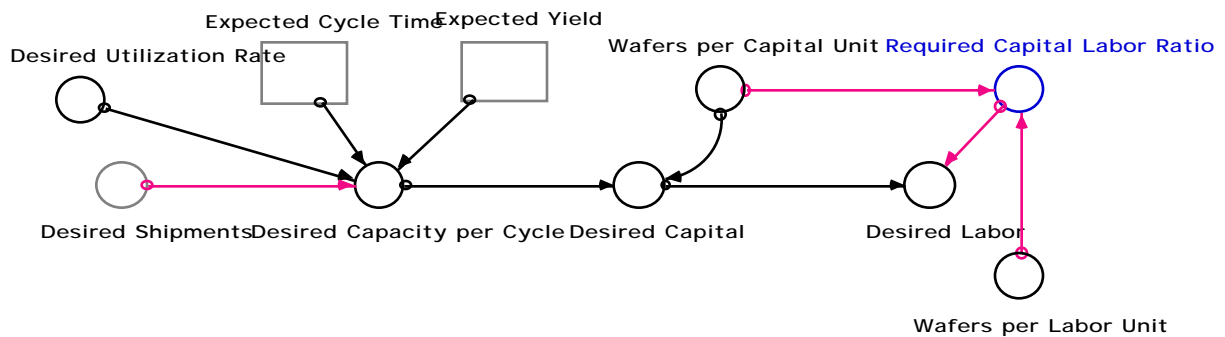

The acquisition of both capital and labor requires the determination of the capacity level measured in both capital and labor units. The desired production capacity per cycle is equal to the desired shipment rate multiplied by the expected cycle time divided by the expected wafer yield adjusted for the desired utilization fraction, assumed to be 90%. The desired capital stock is equal to the desired capacity per cycle divided by the number of wafers that each capital unit can produce each cycle. The desired stock of labor is equal to the desired capital stock multiplied by the required capital labor ratio. The required capital labor ratio is equal to the productivity per capital unit divided by the productivity per labor unit. Productivity per unit is assumed to be 5,000 and 15,000 for capital and labor respectively based upon the calibration of the model to actual unit sales and employment data.

173: $\text{Desired_Capacity_per_Cycle} = (\text{Expected_Cycle_Time} * \text{Desired_Shipments} / \text{Expected_Yield}) / \text{Desired_Utilization_Rate}$

DEFN: Desired Production Capacity Per Cycle
 USES: Desired_Shipments(123) Desired_Utilization_Rate(177) Expected_Cycle_Time(126)
 Expected_Yield(128)
 AFFX: Desired_Capital(174)
 UNITS: wafer completions/cycle

177: $\text{Desired_Utilization_Rate} = .9$

DEFN: Desired Capacity Utilization
 AFFX: Desired_Capacity_per_Cycle(173)
 UNITS: dimensionless

174: $\text{Desired_Capital} = \text{Desired_Capacity_per_Cycle} / \text{Wafers_per_Capital_Unit}$

DEFN: Desired Capital Stock
 USES: Desired_Capacity_per_Cycle(173) Wafers_per_Capital_Unit(183)
 AFFX: Desired_Labor(176) Capital(186) Capital_Discrepancy(195)
 UNITS: capital units

176: $\text{Desired_Labor} = \text{Desired_Capital} * \text{Required_Capital_Labor_Ratio}$

DEFN: Desired Stock of Labor

USES: Desired_Capital(174) Required_Capital_Labor_Ratio(182)

AFFX: Labor_Force(200) Labor_Discrepancy(205)

UNITS: laborers

182: $\text{Required_Capital_Labor_Ratio} = \text{Wafers_per_Capital_Unit} / \text{Wafers_per_Labor_Unit}$

DEFN: Required Capital Labor Ratio

USES: Wafers_per_Capital_Unit(183) Wafers_per_Labor_Unit(184)

AFFX: Capacity_from_Labor(170) Desired_Labor(176)

UNITS: capital units/laborer

183: $\text{Wafers_per_Capital_Unit} = 5000$

DEFN: Wafers Produced per Capital Unit

AFFX: Capacity_from_Capital(169) Capacity_from_Labor(170) Desired_Capital(174)

Required_Capital_Labor_Ratio(182) Productivity_per_Unit(262)

UNITS: wafers/capital unit/cycle

184: $\text{Wafers_per_Labor_Unit} = 15000$

DEFN: Wafers Produced per Labor Unit

AFFX: Required_Capital_Labor_Ratio(182)

UNITS: wafers/labor unit/cycle

3.6 Factor Acquisition

3.6.1 Capital

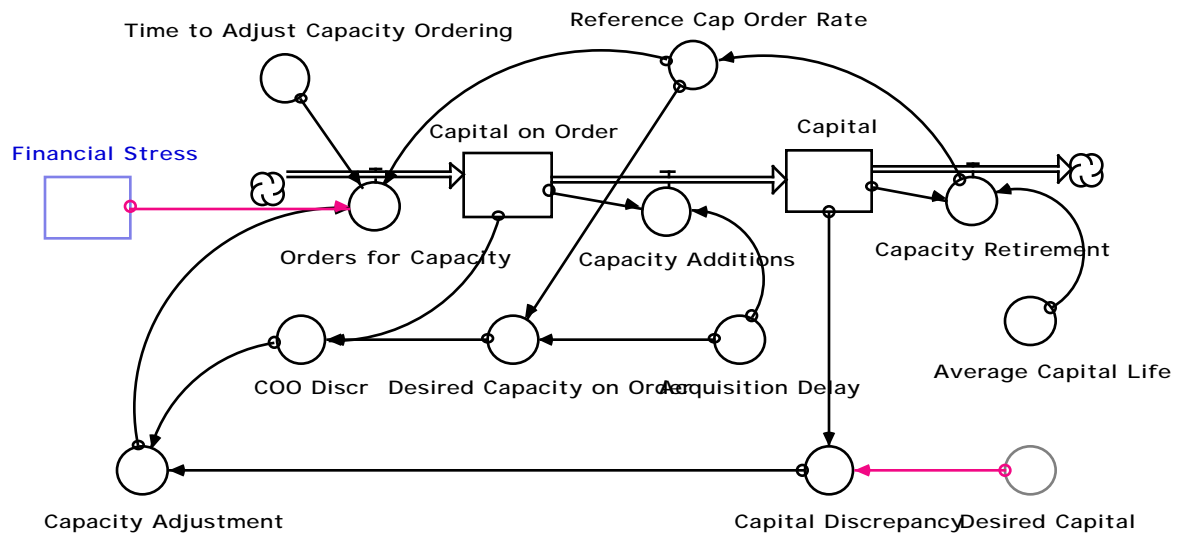

The structure for capital acquisition follows the standard format [Mass 1975, Forrester 1961]. The available capital stock is increased by additions and decreased by retirements. The rate of capital additions is equal to stock of capital on order divided by the average acquisition delay, assumed to be twelve months. The rate of capital retirement is equal the current capital stock divided by the average capital life, assumed to be ten years.

186: $Capital = Capital * (t-dt) + (Capacity_Additions - Capacity_Retirement) * dt$
 INIT: Desired_Capital

DEFN: Capital
 USES: Capacity_Additions(187) Capacity_Additions(191) Capacity_Retirement(188)
 Desired_Capital(174)
 AFFX: Capacity_from_Capital(169) Capacity_Retirement(188) Capital_Discrepancy(195)
 Net_Value_of_Capital_Stock(453)
 UNITS: capital units

187: $Capacity_Additions = Capital_on_Order / Acquisition_Delay$

DEFN: Additions to the Capital Stock
 USES: Acquisition_Delay(192) Capital_on_Order(189)
 AFFX: Capital(186) Capital_on_Order(189) Cost_of_New_Capacity_Purchases(454)
 UNITS: capital units/month

192: $Acquisition_Delay = 12$

DEFN: Average Time Required to Acquire Capital
 AFFX: Capacity_Additions(187) Capacity_Additions(191) Desired_Capacity_on_Order(197)
 UNITS: months

188: $Capacity_Retirement = Capital / Average_Capital_Life$

DEFN: Capital Retired from Service
 USES: Average_Capital_Life(193) Capital(186)
 AFFX: Capital(186) Reference_Cap_Order_Rate(198)
 UNITS: capital units/month

193: Average_Capital_Life = 120

DEFN: Average Capital Lifetime
 AFFX: Capacity_Retirement(188)
 UNITS: months

The level of capital on order is increased by new orders and decreased by additions to the capital stock. The rate of capacity additions is discussed above. The rate of capacity ordering is equal to the reference capital order rate, which is equal to the discard rate, plus adjustments for discrepancies between the desired and actual levels of capital and capital on order. The rate of capacity ordering is also affected by the quantity one minus financial stress. Financial stress is an index, confined to the interval [0,1], that represents management's willingness to take actions specifically focused on improving the short run profitability of the firm. It will be discussed more thoroughly in section #11. Its effect in this sector is to limit the purchase of new capital when management is focusing on improving short term profitability.

189: Capital_on_Order = Capital_on_Order *(t-dt) + (Orders_for_Capacity - Capacity_Additions) * dt
 INIT: Desired_Capacity_on_Order

DEFN: Capital on Order
 USES: Capacity_Additions(187) Capacity_Additions(191) Desired_Capacity_on_Order(197)
 Orders_for_Capacity(190)
 AFFX: Capacity_Additions(187) Capacity_Additions(191) COO_Discr(196)
 UNITS: capital units

191: Capacity_Additions = Capital_on_Order/Acquisition_Delay

DEFN: Additions to the Capital Stock
 USES: Acquisition_Delay(192) Capital_on_Order(189)
 AFFX: Capital(186) Capital_on_Order(189) Cost_of_New_Capacity_Purchases(454)
 UNITS: capital units/month

190: Orders_for_Capacity = Max(((1-Financial_Stress)*((Capacity_Adjustment/Time_to_Adjust_Capacity_Ordering)))+(Reference_Cap_Order_Rate),0)

DEFN: Orders for New Capital
 USES: Capacity_Adjustment(194) Financial_Stress(552) Reference_Cap_Order_Rate(198)
 Time_to_Adjust_Capacity_Ordering(199)
 AFFX: Capital_on_Order(189)
 UNITS: capital units/month

The total adjustment for discrepancies between the desired and actual levels is equal to the sum of the difference between desired and actual capital on order and the difference between desired and actual capital stock divided by the time required to adjust the ordering stream. The discrepancy

between desired and actual capital on order is equal to the desired level of capital on order minus the current level. The desired level of capital on order is equal to the reference capital order rate, the discard rate, multiplied by the average capital acquisition delay. The time required to adjust the capital order rate is assumed to be three months based upon the assumed quarterly budgeting and planning cycle. The difference between the desired and actual capital stock also affects the order rate. Changes in the desired capital stock are perceived with a twelve month delay which represents the time required for management to recognize changes in the desired capital stock and act upon them.

194: $\text{Capacity_Adjustment} = \text{COO_Discr} + \text{Capital_Discrepancy}$

DEFN: Adjustment to the Capital Ordering Stream
 USES: $\text{Capital_Discrepancy}(195)$ $\text{COO_Discr}(196)$
 AFFX: $\text{Orders_for_Capacity}(190)$
 UNITS: capital units

196: $\text{COO_Discr} = \text{Desired_Capacity_on_Order} - \text{Capital_on_Order}$

DEFN: Discrepancy Between Desired and Actual Capital on Order
 USES: $\text{Capital_on_Order}(189)$ $\text{Desired_Capacity_on_Order}(197)$
 AFFX: $\text{Capacity_Adjustment}(194)$
 UNITS: capital units

197: $\text{Desired_Capacity_on_Order} = \text{Acquisition_Delay} * \text{Reference_Cap_Order_Rate}$

DEFN: Desired Capital on Order
 USES: $\text{Acquisition_Delay}(192)$ $\text{Reference_Cap_Order_Rate}(198)$
 AFFX: $\text{Capital_on_Order}(189)$ $\text{COO_Discr}(196)$
 UNITS: capital units

198: $\text{Reference_Cap_Order_Rate} = \text{Capacity_Retirement}$

DEFN: Reference Capital Order Rate
 USES: $\text{Capacity_Retirement}(188)$
 AFFX: $\text{Orders_for_Capacity}(190)$ $\text{Desired_Capacity_on_Order}(197)$
 UNITS: capital units/month

199: $\text{Time_to_Adjust_Capacity_Ordering} = 3$

DEFN: Average Time Required to Adjust the Capital Ordering Rate
 AFFX: $\text{Orders_for_Capacity}(190)$
 UNITS: months

195: $\text{Capital_Discrepancy} = \text{SMTH1}(\text{Desired_Capital}, 12) - \text{Capital}$

DEFN: Discrepancy Between the Desired and Actual Capital Stock
 USES: $\text{Capital}(186)$ $\text{Desired_Capital}(174)$
 AFFX: $\text{Capacity_Adjustment}(194)$
 UNITS: capital units

3.6.2 Labor

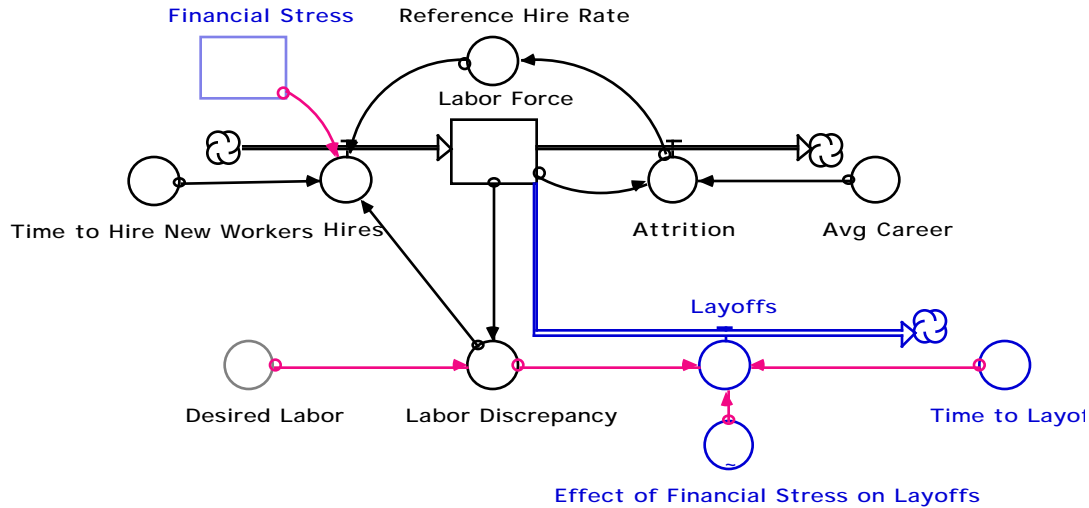

The available stock of labor is increased by hiring and decreased by attrition and lay-offs. Hiring is equal to the reference hire rate, the attrition rate, plus an adjustment for the discrepancy between the desired and actual labor stocks. The adjustment is equal to the discrepancy between the desired and actual labor levels divided by the time required to adjust the hiring stream, assumed to be six months. Changes in the desired labor level are assumed to be perceived with a twelve month delay. The attrition rate is equal to the current labor stock divided by the average career length, set to ten years based upon data taken from interviews [Stata 1993, Palmer 1993].

200: Labor_Force = Labor_Force *(t-dt) + (Hires - Attrition - Layoffs) * dt
 INIT: Desired_Labor

DEFN: Labor Force

USES: Attrition(202) Desired_Labor(176) Hires(201) Layoffs(203)

AFFX: Capacity_from_Labor(170) Attrition(202) Labor_Discrepancy(205)

Annual_Average_Layoff_Rate(276) Manuf_TQ_Support_Required(306) Labor_Payments(350)

Budgeted_Labor_Use(358) Chng_in_Budgeted_Lbr_Use(359)

UNITS: laborers

201: Hires = MAX(0,((1-
 Financial_Stress)*(Labor_Discrepancy/Time_to_Hire_New_Workers))+Reference_Hire_Rate)

DEFN: Labor Hires

USES: Financial_Stress(552) Labor_Discrepancy(205) Reference_Hire_Rate(206)

Time_to_Hire_New_Workers(207)

AFFX: Labor_Force(200)

UNITS: laborers/month

206: Reference_Hire_Rate = Attrition

DEFN: Reference Labor Hiring Rate

USES: Attrition(202)

AFFX: Hires(201)

UNITS: laborers/month

205: Labor_Discrepancy = SMTH1(Desired_Labor,12)-Labor_Force

DEFN: Discrepancy Between the Desired and Actual Labor Force

USES: Desired_Labor(176) Labor_Force(200)

AFFX: Hires(201) Layoffs(203)

UNITS: laborers

207: Time_to_Hire_New_Workers = 6

DEFN: Average Time Required to Adjust the Labor Hiring Rate

AFFX: Hires(201)

UNITS: months

202: Attrition = Labor_Force/Avg_Career

DEFN: Attrition in the Labor Force

USES: Avg_Career(204) Labor_Force(200)

AFFX: Labor_Force(200) Reference_Hire_Rate(206)

UNITS: laborers/month

204: Avg_Career = 120

DEFN: Average Career Length for Members of the Labor Force

AFFX: Attrition(202)

UNITS: months

The rate of lay-offs is equal to any negative difference between the desired and actual labor stocks divided by the time required to lay-off workers. This rate is also affected by a non-linear function of the current level of financial stress. The function is specified so that management will resist lay-offs until financial stress begins to reach extreme levels(close to one). Once extreme levels of financial stress are reached, management will lay-off as many of the workers as are needed to reduce the labor force to the target level.

203: Layoffs = MAX((-Labor_Discrepancy)*Effect_of_Financial_Stress_on_Layoffs/Time_to_Layoffs,0)

DEFN: Reduction in the Labor Force Through Lay-Offs

USES: Effect_of_Financial_Stress_on_Layoffs(209) Labor_Discrepancy(205) Time_to_Layoffs(208)

AFFX: Labor_Force(200) Annual_Average_Layoff_Rate(276)

UNITS: laborers/month

208: Time_to_Layoffs = 3

DEFN: Time Required to Lay-Off Labor

AFFX: Layoffs(203)

UNITS: months

The effect of financial stress on management's willingness to lay-off excess labor is operationalized as a strictly increasing function with a positive second derivative. Management is will not resort to lay-offs until financial stress grows beyond .7. At this level and above,

management is assumed to be very focused on boosting short term profitability and lay-offs may help accomplish that goal.

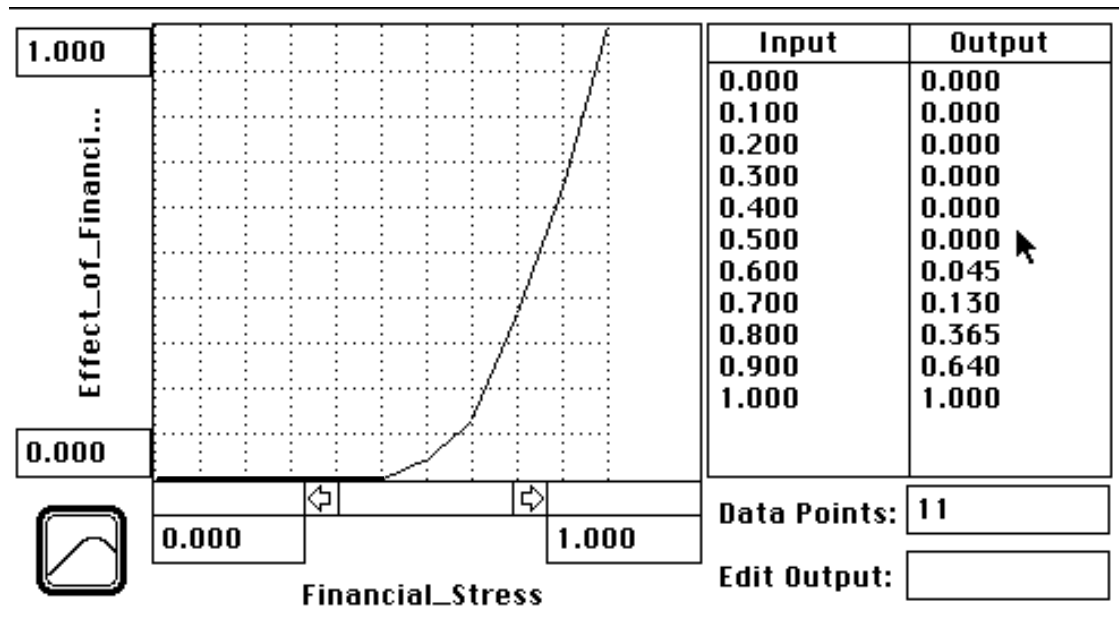

209: Effect_of_Financial_Stress_on_Layoffs = GRAPH(Financial_Stress)
 DATA: (0.00, 0.00), (0.1, 0.00), (0.2, 0.00), (0.3, 0.00), (0.4, 0.00), (0.5, 0.00), (0.6, 0.045), (0.7, 0.13), (0.8, 0.365), (0.9, 0.64), (1, 1.00)

DEFN: The Effect of Financial Stress on Lay-Offs
 USES: Financial_Stress(552)
 AFFX: Layoffs(203)
 UNITS: dimensionless

4. Improvement

4.0 Overview

The core improvement equation in this section is a modified version of the "Half-Life" model first suggested by Schneiderman [1988]. The construct "commitment to improvement" is also defined, and the dynamics of the commitment process are described. The section also deals with the allocation of resources to support the improvement effort and the resulting effect on morale and the aggregate improvement rate.

4.1 Manufacturing

There are four key performance measures in the manufacturing improvement sector: manufacturing cycle time, manufacturing yield, product defects, and on-time delivery. The improvement process is identically represented for each measure.

4.1.1 Cycle Time

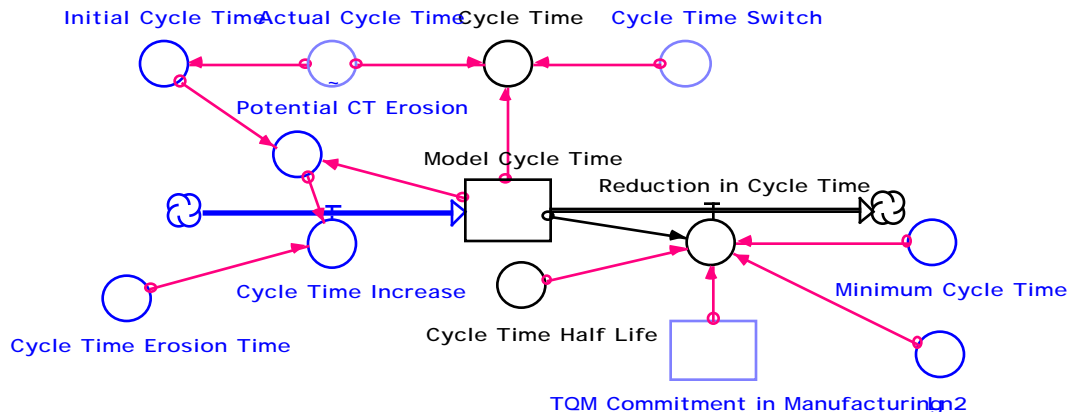

228: $Cycle_Time = Model_Cycle_Time * (1 - Cycle_Time_Switch) + Actual_Cycle_Time * Cycle_Time_Switch$

DEFN: Manufacturing Cycle Time

USES: Actual_Cycle_Time(671) Cycle_Time_Switch(652) Model_Cycle_Time(213)

AFFX: Chg_in_Exp_Cycle_Time(127) Gross_Wafer_Cmpltns(162) Capacity_from_Capital(169)

Manufacturing cycle time is reduced by improvement effort and increased by erosion.

The increase or "erosion" in cycle time is equal to the potential cycle time erosion, the initial value minus the current level divided by the erosion time constant, here assumed to be sixty months.

The continual, erosion induced, decay of cycle time towards its initial value represents the fact that productivity improvements produced by a TQM process are not necessarily permanent. In fact, as modeled, TQM effort must remain at a minimum level to maintain improvements. There is evidence to suggest that this was the case at Analog. After the lay-off in the summer of 1990 key performance measures at Analog fell significantly [Schneiderman 1992b].

213: $Model_Cycle_Time = Model_Cycle_Time * (t-dt) + (Cycle_Time_Increase - Reduction_in_Cycle_Time) * dt$

INIT: Actual_Cycle_Time

DEFN: Exogenously Generated Manufacturing Cycle Time

USES: Actual_Cycle_Time(671) Cycle_Time_Increase(214) Reduction_in_Cycle_Time(215)

AFFX: Reduction_in_Cycle_Time(215) Cycle_Time(228) Potential_CT_Erosion(255)

UNITS: months

214: $Cycle_Time_Increase = Potential_CT_Erosion / Cycle_Time_Erosion_Time$

DEFN: Increase in Manufacturing Cycle Time Due to Erosion

USES: Cycle_Time_Erosion_Time(229) Potential_CT_Erosion(255)

AFFX: Model_Cycle_Time(213)

UNITS: months/month

255: $Potential_CT_Erosion = Initial_Cycle_Time - Model_Cycle_Time$

DEFN: Potential Increase in Cycle Time Due to Erosion
 USES: Initial_Cycle_Time(236) Model_Cycle_Time(213)
 AFFX: Cycle_Time_Increase(214)
 UNITS: months

236: Initial_Cycle_Time = INIT(Actual_Cycle_Time)

DEFN: Initial Condition for Manufacturing Cycle Time
 USES: Actual_Cycle_Time(671)
 AFFX: Potential_CT_Erosion(255)
 UNITS: months

229: Cycle_Time_Erosion_Time = 60

DEFN: Average Time Required for Manufacturing Cycle Time to Reach its Initial Condition via Erosion
 AFFX: Cycle_Time_Increase(214) Incr_in_Ind_Cycle_Time(574)
 UNITS: months

The reduction in cycle time is based upon the "Half-Life Model" [Schneiderman 1988]. The rate of improvement is equal to the gap between the current and minimum cycle time divided by a time constant that is equal to the "half-life" estimated for cycle time divided by the natural logarithm of two. The division by natural log of two, converts from the estimated half-life to a time constant. The improvement rate is also affected by the commitment to TQM in manufacturing. This construct, discussed more fully in a subsequent section, is defined over the zero one interval and measures the percent of the full time equivalent workforce that is currently using TQM methods. The initial cycle time is set to the actual historical level. The improvement half-life is set to six months based upon Analog's actual improvement experience and estimates made by Schneiderman [1988, Kaplan 1990a]. The minimum cycle time is assumed to be one and one half months, a value well below that eventually achieved by Analog.

215: Reduction_in_Cycle_Time = ((Model_Cycle_Time - Minimum_Cycle_Time) / (Cycle_Time_Half_Life / Ln2)) * TQM_Commitment_in_Manufacturing

DEFN: Reduction in Cycle Time Due to Improvement
 USES: Cycle_Time_Half_Life(230) Ln2(241) Minimum_Cycle_Time(245) Model_Cycle_Time(213)
 TQM_Commitment_in_Manufacturing(270)
 AFFX: Model_Cycle_Time(213)
 UNITS: months/month

230: Cycle_Time_Half_Life = 6

DEFN: Half-Life for Reducing Manufacturing Cycle Time
 AFFX: Reduction_in_Cycle_Time(215) Decr_in_Cycle_Time(575)
 UNITS: months

245: Minimum_Cycle_Time = 1.5

DEFN: Minimum Cycle Time

AFFX: Reduction_in_Cycle_Time(215) Decr_in_Cycle_Time(575)

UNITS: months

4.1.2 Yield

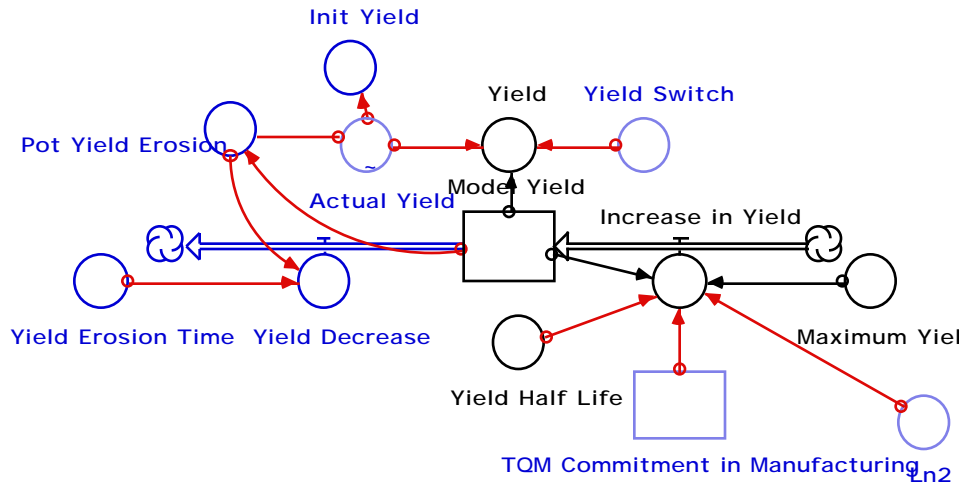

265: $Yield = (Model_Yield * (1 - Yield_Switch)) + (Actual_Yield * Yield_Switch)$

DEFN: Manufacturing Yield

USES: Actual_Yield(687) Model_Yield(219) Yield_Switch(668)

AFFX: Chg_in_Exp_Yield(129) Wafer_Finishes(149) Scrap(153) Wafer_Finishes(154)

Gross_Wafer_Cmpltns(162) Productivity_per_Unit(262) M_Cost_of_Work_Finish(326)

M_Cost_of_Work_Finish(330) Value_of_WIP(407)

UNITS: dimensionless

Yield is determined using a formulation identical to that of cycle time. The erosion time constant is longer, ten years, under the assumption the fundamental improvement in wafer yield are easier to maintain than those in cycle time. The half-life for improving yield is set to 18 months using estimates based upon Analog's actual improvement experience. The maximum yield is set to 55%, again higher than that achieved by Analog.

219: $Model_Yield = Model_Yield * (t-dt) + (Increase_in_Yield - Yield_Decrease) * dt$

INIT: Actual_Yield

DEFN: Endogenously Generated Manufacturing Yield

USES: Actual_Yield(687) Increase_in_Yield(220) Yield_Decrease(221)

AFFX: Increase_in_Yield(220) Pot_Yield_Erosion(260) Yield(265)

UNITS: dimensionless

221: $Yield_Decrease = Pot_Yield_Erosion / Yield_Erosion_Time$

DEFN: Decrease in Wafer Yield Due to Erosion
 USES: Pot_Yield_Erosion(260) Yield_Erosion_Time(266)
 AFFX: Model_Yield(219)
 UNITS: 1/months

260: Pot_Yield_Erosion = Model_Yield-Init_Yield

DEFN: Potential Decrease in Manufacturing Yield Due to Erosion
 USES: Init_Yield(239) Model_Yield(219)
 AFFX: Yield_Decrease(221)
 UNITS: dimensionless

239: Init_Yield = INIT(Actual_Yield)

DEFN: Initial Condition for Manufacturing Yield
 USES: Actual_Yield(687)
 AFFX: Pot_Yield_Erosion(260) Pot_Ind_Yield_Erosion(600) Price_Reduction_from_Yield(608)
 UNITS: dimensionless

266: Yield_Erosion_Time = 120

DEFN: Average Time Required for Manufacturing Yield to Reach its Initial Condition via Erosion
 AFFX: Yield_Decrease(221) Decr_in_Yield(578)
 UNITS: months

220: Increase_in_Yield = ((Maximum_Yield-
 Model_Yield)/(Yield_Half_Life/Ln2))*TQM_Commitment_in_Manufacturing

DEFN: Increase in Yield Due to Improvement Effort
 USES: Ln2(241) Maximum_Yield(243) Model_Yield(219) TQM_Commitment_in_Manufacturing(270)
 Yield_Half_Life(267)
 AFFX: Model_Yield(219)
 UNITS: 1/months

243: Maximum_Yield = .55

DEFN: Theoretical Maximum Wafer Yield
 AFFX: Increase_in_Yield(220) Incr_in_Ind_Yield(577)
 UNITS: dimensionless

267: Yield_Half_Life = 18

DEFN: Improvement Half-Life for Manufacturing Yield
 AFFX: Increase_in_Yield(220) Incr_in_Ind_Yield(577)
 UNITS: months

4.1.3 Defects

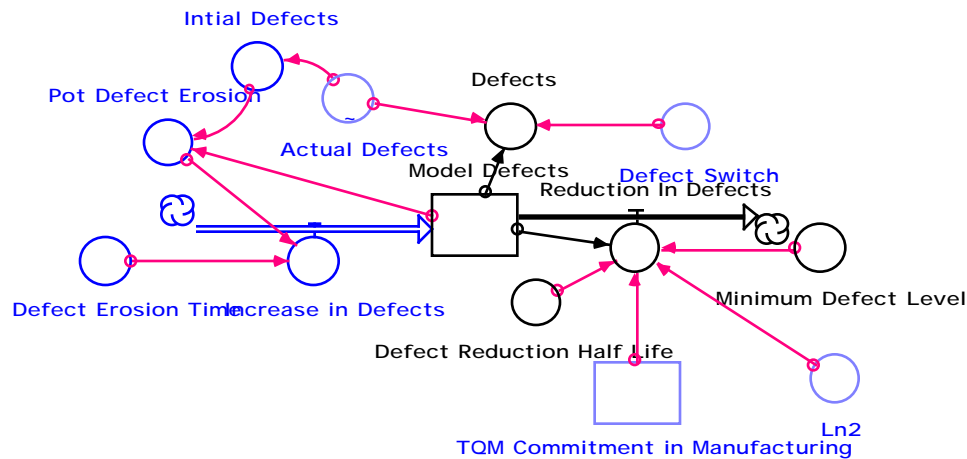

$$231: \text{Defects} = \text{Model_Defects} * (1 - \text{Defect_Switch}) + \text{Actual_Defects} * \text{Defect_Switch}$$

DEFN: Outgoing Defects

USES: Actual_Defects(672) Defect_Switch(653) Model_Defects(216)

AFFX: Perceived_Defects(85) Chng_in_Per_Defects(86) Productivity_per_Unit(262)

UNITS: defects/million outgoing units

The level of outgoing product defects is also similarly formulated. The time constant for defect erosion is assumed to be ten years. The improvement half-life is set to four months based upon Analog's actual improvement experience, and the minimum defect level is set to 100 parts per million, approximately equal to Analog's best average performance.

$$216: \text{Model_Defects} = \text{Model_Defects} * (t - dt) + (\text{Increase_in_Defects} - \text{Reduction_In_Defects}) * dt$$

INIT: Actual_Defects

DEFN: Endogenously Generated Outgoing Product Defects

USES: Actual_Defects(672) Increase_in_Defects(217) Reduction_In_Defects(218)

AFFX: Reduction_In_Defects(218) Defects(231) Pot_Defect_Erosion(259)

UNITS: defects/million outgoing units

$$217: \text{Increase_in_Defects} = \text{Pot_Defect_Erosion} / \text{Defect_Erosion_Time}$$

DEFN: Increase in Outgoing Product Defects Due to Erosion

USES: Defect_Erosion_Time(232) Pot_Defect_Erosion(259)

AFFX: Model_Defects(216)

UNITS: defects/million outgoing units/month

$$259: \text{Pot_Defect_Erosion} = \text{Intial_Defects} - \text{Model_Defects}$$

DEFN: Potential Increase in Outgoing Product Defects Due to Erosion

USES: Intial_Defects(240) Model_Defects(216)

AFFX: Increase_in_Defects(217)

UNITS: defects/million outgoing units

$$240: \text{Intial_Defects} = \text{INIT}(\text{Actual_Defects})$$

DEFN: Initial Condition for Outgoing Product Defects

USES: Actual_Defects(672)

AFFX: Pot_Defect_Erosion(259)

UNITS: defects/million outgoing units

232: Defect_Erosion_Time = 120

DEFN: Average Time Required for Outgoing Defects to Return to the Initial Level Via Erosion

AFFX: Increase_in_Defects(217)

UNITS: months

218: Reduction_In_Defects = ((Model_Defects-
Minimum_Defect_Level)/(Defect_Reduction_Half_Life/Ln2))*TQM_Commitment_in_Manufacturing

DEFN: Reduction in Outgoing Defects Due to Improvement

USES: Defect_Reduction_Half_Life(233) Ln2(241) Minimum_Defect_Level(246) Model_Defects(216)

TQM_Commitment_in_Manufacturing(270)

AFFX: Model_Defects(216)

UNITS: defects/million outgoing units/months

233: Defect_Reduction_Half_Life = 4

DEFN: Outgoing Defect Reduction Half-Life

AFFX: Reduction_In_Defects(218) Industry_Defect_HalfLife(587)

UNITS: months

246: Minimum_Defect_Level = 100

DEFN: Theoretical Minimum Outgoing Defect Level

AFFX: Reduction_In_Defects(218) Industry_Best_Practice_for_Defects(584)

UNITS: defects/million outgoing units

4.1.4 On Time Delivery

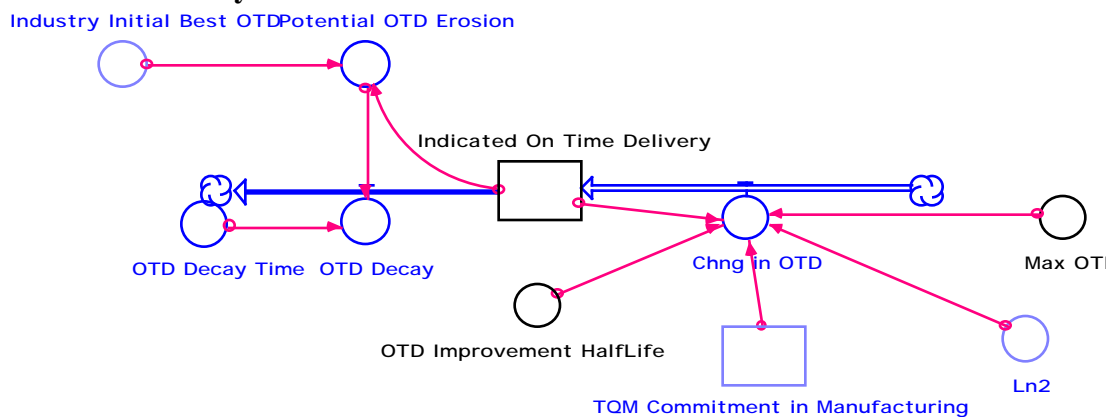

Indicated on-time delivery is also similarly formulated. The erosion time constant is set to seventy-two months based upon the author's judgment. The improvement half-life is six months, again based upon Analog's actual experience, and the maximum on-time delivery is 100%.

210: $\text{Indicated_On_Time_Delivery} = \text{Indicated_On_Time_Delivery} * (t-dt) + (\text{Chng_in_OTD} - \text{OTD_Decay}) * dt$

INIT: Actual_OTD

DEFN: Indicated On-Time Delivery Percentage

USES: Actual_OTD(678) Chng_in_OTD(211) OTD_Decay(212)

AFFX: Effective_OnTime_Delivery(95) Chng_in_OTD(211) Potential_OTD_Erosion(256)

UNITS: dimensionless

212: $\text{OTD_Decay} = \text{Potential_OTD_Erosion} / \text{TOD_Decay_Time}$

DEFN: Reduction in On-Time Delivery Percentage Due to Erosion

USES: Potential_OTD_Erosion(256) TOD_Decay_Time(264)

AFFX: Indicated_On_Time_Delivery(210)

UNITS: 1/months

256: $\text{Potential_OTD_Erosion} = \text{MAX}(\text{Indicated_On_Time_Delivery} - \text{Industry_Initial_Best_OTD}, 0)$

DEFN: Potential Reduction in On-Time Delivery Due to Erosion

USES: Indicated_On_Time_Delivery(210) Industry_Initial_Best_OTD(589)

AFFX: OTD_Decay(212)

UNITS: dimensionless

264: $\text{TOD_Decay_Time} = 72$

DEFN: Average Time Required for the On-Time Delivery Percentage to Return to Its Initial Condition Via Erosion

AFFX: OTD_Decay(212)

UNITS: months

211: $\text{Chng_in_OTD} = ((\text{Max_OTD} - \text{Indicated_On_Time_Delivery}) / (\text{OTD_Improvement_HalfLife} / \text{Ln}2)) * \text{TQM_Commitment_in_Manufacturing}$

DEFN: Increase in the On-Time Delivery Percentage Due to Improvement Effort

USES: Indicated_On_Time_Delivery(210) Ln2(241) Max_OTD(244) OTD_Improvement_HalfLife(249)

TQM_Commitment_in_Manufacturing(270)

AFFX: Indicated_On_Time_Delivery(210)

UNITS: 1/months

244: $\text{Max_OTD} = 1$

DEFN: Maximum Possible On-Time Delivery Percentage

AFFX: Chng_in_OTD(211)

UNITS: dimensionless

249: $\text{OTD_Improvement_HalfLife} = 6$

DEFN: Improvement Half-Life for On-Time Delivery Percentage

AFFX: Chng_in_OTD(211) Industry_OTD_HalfLife(593)

UNITS: months

4.2 Product Development Time

The improvement process for the time required to develop breakthrough and line extension products is also represented using the same improvement model.

4.2.1 Breakthrough Products

The initial development time is set to thirty-six months based upon Analog's actual experience. The "erosion" time constant is assumed to be ten years. The improvement half-life is also thirty-six months. This is larger than the original twenty-four months estimated by Analog before they started the improvement process. However, since Analog's actual product time to market showed no improvement over the relevant time period, we assume a half-life that is longer, but still allows for significant improvement in product development time. The minimum development time is assumed to be twelve months, significantly less than has been achieved by Analog to date.

222: $Prd_Dvlp_Time_Brkth = Prd_Dvlp_Time_Brkth * (t-dt) + (Incr_in_PD_Time_Bkth - Decr_in_PD_Time_Brkth) * dt$
INIT: 36

DEFN: Development Time for Breakthrough Products
USES: $Decr_in_PD_Time_Brkth(224)$ $Incr_in_PD_Time_Bkth(223)$
AFFX: $Reported_PD_Time(49)$ $Time_for_Prd_Design_Bkth(51)$ $Time_thru_Wafer_Fab_Bkth(52)$
 $Time_to_Layout_Bkth(56)$ $Decr_in_PD_Time_Brkth(224)$ $Init_Prd_Dvl_Time_Bkth(237)$
 $Potential_PD_Time_Erosion_Bkth(257)$
UNITS: months

223: $Incr_in_PD_Time_Bkth = Potential_PD_Time_Erosion_Bkth / PD_Erosion_Time$

DEFN: Increase in the Development Time for Breakthrough Products
USES: $PD_Erosion_Time(252)$ $Potential_PD_Time_Erosion_Bkth(257)$
AFFX: $Prd_Dvlp_Time_Brkth(222)$
UNITS: months/month

257: $Potential_PD_Time_Erosion_Bkth = Init_Prd_Dvl_Time_Bkth - Prd_Dvlp_Time_Brkth$

DEFN: Potential Erosion in Development Time for Breakthrough Products
USES: $Init_Prd_Dvl_Time_Bkth(237)$ $Prd_Dvlp_Time_Brkth(222)$
AFFX: $Incr_in_PD_Time_Bkth(223)$
UNITS: months

252: $PD_Erosion_Time = 120$

DEFN: Average Time Required for Development Time to Erode to its Initial Value
AFFX: $Incr_in_PD_Time_Bkth(223)$ $Incr_in_PD_Time_Ext(226)$
UNITS: months

224: $Decr_in_PD_Time_Brkth = ((Prd_Dvlp_Time_Brkth - Min_Brkth_Dvlp_Time) / (Product_Development_Time_Half_Life / Ln2)) * TQM_Commitment_in_Product_Development$

DEFN: Decrease in the Development Time for Breakthrough Times
USES: $Ln2(241)$ $Min_Brkth_Dvlp_Time(247)$ $Prd_Dvlp_Time_Brkth(222)$
 $Product_Development_Time_Half_Life(263)$ $TQM_Commitment_in_Product_Development(273)$
AFFX: $Prd_Dvlp_Time_Brkth(222)$
UNITS: months/month

247: $\text{Min_Brkth_Dvlp_Time} = 12$

DEFN: Minimum Time for Developing Breakthrough Products
 AFFX: $\text{Decr_in_PD_Time_Brkth}(224)$
 UNITS: months

263: $\text{Product_Development_Time_Half_Life} = 36$

DEFN: Improvement Half-Life for Breakthrough Product Development Time
 AFFX: $\text{Desired_Imprv_Frac}(39)$ $\text{Decr_in_PD_Time_Brkth}(224)$ $\text{Decr_in_PD_Time_Ext}(227)$
 UNITS: months

237: $\text{Init_Prd_Dvl_Time_Bkth} = \text{INIT}(\text{Prd_Dvlp_Time_Brkth})$

DEFN: Initial Condition for Time Required to Develop Breakthrough Products
 USES: $\text{Prd_Dvlp_Time_Brkth}(222)$
 AFFX: $\text{Potential_PD_Time_Erosion_Bkth}(257)$
 UNITS: months

4.2.2 Line Extension Products

The initial development time for line extension products is assumed to be twenty-one months based upon data obtained through interviews with Analog product development staff [Kress 1992]. The "erosion" time constant is the same as for breakthrough products, as is the improvement half-life and the minimum product development time.

225: $\text{Prd_Dvlp_Time_Ext} = \text{Prd_Dvlp_Time_Ext} * (t-dt) + (\text{Incr_in_PD_Time_Ext} - \text{Decr_in_PD_Time_Ext}) * dt$
 INIT: 21

DEFN: Time Required to Develop Line Extension Products
 USES: $\text{Decr_in_PD_Time_Ext}(227)$ $\text{Incr_in_PD_Time_Ext}(226)$
 AFFX: $\text{Reported_PD_Time}(49)$ $\text{Time_Thru_Wafer_Fab_Ext}(53)$ $\text{Time_to_Design_Exts}(55)$
 $\text{Time_to_Layout_Ext}(57)$ $\text{Decr_in_PD_Time_Ext}(227)$ $\text{Init_Prd_Dvl_Time_Ext}(238)$
 $\text{Potential_PD_Time_Erosion_Ext}(258)$
 UNITS: months

226: $\text{Incr_in_PD_Time_Ext} = \text{Potential_PD_Time_Erosion_Ext} / \text{PD_Erosion_Time}$

DEFN: Increase in Time Required to Develop Line Extension Products
 USES: $\text{PD_Erosion_Time}(252)$ $\text{Potential_PD_Time_Erosion_Ext}(258)$
 AFFX: $\text{Prd_Dvlp_Time_Ext}(225)$
 UNITS: months/month

258: $\text{Potential_PD_Time_Erosion_Ext} = \text{Init_Prd_Dvl_Time_Ext} - \text{Prd_Dvlp_Time_Ext}$

DEFN: Potential Increase in Development Time Due to Erosion
 USES: $\text{Init_Prd_Dvl_Time_Ext}(238)$ $\text{Prd_Dvlp_Time_Ext}(225)$
 AFFX: $\text{Incr_in_PD_Time_Ext}(226)$
 UNITS: months

238: Init_Prd_Dvl_Time_Ext = INIT(Prd_Dvlp_Time_Ext)

DEFN: Initial Condition for Time Required to Develop Line Extension Products

USES: Prd_Dvlp_Time_Ext(225)

AFFX: Potential_PD_Time_Erosion_Ext(258)

UNITS: months

227: Decr_in_PD_Time_Ext = ((Prd_Dvlp_Time_Ext - Min_Ext_Prd_Dvlp_Time)/(Product_Development_Time_Half_Life/Ln2))*TQM_Commitment_in_Product_Development

DEFN: Decrease in Product Development Time for Line Extension

USES: Ln2(241) Min_Ext_Prd_Dvlp_Time(248) Prd_Dvlp_Time_Ext(225)

Product_Development_Time_Half_Life(263) TQM_Commitment_in_Product_Development(273)

AFFX: Prd_Dvlp_Time_Ext(225)

UNITS: months/month

248: Min_Ext_Prd_Dvlp_Time = 12

DEFN: Minimum Time to Develop Line Extension Products

AFFX: Decr_in_PD_Time_Ext(227)

UNITS: months

241: Ln2 = LOGN(2)

DEFN: Natural Log of Two

AFFX: Chng_in_OTD(211) Reduction_in_Cycle_Time(215) Reduction_In_Defects(218)

Increase_in_Yield(220) Decr_in_PD_Time_Brkh(224) Decr_in_PD_Time_Ext(227)

UNITS: dimensionless

4.3 Measuring Improvement Rates

For the purposes of allocating improvement effort and evaluating the overall success of the TQM program is important to calculate aggregate improvement rates for the two major sectors, manufacturing and product development.

4.3.1 Productivity Improvement

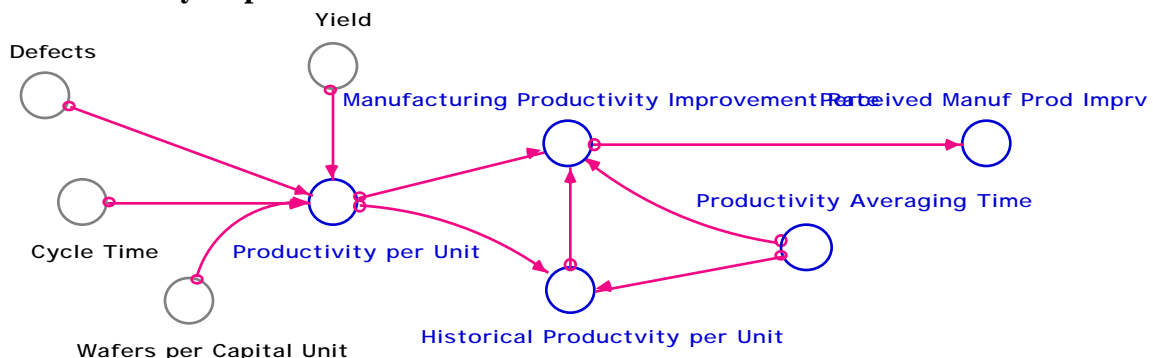

The measure of interest in the manufacturing area is assumed to be the improvement rate of unit capital productivity. Since the capital labor ratio is assumed to be constant it does not matter which productivity measure is chosen. The measured productivity per capital unit is equal to the

gross number of wafers that a capital unit can produce multiplied by the current manufacturing yield, divided by the current manufacturing cycle time, and multiplied by the fraction of outgoing product that are not defective. This measure gives the number of non-defective output units per month that a capital unit can produce.

$$262: \text{Productivity_per_Unit} = \text{Wafers_per_Capital_Unit} * (1 - (\text{Defects}/1\text{E}6)) * \text{Yield}/\text{Cycle_Time}$$

DEFN: Productivity Per Capital Unit

USES: Cycle_Time(228) Defects(231) Wafers_per_Capital_Unit(183) Yield(265)

AFFX: Historical_Productivity_per_Unit(235) Manufacturing_Productivity_Improvement_Rate(242)

UNITS: units/month

The historical or reference productivity rate is assumed to be a first order, exponentially, weighted average of the historical series. The time constant for this process is assumed to be twelve months. This time constant is longer than the three month time constant assumed in other places based upon a quarterly budgeting cycle. However, the components of productivity are, in Analog's experience, quite noisy. As a result a longer horizon is required to correctly discern underlying trends.

$$235: \text{Historical_Productivity_per_Unit} =$$

SMTH1(Productivity_per_Unit, Productivity_Averaging_Time, Productivity_per_Unit)

DEFN: Historical Productivity Per Capital Unit

USES: Productivity_Averaging_Time(261) Productivity_per_Unit(262)

AFFX: Manufacturing_Productivity_Improvement_Rate(242)

UNITS: units/month

$$261: \text{Productivity_Averaging_Time} = 12$$

DEFN: Average Time Required to Adjust to Changes in the Productivity Per Capital Unit

AFFX: Historical_Productivity_per_Unit(235) Manufacturing_Productivity_Improvement_Rate(242)

UNITS: months

The productivity improvement rates is calculated as the difference between the current and historical productivity divided by the historical productivity multiplied by the average time constant which yields a measure of percent change in productivity on a monthly basis.

$$242: \text{Manufacturing_Productivity_Improvement_Rate} = (\text{Productivity_per_Unit} - \text{Historical_Productivity_per_Unit}) / (\text{Historical_Productivity_per_Unit} * \text{Productivity_Averaging_Time})$$

DEFN: Manufacturing Productivity Improvement Rate

USES: Historical_Productivity_per_Unit(235) Productivity_Averaging_Time(261)

Productivity_per_Unit(262)

AFFX: Perceived_Manuf_Prod_Imprv_Rate(253) Ind_Change_in_Manuf_Comm_from_Results(295)

UNITS: 1/months

The productivity growth rate perceived by the organization is also assumed to be an exponentially weighted average of the historical value. The time constant here is assumed to be the normal three months.

253: Perceived_Manuf_Prod_Imprv_Rate =
SMTH1(Manufacturing_Productivity_Improvement_Rate,3,Manufacturing_Productivity_Improvement_Rate)

DEFN: Perceived Manufacturing Productivity Improvement Rate
USES: Manufacturing_Productivity_Improvement_Rate(242)
AFFX: Eff_of_Imprv_Ratio_on_Manuf_Attract(300)
UNITS: 1/months

4.3.2 Product Development Time

The reported product development time is assumed to be the measure of interest in the product development area. The reported product development time is a weighted average of the time required for developing breakthrough and line extension products and is calculated in the product development sector. The improvement rate is calculated in an identical manner to that of manufacturing.

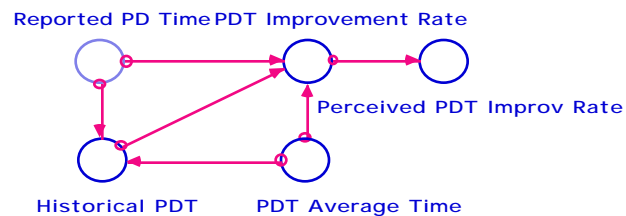

254: Perceived_PDT_Improv_Rate = smth1(PDT_Improvement_Rate,3,PDT_Improvement_Rate)

DEFN: Perceived Product Development Time Improvement Rate
USES: PDT_Improvement_Rate(251)
AFFX: Eff_of_Imprv_on_PDT_Attract(301)
UNITS: 1/months

251: PDT_Improvement_Rate = (Historical_PDT - Reported_PD_Time) / (Historical_PDT * PDT_Average_Time)

DEFN: Product Development Time Improvement Rate
USES: Historical_PDT(234) PDT_Average_Time(250) Reported_PD_Time(49)
AFFX: Perceived_PDT_Improv_Rate(254) Ind_Change_in_PD_Comm_from_Results(296)
UNITS: 1/months

234: Historical_PDT = SMTH1(Reported_PD_Time,PDT_Average_Time,Reported_PD_Time)

DEFN: Historical Product Development Time
USES: PDT_Average_Time(250) Reported_PD_Time(49)
AFFX: PDT_Improvement_Rate(251)
UNITS: months

250: PDT_Average_Time = 12

DEFN: Average Time Required to Adjust to Changes in the Product Deveopment Time
AFFX: Historical_PDT(234) PDT_Improvement_Rate(251)
UNITS: months

5. Diffusion of Skills and Commitment Dynamics

5.0 Overview

Commitment to and skillfull use of the appropriate tools are critical determinants of the success of any quality and productivity improvement program. The purpose of this sector is develop a model of these dynamics. The spread of skills and commitment is modeled as a diffusion process, and the allocation of resources to support that commitment is represented as a dynamic adjustment process with a multi-dimensional utility function and fixed resource constraint.

5.1 The Dynamics of Commitment

5.1.1 Commitment in Manufacturing

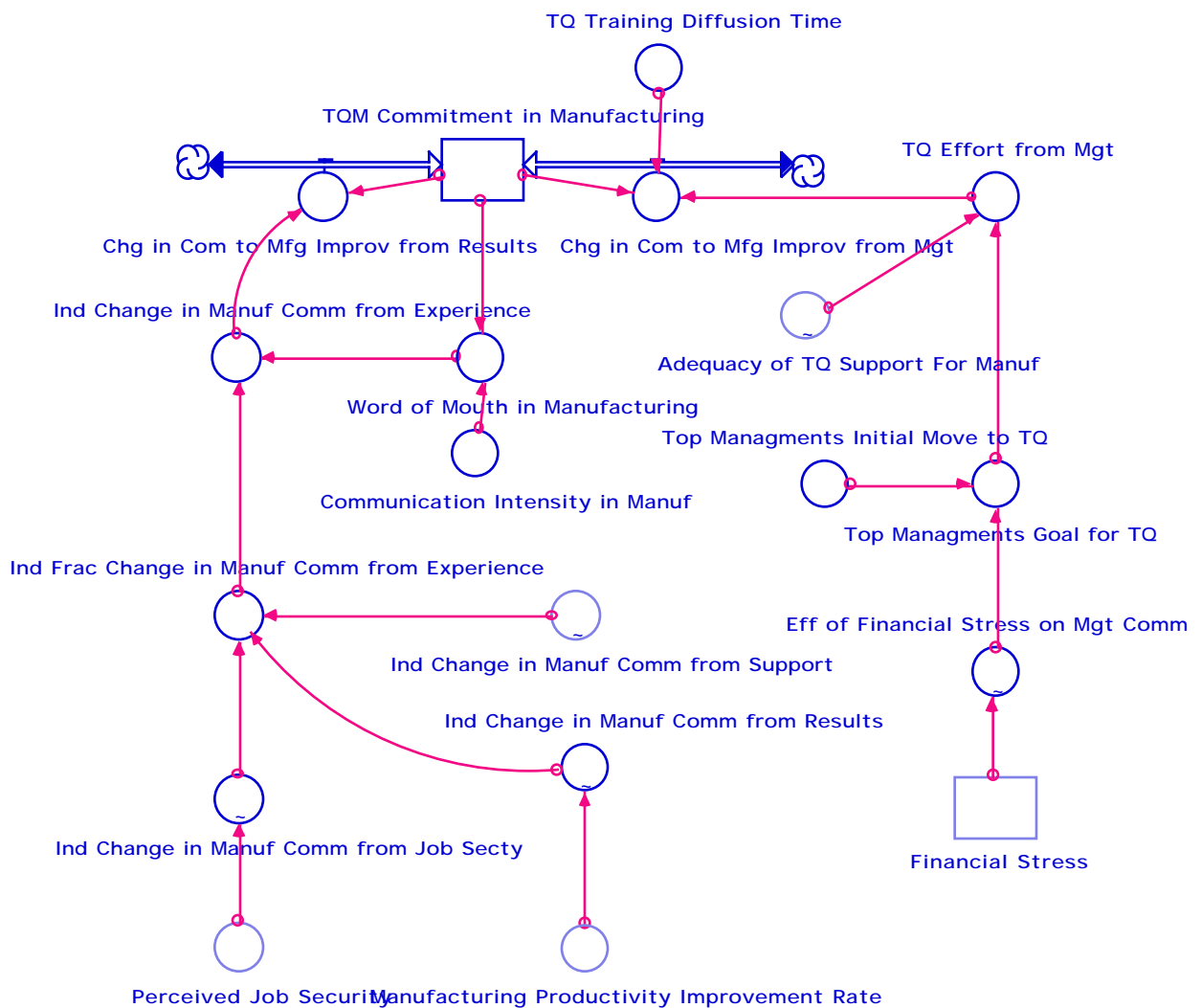

The construct Commitment to TQM, constrained to the zero-one interval, is defined as the percent of the workforce that is currently using TQM methods and tools at full capacity. Commitment is assumed to be zero at the beginning of the simulation. The change in the commitment level is decomposed into two separate effects, a "push" from management, and a "pull" from results [Shiba, Walden, and Graham 1993]. The "push" represents the effects of training programs and motivational presentations. This is modeled as a standard first order adjustment process. Management makes an initial move towards implementing TQM by setting a target commitment level. This is simply modeled as a step function which moves from a value of zero to one in the twenty-fourth month of simulation, approximately the time TQM was introduced at Analog [Schneiderman 1992a]. Top management's effective goal for commitment is equal to this initial target adjusted for the effects of financial stress. As financial stress becomes acute, management is assumed to spend less time and money supporting and motivating TQM, and, as result, the effective target falls. The effort that management applies to TQM is equal to management's effective goal for TQM multiplied by the adequacy of support in the manufacturing area. The adequacy of support is defined over the zero-one interval and is the ratio of resources allocated to support TQM in manufacturing divided by the resources required to support TQM in manufacturing. As support resource adequacy declines, management's effort is also assumed to fall, as there are fewer available channels through which top management can provide additional training and motivation to the workforce. Finally, absent "pull" effects, commitment is assumed to approach management's effort level with a first order delay. The delay represents the time required for top management to provided the training and motivation seminars to achieve the target commitment level. The time constant is assumed to be twelve months based upon data obtained from interviews with Analog management and quality personnel [Schneiderman 1992a, 1992b].

270: $TQM_Commitment_in_Manufacturing = TQM_Commitment_in_Manufacturing * (t-dt) + (Chg_in_Com_to_Mfg_Improv_from_Results + Chg_in_Com_to_Mfg_Improv_from_Mgt) * dt$
INIT: 0

DEFN: Commitment to TQM in Manufacturing

USES: Chg_in_Com_to_Mfg_Improv_from_Mgt(272) Chg_in_Com_to_Mfg_Improv_from_Results(271)

AFFX: Chng_in_OTD(211) Reduction_in_Cycle_Time(215) Reduction_In_Defects(218)

Increase_in_Yield(220) Chg_in_Com_to_Mfg_Improv_from_Results(271)

Chg_in_Com_to_Mfg_Improv_from_Mgt(272) Word_of_Mouth_in_Manufacturing(290)

Manuf_TQ_Support_Required(306)

UNITS: Dimensionless

272: $Chg_in_Com_to_Mfg_Improv_from_Mgt = (TQ_Effort_from_Mgt - TQM_Commitment_in_Manufacturing) / TQ_Training_Diffusion_Time$

DEFN: Change in the Commitment to TQM in Manufacturing Due to Management

USES: TQ_Effort_from_Mgt(287) TQ_Training_Diffusion_Time(289)

TQM_Commitment_in_Manufacturing(270)

AFFX: TQM_Commitment_in_Manufacturing(270)

UNITS: 1/months

286: $\text{Top_Managements_Initial_Move_to_TQ} = \text{STEP}(1,24)*1$

DEFN: Top Management's Initial Move to TQM
 AFFX: $\text{Top_Managements_Goal_for_TQ}(285)$
 UNITS: dimensionless

285: $\text{Top_Managements_Goal_for_TQ} =$
 $\text{Eff_of_Financial_Stress_on_Mgt_Comm} * \text{Top_Managements_Initial_Move_to_TQ}$

DEFN: Top Management's Goal for TQM Commitment
 USES: $\text{Eff_of_Financial_Stress_on_Mgt_Comm}(293)$ $\text{Top_Managements_Initial_Move_to_TQ}(286)$
 AFFX: $\text{TQ_Effort_from_Mgt}(287)$ $\text{TQ_Effort_PDT_from_Mgt}(288)$
 UNITS: dimensionless

287: $\text{TQ_Effort_from_Mgt} =$
 $\text{Top_Managements_Goal_for_TQ} * \text{SMTH1}(\text{Adequacy_of_TQ_Support_For_Manuf}, 3, 1)$

DEFN: Management's Effort Focused on Generating Commitment to TQM
 USES: $\text{Adequacy_of_TQ_Support_For_Manuf}(317)$ $\text{Top_Managements_Goal_for_TQ}(285)$
 AFFX: $\text{Chg_in_Com_to_Mfg_Improv_from_Mgt}(272)$
 UNITS: dimensionless

289: $\text{TQ_Training_Diffusion_Time} = 12$

DEFN: Average Time Required to Provide TQM Training
 AFFX: $\text{Chg_in_Com_to_Mfg_Improv_from_Mgt}(272)$ $\text{Chg_in_TQ_Com_to_PDT_from_Mgt}(275)$
 UNITS: months

The effect of financial stress on management's commitment to TQM is operationalized as a decreasing function with a second derivative that is initially positive and becomes negative at approximately the mid-point. Small levels of financial stress have little effect on management's commitment, but as financial stress grows, management becomes increasingly unwilling to allocate scarce resources to the quality effort. This phenomenon was identified through interviews with top management at Analog [Stata 1993].

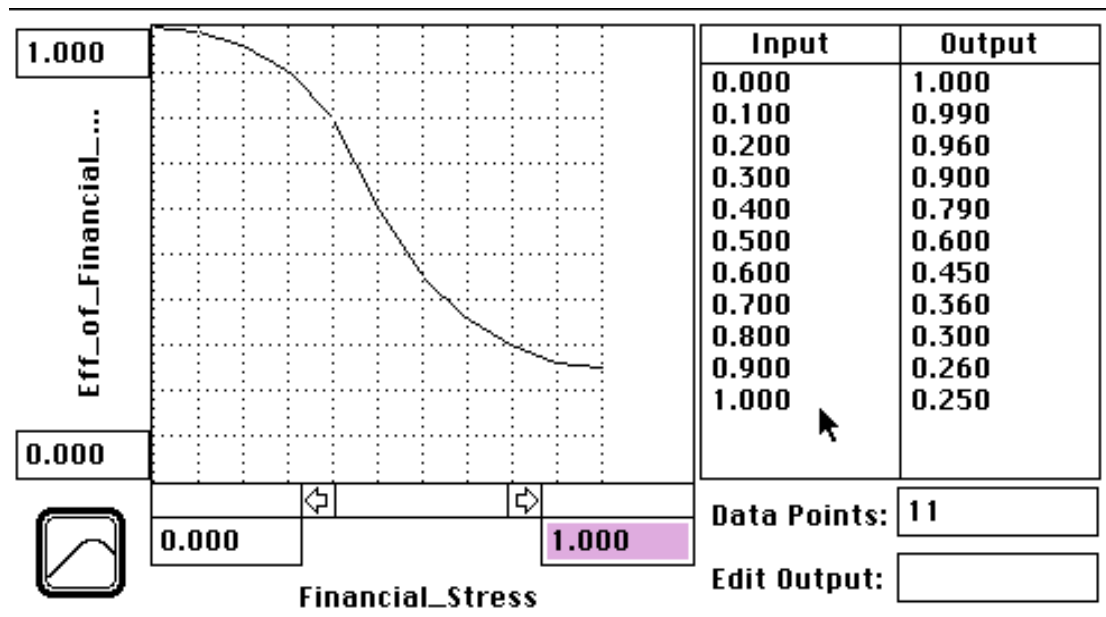

293: Eff_of_Financial_Stress_on_Mgt_Comm = GRAPH(Financial_Stress)
 DATA: (0.00, 1.00), (0.1, 0.99), (0.2, 0.96), (0.3, 0.9), (0.4, 0.79), (0.5, 0.6), (0.6, 0.45), (0.7, 0.36), (0.8, 0.3), (0.9, 0.26), (1, 0.25)

DEFN: The Effect of Financial Stress on Management's Commitment to TQM
 USES: Financial_Stress(552)
 AFFX: Top_Managements_Goal_for_TQ(285)
 UNITS: dimensionless

The "pull" effect, the change in commitment caused by results, is generated by a diffusion process. This model has been applied to a wide array of phenomena including awareness of new products and ideas [Paich and Sterman 1993, Homer 1987, Bass 1968]. The change in commitment from results is determined by the fraction of the workforce not yet committed and the experience of those that have already become committed. The indicated change in commitment from experience is a function of the strength of "word of mouth" in the manufacturing area and the opinion of those that have already used the techniques. "Word of mouth" represents the contacts between users and non-users of TQM and the strength of the communication that occurs during each of those contacts. It is assumed to be a function of the number of people that are already using TQM and the intensity of communication between users and non-users. The intensity of communication is assumed to be constant and set equal to one.

271: Chg_in_Com_to_Mfg_Improv_from_Results = (1 - TQM_Commitment_in_Manufacturing)*Ind_Change_in_Manuf_Comm_from_Experience

DEFN: Change in TQM Commitment in Manufacturing Due to Results
 USES: Ind_Change_in_Manuf_Comm_from_Experience(280)
 TQM_Commitment_in_Manufacturing(270)
 AFFX: TQM_Commitment_in_Manufacturing(270)
 UNITS: 1/months

280: $\text{Ind_Change_in_Manuf_Comm_from_Experience} = \text{Word_of_Mouth_in_Manufacturing} * \text{Ind_Frac_Change_in_Manuf_Comm_from_Experience}$

DEFN: Indicated Change in Manufacturing Commitment to TQM Resulting from Experience

USES: $\text{Ind_Frac_Change_in_Manuf_Comm_from_Experience}(281)$

$\text{Word_of_Mouth_in_Manufacturing}(290)$

AFFX: $\text{Chg_in_Com_to_Mfg_Improv_from_Results}(271)$

UNITS: 1/months

290: $\text{Word_of_Mouth_in_Manufacturing} =$

$\text{TQM_Commitment_in_Manufacturing} * \text{Communication_Intensity_in_Manuf}$

DEFN: Word of Mouth in Manufacturing

USES: $\text{Communication_Intensity_in_Manuf}(278)$ $\text{TQM_Commitment_in_Manufacturing}(270)$

AFFX: $\text{Ind_Change_in_Manuf_Comm_from_Experience}(280)$

UNITS: 1/months

278: $\text{Communication_Intensity_in_Manuf} = 1$

DEFN: Intensity of Communication in the Manufacturing Area

AFFX: $\text{Word_of_Mouth_in_Manufacturing}(290)$

UNITS: 1/months

Word of mouth can either be favorable or unfavorable depending on the experience of those that have used TQM. It is assumed to be determined by three factors; actual productivity experience, the adequacy of resources to support the quality effort, and perceived job security.

281: $\text{Ind_Frac_Change_in_Manuf_Comm_from_Experience} =$

$\text{Ind_Change_in_Manuf_Comm_from_Results} + \text{Ind_Change_in_Manuf_Comm_from_Support} + \text{Ind_Change_in_Manuf_Comm_from_Job_Secty}$

DEFN: Indicated Fractional Change in Commitment to TQM in Manufacturing Due to Experience

USES: $\text{Ind_Change_in_Manuf_Comm_from_Job_Secty}(294)$

$\text{Ind_Change_in_Manuf_Comm_from_Results}(295)$ $\text{Ind_Change_in_Manuf_Comm_from_Support}(319)$

AFFX: $\text{Ind_Change_in_Manuf_Comm_from_Experience}(280)$

The construct perceived job security is defined over the zero one interval and is discussed below. Its effect on the sign and strength of word of mouth is determined by an increasing, concave, function with a range of negative two to zero. The function is specified such that if job security declines significantly, this effect will dominate any positive effects of results or support. The function represents the assumed concern of the workforce that if job security is perceived to be low they will be reluctant to 'improve themselves out of a job'. If laborers believe that improvements in productivity will result in downsizing or lay-offs commitment to improvement will be reduced.

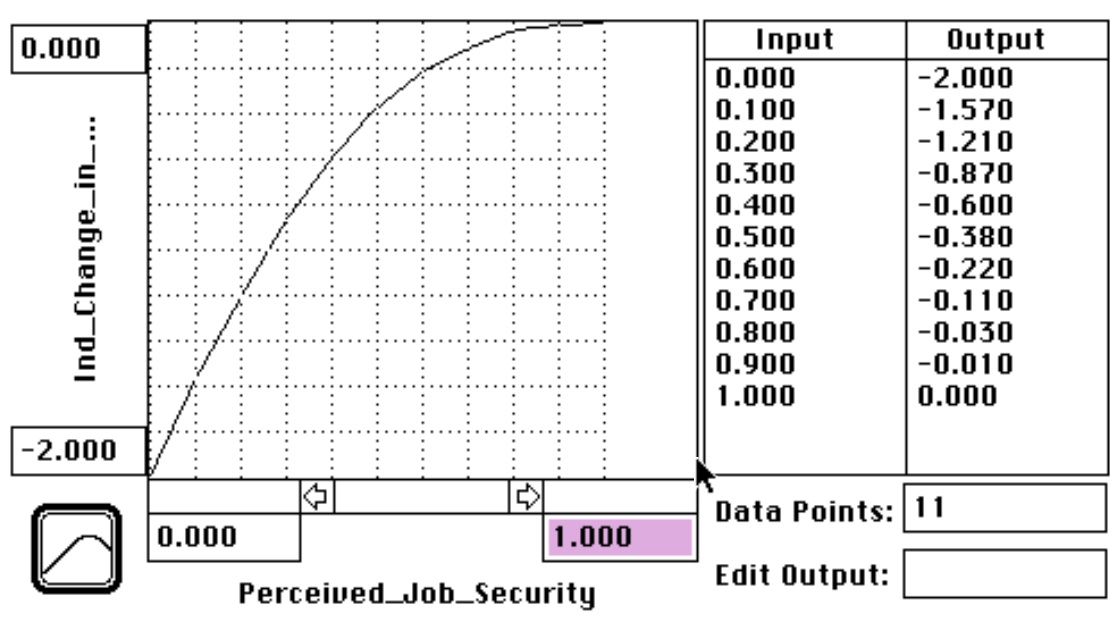

294: Ind_Change_in_Manuf_Comm_from_Job_Secty = GRAPH(Perceived_Job_Security)
 DATA: (0.00, -2.00), (0.1, -1.57), (0.2, -1.21), (0.3, -0.87), (0.4, -0.6), (0.5, -0.38), (0.6, -0.22), (0.7, -0.11), (0.8, -0.03), (0.9, -0.01), (1, 0.00)

DEFN: Indicated Change in Manufacturing Commitment to TQM Due to Perceived Job Security
 USES: Perceived_Job_Security(284)
 AFFX: Ind_Frac_Change_in_Manuf_Comm_from_Experience(281)
 UNITS: dimensionless

The effect of results on the sign and strength of word-of-mouth is determined by an increasing, non-linear function of the perceived change in manufacturing productivity. When the perceived improvement rate in productivity is in the neighborhood of zero, the function returns a value of -.25. As the improvement rate moves significantly above or below zero the function becomes S-shaped with limits at -.5 and .5 respectively.

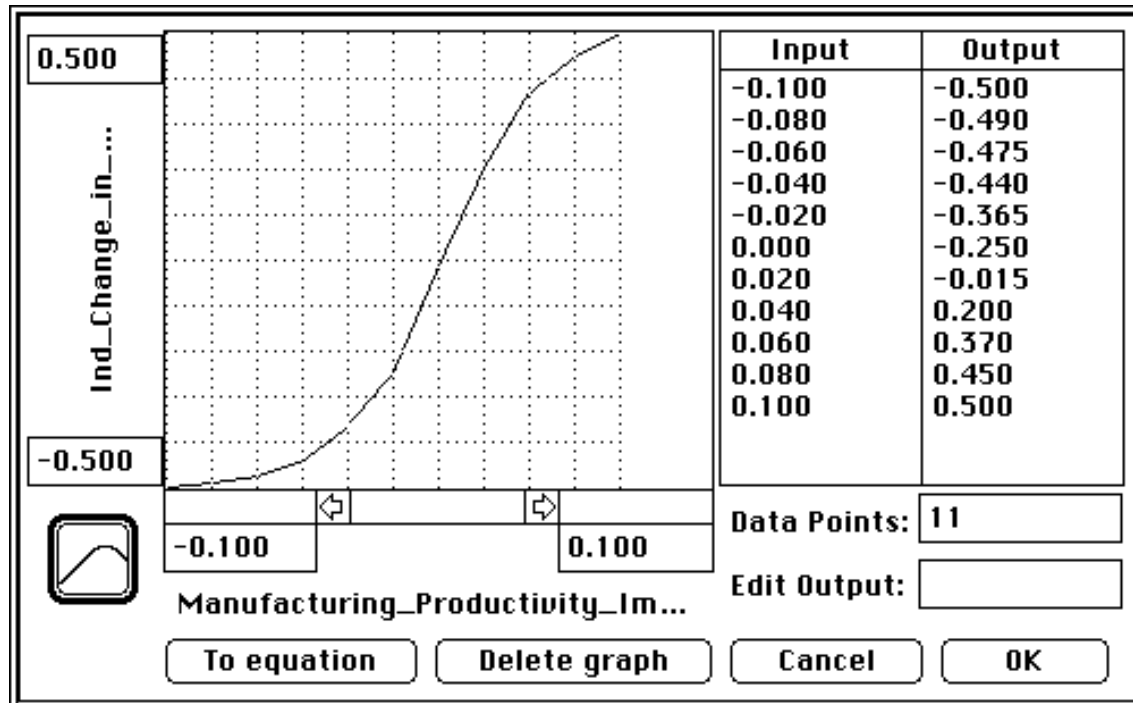

295: Ind_Change_in_Manuf_Comm_from_Results =
 GRAPH(Manufacturing_Productivity_Improvement_Rate)
 DATA: (-0.1, -0.5), (-0.08, -0.49), (-0.06, -0.475), (-0.04, -0.44), (-0.02, -0.365), (0.00, -0.125), (0.02, 0.0175), (0.04, 0.2), (0.06, 0.37), (0.08, 0.45), (0.1, 0.5)

DEFN: Indicated Change in Commitment to TQM in Manufacturing Due to Results
 USES: Manufacturing_Productivity_Improvement_Rate(242)
 AFFX: Ind_Frac_Change_in_Manuf_Comm_from_Experience(281)
 UNITS: dimensionless

The final determinant of the sign and strength of word of mouth is the current adequacy of resources to support the quality effort. The adequacy of resources is defined as the ratio of support resources allocated to support resources required. The effect of this ratio on the sign and strength of word of mouth is increasing and concave. At a ratio of one, the contribution is zero. As the ratio increase above one, more resources allocated than required, the contribution becomes positive but grows very slowly. However, as the ratio falls below one, more resources required than allocated, the contribution is negative and decreases quickly. Low levels of resource adequacy dominate any positive effect from results.

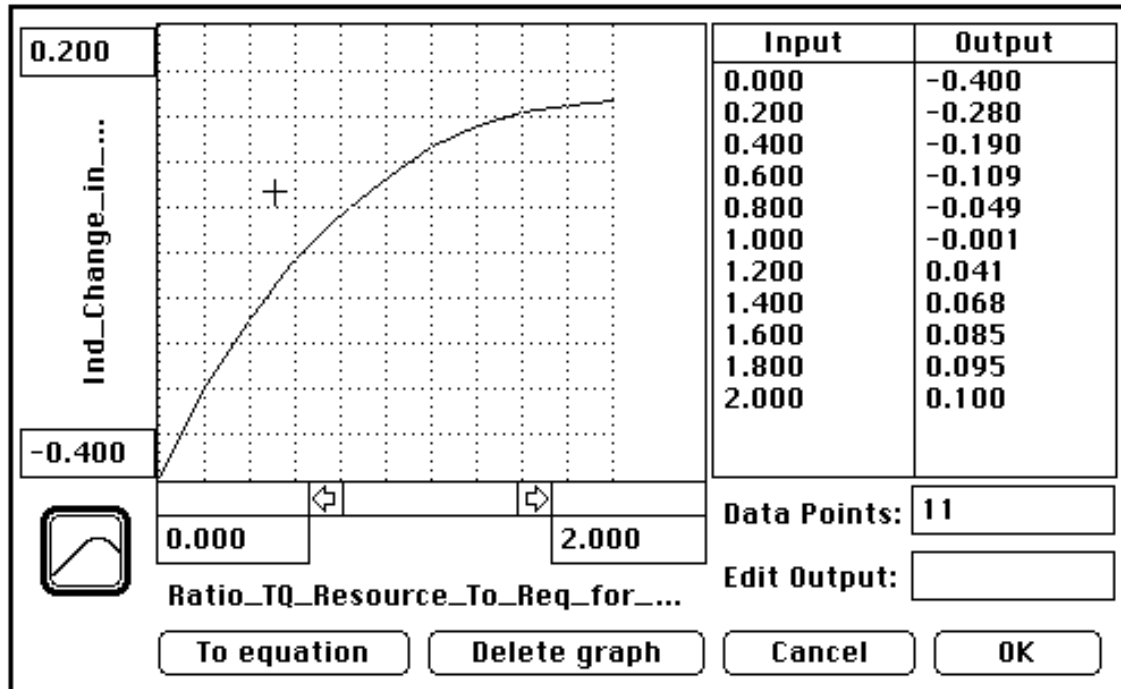

319: Ind_Change_in_Manuf_Comm_from_Support =
 GRAPH(Ratio_TQ_Resource_To_Req_for_Manuf)
 DATA: (0.00, -0.4), (0.2, -0.28), (0.4, -0.19), (0.6, -0.1), (0.8, -0.05), (1, 0.00), (1.20, 0.034), (1.40, 0.0628), (1.60, 0.0825), (1.80, 0.095), (2.00, 0.1)

DEFN: Indicated Change in Commitment to Manufacturing Due to Support
 USES: Ratio_TQ_Resource_To_Req_for_Manuf(309)
 AFFX: Ind_Frac_Change_in_Manuf_Comm_from_Experience(281)

5.1.2 Commitment in Product Development

The dynamics of commitment are similarly modeled in the product development area. Management's effort to promote TQM in product development is a function of their goal for TQ commitment, discussed in the previous sub-section, and the adequacy of the support resources allocated to the product development area. Absent 'pull' effects, commitment in the product development area approaches management's goal via a first order delay with a time constant of twelve months. Again the delay represents the time required for management to train the workforce in the use of the appropriate methods. The 'push' effects are determined by a diffusion process. The only difference in this case is that commitment is not affected by job security as it is assumed that product development staff are never laid off. This assumption is based upon the actual experience of Analog [Kress 1992].

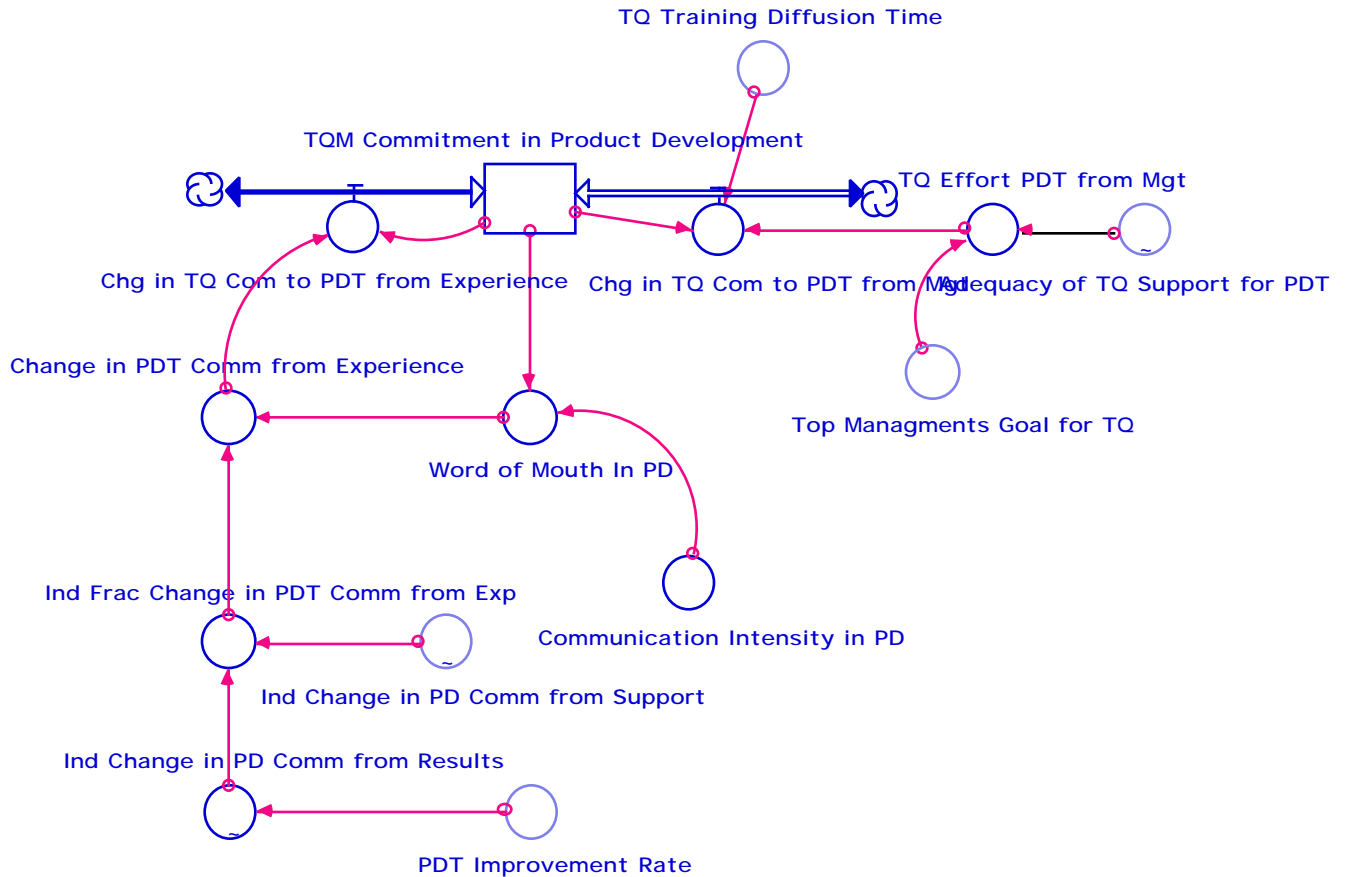

273: $TQM_Commitment_in_Product_Development = TQM_Commitment_in_Product_Development + (Chg_in_TQ_Com_to_PDT_from_Experience + Chg_in_TQ_Com_to_PDT_from_Mgt) * dt$
 INIT: 0

DEFN: Commitment to TQM in Product Development
 USES: Chg_in_TQ_Com_to_PDT_from_Experience(274) Chg_in_TQ_Com_to_PDT_from_Mgt(275)
 AFFX: Effect_of_TQM_on_Dvlp_Capacity(16) Decr_in_PD_Time_Brkth(224)
 Decr_in_PD_Time_Ext(227) Chg_in_TQ_Com_to_PDT_from_Experience(274)
 Chg_in_TQ_Com_to_PDT_from_Mgt(275) Word_of_Mouth_In_PD(291)
 PDT_TQ_Support_Required(307)
 UNITS: dimensionless

275: $Chg_in_TQ_Com_to_PDT_from_Mgt = (TQ_Effort_PDT_from_Mgt - TQM_Commitment_in_Product_Development) / TQ_Training_Diffusion_Time$

DEFN: Change in the Commitment to TQM in Product Development Due to Management
 USES: TQ_Effort_PDT_from_Mgt(288) TQ_Training_Diffusion_Time(289)
 TQM_Commitment_in_Product_Development(273)
 AFFX: TQM_Commitment_in_Product_Development(273)
 UNITS: 1/months

288: $TQ_Effort_PDT_from_Mgt = SMTH1(Adequacy_of_TQ_Support_for_PDT, 3, 1) * Top_Managements_Goal_for_TQ$

DEFN: TQM Effort in Product Development from Management
 USES: Adequacy_of_TQ_Support_for_PDT(318) Top_Managements_Goal_for_TQ(285)
 AFFX: Goal_Adjust(24) Frac_Bdgt_for_Bkth(61) Chg_in_TQ_Com_to_PDT_from_Mgt(275)
 UNITS: dimensionless

274: $\text{Chg_in_TQ_Com_to_PDT_from_Experience} = \text{Change_in_PDT_Comm_from_Experience} * (1 - \text{TQM_Commitment_in_Product_Development})$

DEFN: Change in Commitment to TQM in Product Development Due to the Staff's Experience

USES: $\text{Change_in_PDT_Comm_from_Experience}(277)$

$\text{TQM_Commitment_in_Product_Development}(273)$

AFFX: $\text{TQM_Commitment_in_Product_Development}(273)$

UNITS: 1/months

291: $\text{Word_of_Mouth_In_PD} =$

$\text{Communication_Intensity_in_PD} * \text{TQM_Commitment_in_Product_Development}$

DEFN: Word of Mouth in Product Development

USES: $\text{Communication_Intensity_in_PD}(279)$ $\text{TQM_Commitment_in_Product_Development}(273)$

AFFX: $\text{Change_in_PDT_Comm_from_Experience}(277)$

UNITS: 1/months

279: $\text{Communication_Intensity_in_PD} = 1$

DEFN: Intensity of Communication in the Product Development Area

AFFX: $\text{Word_of_Mouth_In_PD}(291)$

UNITS: 1/months

277: $\text{Change_in_PDT_Comm_from_Experience} =$

$\text{Ind_Frac_Change_in_PDT_Comm_from_Exp} * \text{Word_of_Mouth_In_PD}$

DEFN: Change in Commitment to TQM in Product Development Due to Experience

USES: $\text{Ind_Frac_Change_in_PDT_Comm_from_Exp}(282)$ $\text{Word_of_Mouth_In_PD}(291)$

AFFX: $\text{Chg_in_TQ_Com_to_PDT_from_Experience}(274)$

UNITS: 1/months

282: $\text{Ind_Frac_Change_in_PDT_Comm_from_Exp} =$

$\text{Ind_Change_in_PD_Comm_from_Results} + \text{Ind_Change_in_PD_Comm_from_Support}$

DEFN: Indicated Fractional Change in Commitment to TQM in Product Development Due to Experience

USES: $\text{Ind_Change_in_PD_Comm_from_Results}(296)$ $\text{Ind_Change_in_PD_Comm_from_Support}(320)$

AFFX: $\text{Change_in_PDT_Comm_from_Experience}(277)$

UNITS: 1/months

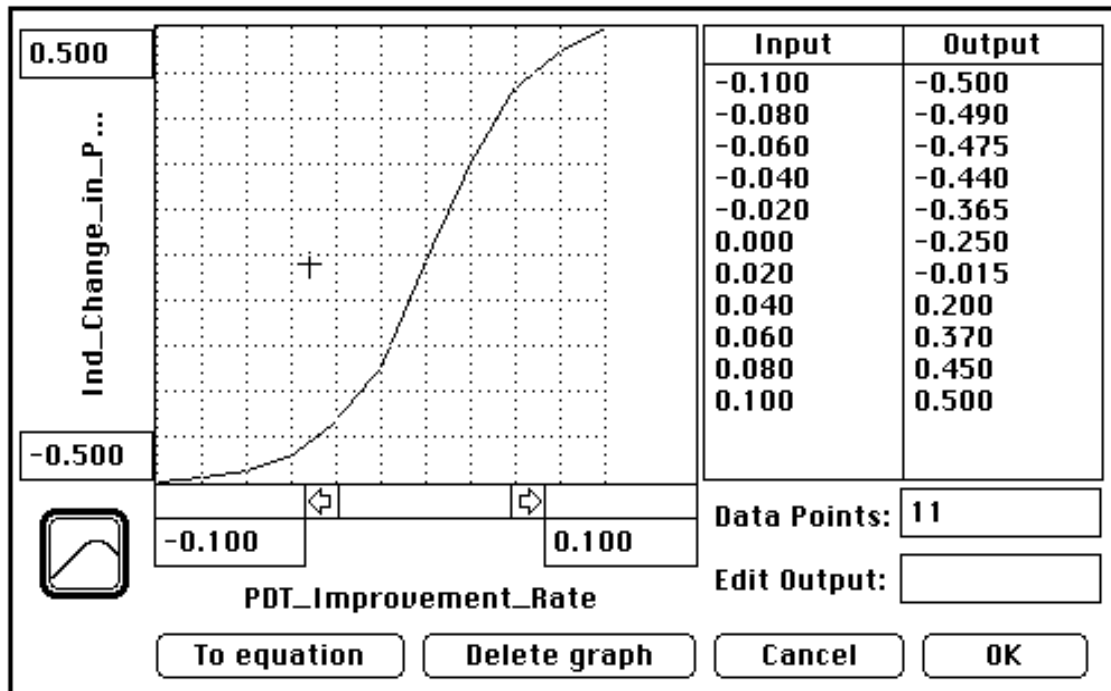

296: Ind_Change_in_PD_Comm_from_Results = GRAPH(PDT_Improvement_Rate)
 DATA: (-0.1, -0.5), (-0.08, -0.49), (-0.06, -0.475), (-0.04, -0.44), (-0.02, -0.365), (0.00, -0.25), (0.02, 0.015), (0.04, 0.2), (0.06, 0.37), (0.08, 0.45), (0.1, 0.5)

DEFN: Indicated Change in Commitment to TQM in Product Development Due to Results
 USES: PDT_Improvement_Rate(251)
 AFFX: Ind_Frac_Change_in_PDT_Comm_from_Exp(282)
 UNITS: 1/months

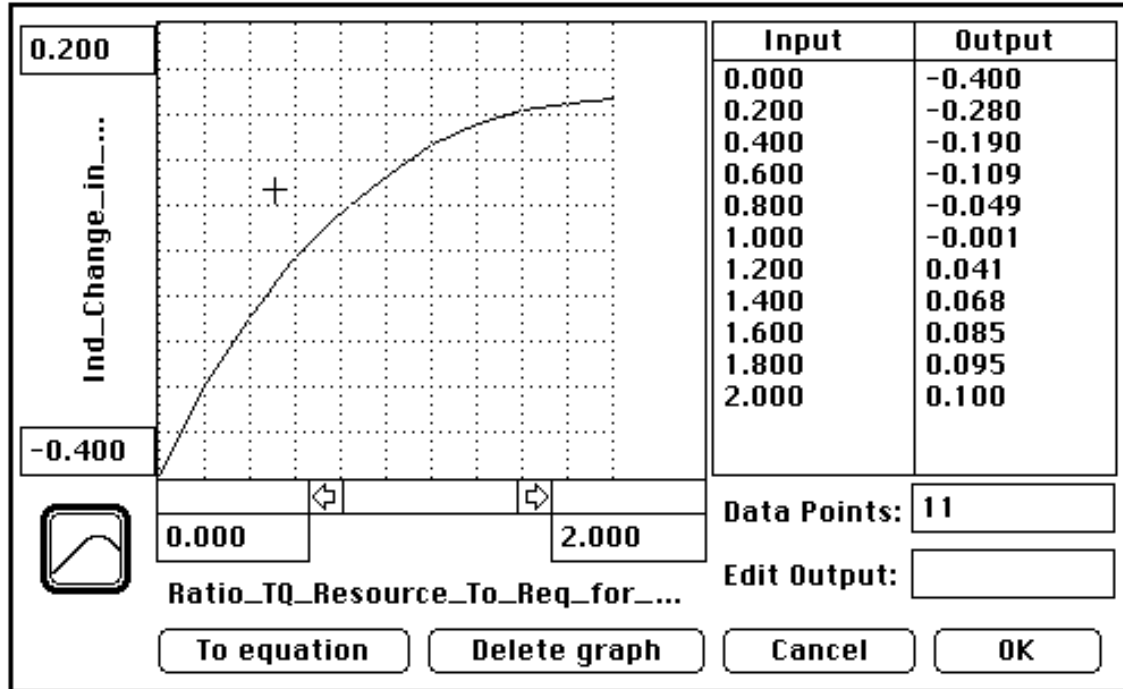

320: Ind_Change_in_PD_Comm_from_Support = GRAPH(Ratio_TQ_Resources_to_Req_for_PDT)
 DATA: (0.00, -0.4), (0.2, -0.28), (0.4, -0.19), (0.6, -0.1), (0.8, -0.05), (1, 0.00), (1.20, 0.034), (1.40, 0.0628), (1.60, 0.0825), (1.80, 0.095), (2.00, 0.1)

DEFN: Indicated Change in Commitment to TQM in Product Development Due to Support
 USES: Ratio_TQ_Resources_to_Req_for_PDT(308)
 AFFX: Ind_Frac_Change_in_PDT_Comm_from_Exp(282)
 UNITS: 1/months

5.2 Job Security

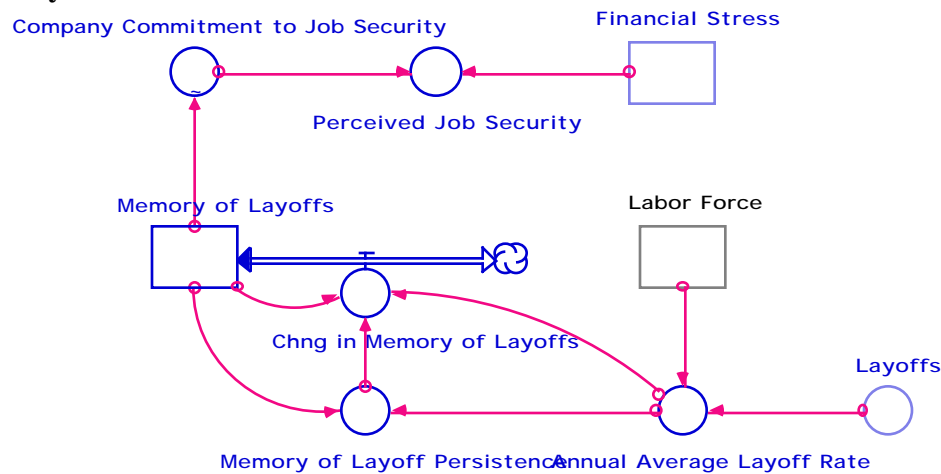

As previously mentioned the workforce's perceived job security is an important determinant of commitment to the improvement effort [Palmer 1993 Schneiderman 1992]. This sub-section describes a model of job security that is based upon two elements: the perceived financial health of the company and the workforce's memory of past lay-offs. The construct perceived job security is defined over the zero-one interval with a value of 1 indicating that the workforce has complete confidence that there will be no future lay-offs and 0 indicating that the workforce believes future lay-offs are assured. Perceived job security is assumed to be a first order exponentially weighted average of the maximum of the quantity one minus the level of financial stress and another variable defined over the zero one interval, the company's commitment to job security. Financial stress, which will be discussed in detail in a subsequent section, ranges from zero to one and represents the willingness of the firm to sacrifice long term objectives for short term gains in profitability. The workforce's perception of the company's commitment to no lay-offs is assumed to be a function of the workforce's memory of past lay-offs. The workforce "remembers" the annual lay-off rate and if this exceeds a critical threshold the company's commitment to job security is deemed to be low.

284: Perceived_Job_Security = MAX(SMTH1(1-Financial_Stress,6),Company_Commitment_to_Job_Security)

DEFN: Perceived Job Security

USES: Company_Commitment_to_Job_Security(292) Financial_Stress(552)

AFFX: Ind_Change_in_Manuf_Comm_from_Job_Secty(294)

UNITS: dimensionless

The workforce's memory of lay-offs is determined using a non-linear memory structure. The input to this structure, the annual average lay-off rate, is calculated as a weighted average of the number of people laid-off in previous twelve month period divided by the current labor force.

This input affects two variables, the change in the memory of lay-offs, the flow variable, and the persistence of the memory of layoffs, the time constant. If the current lay-off percentage is greater than the memory of lay-offs, then the memory is updated very quickly, a time constant of one month. If the current lay-off percentage is less than the current "memory", then the memory is updated very slowly with a time constant of ninety months. The result of this formulation is the management can only develop the reputation for being committed to job security by not laying off workers for a long period of time, while they can lose that reputation very quickly with one significant firing.

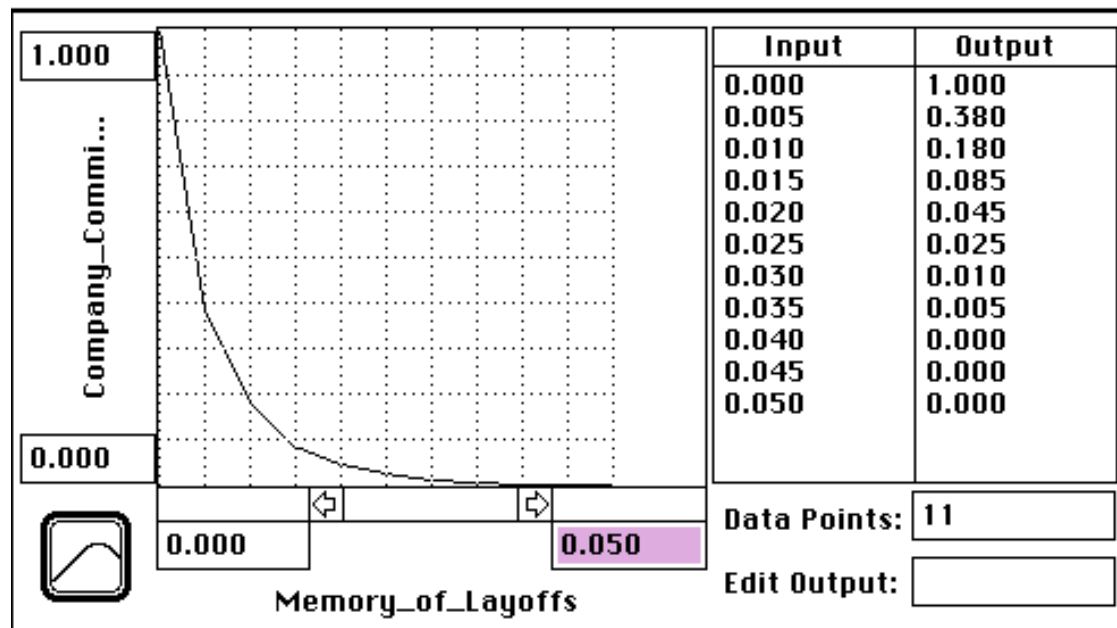

292: Company_Commitment_to_Job_Security = GRAPH(Memory_of_Layoffs)
 DATA: (0.00, 1.00), (0.005, 0.38), (0.01, 0.18), (0.015, 0.085), (0.02, 0.045), (0.025, 0.025), (0.03, 0.01), (0.035, 0.005), (0.04, 0.00), (0.045, 0.00), (0.05, 0.00)

DEFN: The Company's Perceived Commitment to Job Security
 USES: Memory_of_Layoffs(268)
 AFFX: Perceived_Job_Security(284)
 UNITS: dimensionless

268: Memory_of_Layoffs = Memory_of_Layoffs *(t-dt) + (- Chng_in_Memory_of_Layoffs) * dt
 INIT: 0

DEFN: The Workforce's Memory of Lay-offs
 USES: Chng_in_Memory_of_Layoffs(269)
 AFFX: Chng_in_Memory_of_Layoffs(269) Memory_of_Layoff_Persistence(283)
 Company_Commitment_to_Job_Security(292)
 UNITS: 1/months

269: Chng_in_Memory_of_Layoffs = (Memory_of_Layoffs-
 Annual_Average_Layoff_Rate)/Memory_of_Layoff_Persistence

DEFN: Change in the Workforce's Memory of Lay-offs

USES: Annual_Average_Layoff_Rate(276) Memory_of_Layoff_Persistence(283)

Memory_of_Layoffs(268)

AFFX: Memory_of_Layoffs(268)

UNITS: 1/months/month

283: Memory_of_Layoff_Persistence = if Annual_Average_Layoff_Rate > Memory_of_Layoffs then 1
else 90

DEFN: The Persistence of the Current Memory of Lay-Offs

USES: Annual_Average_Layoff_Rate(276) Memory_of_Layoffs(268)

AFFX: Chng_in_Memory_of_Layoffs(269)

UNITS: months

276: Annual_Average_Layoff_Rate = SMTH1(Layoffs,12)/Labor_Force

DEFN: Annual Average Rate of Lay-Offs

USES: Labor_Force(200) Layoffs(203)

AFFX: Chng_in_Memory_of_Layoffs(269) Memory_of_Layoff_Persistence(283)

UNITS: 1/months

5.3 Resource Allocation and Adequacy

The adequacy of resources to support the improvement effort is an important determinant of commitment to TQM. Throughout the model the level of total resources allocated by top management to support the TQM effort is assumed to be fixed. The resources available are assumed to be two hundred and forty full-time equivalent hours per month. This corresponds to one person, the Vice-President for Quality, working full time, and one assistant who also works full time but is only one half as effective as her superior.

297: TQM_Support_Resources = 240

DEFN: Resources Available to Support the TQM Effort

AFFX: Ratio_TQ_Resources_to_Req_for_PDT(308) Ratio_TQ_Resource_To_Req_for_Manuf(309)

Total_Adequacy_of_TQ_Support_Resources(313)

UNITS: hours/month

5.3.1 Manufacturing's Resource Requirement and Adequacy

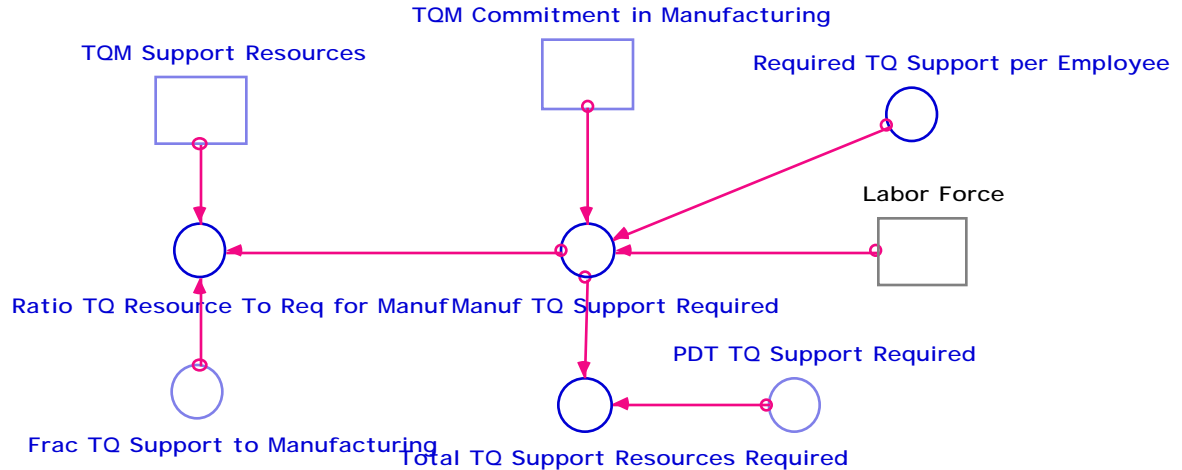

The resource requirement in the manufacturing area is equal to the number of people in the area multiplied by the resource requirement per person multiplied by the current level of commitment in manufacturing. Workers are assumed to be in teams of ten, with each team requiring one hour of support each month. The amount of resources actually allocated to manufacturing is equal to the fraction of resources allocated to the area, discussed in the following section, multiplied by the resource constraint. The of ratio resources available to those required is calculated by dividing the resources allocated by the resources required.

306: $\text{Manuf_TQ_Support_Required} = \text{TQM_Commitment_in_Manufacturing} * \text{Required_TQ_Support_per_Employee} * \text{Labor_Force} + .00001$

DEFN: TQM Support Required in Manufacturing

USES: Labor_Force(200) Required_TQ_Support_per_Employee(310)

TQM_Commitment_in_Manufacturing(270)

AFFX: Ind_Frac_TQ_Support_to_Manuf(304) Ratio_TQ_Resource_To_Req_for_Manuf(309)

Total_TQ_Support_Required(315) Total_TQ_Support_Resources_Required(316)

UNITS: hours/month

310: $\text{Required_TQ_Support_per_Employee} = .1$

DEFN: Required TQM Support per Employee in the Manufacturing Area

AFFX: Manuf_TQ_Support_Required(306)

UNITS: hours/employee/month

309: $\text{Ratio_TQ_Resource_To_Req_for_Manuf} =$

$(\text{TQM_Support_Resources} * \text{Frac_TQ_Support_to_Manufacturing}) / (\text{Manuf_TQ_Support_Required} + 1e-9)$

DEFN: Ratio of TQM Support Resource Required to TQM Support Resources Allocated

USES: Frac_TQ_Support_to_Manufacturing(302) Manuf_TQ_Support_Required(306)

TQM_Support_Resources(297)

AFFX: Adequacy_of_TQ_Support_For_Manuf(317) Ind_Change_in_Manuf_Comm_from_Support(319)

UNITS: dimensionless

5.3.2 Product Development's Resource Requirements and Adequacy

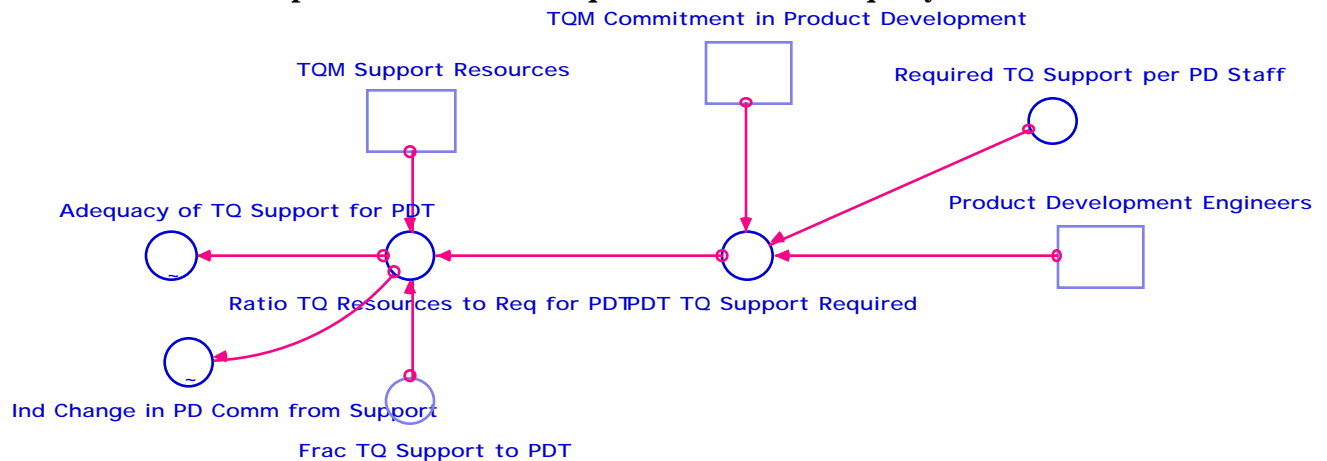

The improvement resource requirement in product development is similarly determined. Each product development engineer is assumed to require two and one half hours of support each month. This is substantially more than the requirement of manufacturing labor. This is due to inherent complexity of the PD engineer's task and the fact that work teams are likely to be much smaller, so support personnel can not work with as many people at any one time.

307: $PDT_TQ_Support_Required = Required_TQ_Support_per_PD_Staff * Product_Development_Engineers * TQM_Commitment_in_Product_Development + .00001$

DEFN: TQM Support Required in the Product Development Area
 USES: Product_Development_Engineers(3) Required_TQ_Support_per_PD_Staff(311)
 TQM_Commitment_in_Product_Development(273)
 AFFX: Ind_Frac_TQ_Support_to_PDT(305) Ratio_TQ_Resources_to_Req_for_PDT(308)
 Total_TQ_Support_Required(315) Total_TQ_Support_Resources_Required(316)
 UNITS: hours/month

311: $Required_TQ_Support_per_PD_Staff = 2.5$

DEFN: Required TQM Support per Product Development Engineer
 AFFX: PDT_TQ_Support_Required(307)
 UNITS: hours/employee/month

308: $Ratio_TQ_Resources_to_Req_for_PDT = (TQM_Support_Resources * Frac_TQ_Support_to_PDT) / (PDT_TQ_Support_Required + 1e-9)$

DEFN: Ratio Support Allocated to Support Required
 USES: Frac_TQ_Support_to_PDT(303) PDT_TQ_Support_Required(307)
 TQM_Support_Resources(297)
 AFFX: Adequacy_of_TQ_Support_for_PDT(318) Ind_Change_in_PD_Comm_from_Support(320)
 UNITS: dimensionless

313: $Total_Adequacy_of_TQ_Support_Resources = TQM_Support_Resources / (Total_TQ_Support_Required + .001)$

DEFN: Total Adequacy of TQ Support Resources
 USES: Total_TQ_Support_Required(314) TQM_Support_Resources(297)

UNITS: dimensionless

5.4 Support Resource Allocation

If the fixed resource constraint is not sufficient to support all the improvement effort then the allocation of those resources begins to play an important role in the dynamics of commitment and the resulting improvement rates. In this section of model it is assumed that there is a central staff responsible for supporting TQM in the various areas of the firm. Under the condition of scarcity, the members of this staff must decide where to allocate their efforts. They are assumed to use two pieces of information to make this decision: the resource requirements in each area, and the improvement rate in each area.

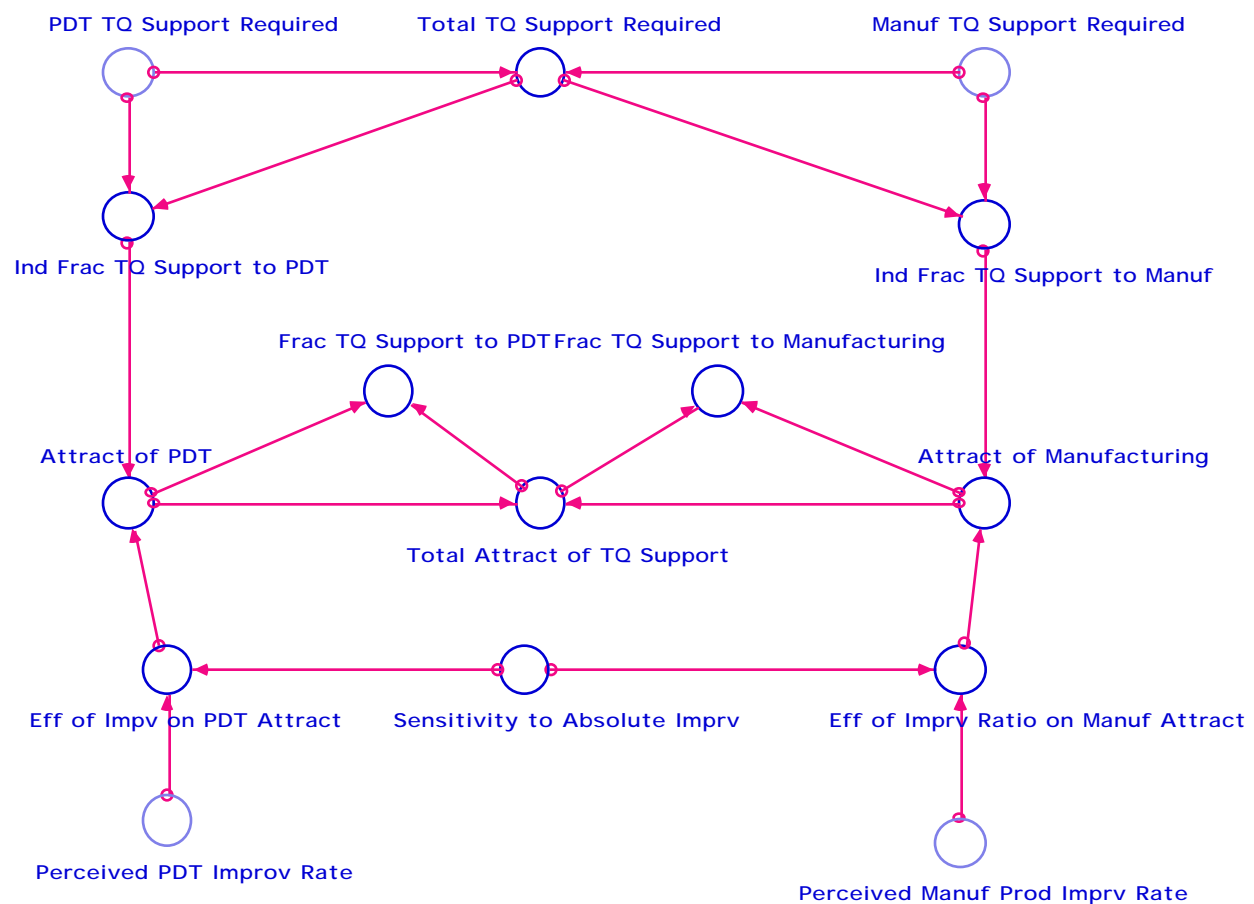

The indicated fraction of support allocated to each area is determined by calculating the resource requirement in each area as a percentage of the total resource requirement.

$$315: \text{Total_TQ_Support_Required} = \text{Manuf_TQ_Support_Required} + \text{PDT_TQ_Support_Required}$$

DEFN: Total TQM Support Required

USES: Manuf_TQ_Support_Required(306) PDT_TQ_Support_Required(307)

AFFX: Ind_Frac_TQ_Support_to_Manuf(304) Ind_Frac_TQ_Support_to_PDT(305)
 Total_Adequacy_of_TQ_Support_Resources(313)
 UNITS: hours/month

304: $\text{Ind_Frac_TQ_Support_to_Manuf} = \text{Manuf_TQ_Support_Required} / (\text{Total_TQ_Support_Required})$

DEFN: Indicated Fraction of Support to be Allcoate to Manufacturing
 USES: Manuf_TQ_Support_Required(306) Total_TQ_Support_Required(315)
 AFFX: Attract_of_Manufacturing(298)
 UNITS: dimensionless

305: $\text{Ind_Frac_TQ_Support_to_PDT} = \text{PDT_TQ_Support_Required} / (\text{Total_TQ_Support_Required})$

DEFN: Indicated Fraction of TQM Support to be Allocated to Product Development
 USES: PDT_TQ_Support_Required(307) Total_TQ_Support_Required(315)
 AFFX: Attract_of_PDT(299)
 UNITS: dimensionless

The indicated fraction of support for each area then becomes one of two elements in each area's attractiveness function. The second element is the measured improvement rate in each area raised to a power. If the exponent is positive, this indicates a policy of giving more resources to areas with faster improvement rates, while if the exponent is negative areas with slower improvement rates are given more resources. For this model the exponent is assumed to be positive and large, fifteen, to represent the policy of allocating more effort to the areas with better improvement rates. This corresponds to a policy widely recommended by TQM advocates, and originally used by Analog, of initially focusing on areas which are easy to improve so as to quickly demonstrate the feasibility and usefulness of the approach [Bluestone, B. and I. Bluestone 1992, Schneiderman 1992a, Schaffer, R. and H. Thomson 1992].

The total attractiveness of each area is then the product of the indicated fraction of resource requirements multiplied by the weighted improvement rate. The fraction of resources actually allocated to each area is then determined by calculating the area's attractiveness as a fraction of the total attractiveness of the two areas.

298: $\text{Attract_of_Manufacturing} = \text{Eff_of_Imprv_Ratio_on_Manuf_Attract} * \text{Ind_Frac_TQ_Support_to_Manuf}$

DEFN: Attractiveness of Manufacturing
 USES: Eff_of_Imprv_Ratio_on_Manuf_Attract(300) Ind_Frac_TQ_Support_to_Manuf(304)
 AFFX: Frac_TQ_Support_to_Manufacturing(302) Total_Attract_of_TQ_Support(314)
 UNITS: dimensionless

300: $\text{Eff_of_Imprv_Ratio_on_Manuf_Attract} = (\text{Perceived_Manuf_Prod_Imprv_Rate} + 1)^{\text{Sensitivity_to_Absolute_Imprv}}$

DEFN: Effect of the Improvement Rate on Manufacturing
 USES: Perceived_Manuf_Prod_Imprv_Rate(253) Sensitivity_to_Absolute_Imprv(312)
 AFFX: Attract_of_Manufacturing(298)
 UNITS: dimensionless

299: $\text{Attract_of_PDT} = \text{Eff_of_Impv_on_PDT_Attract} * \text{Ind_Frac_TQ_Support_to_PDT}$

DEFN: Attractiveness of the Product Development Area

USES: $\text{Eff_of_Impv_on_PDT_Attract}(301)$ $\text{Ind_Frac_TQ_Support_to_PDT}(305)$

AFFX: $\text{Frac_TQ_Support_to_PDT}(303)$ $\text{Total_Attract_of_TQ_Support}(314)$

UNITS: dimensionless

301: $\text{Eff_of_Impv_on_PDT_Attract} = (\text{Perceived_PDT_Improv_Rate} + 1)^{\text{Sensitivity_to_Absolute_Imprv}}$

DEFN: Effect of the Improvement Rate on the Attractiveness of Product Development

USES: $\text{Perceived_PDT_Improv_Rate}(254)$ $\text{Sensitivity_to_Absolute_Imprv}(312)$

AFFX: $\text{Attract_of_PDT}(299)$

UNITS: dimensionless

312: $\text{Sensitivity_to_Absolute_Imprv} = 15$

DEFN: Sensitivity of Attractiveness to the Improvement Rate

AFFX: $\text{Eff_of_Imprv_Ratio_on_Manuf_Attract}(300)$ $\text{Eff_of_Impv_on_PDT_Attract}(301)$

UNITS: dimensionless

314: $\text{Total_Attract_of_TQ_Support} = \text{Attract_of_PDT} + \text{Attract_of_Manufacturing}$

DEFN: Total Attractiveness of Allocating TQM Support

USES: $\text{Attract_of_Manufacturing}(298)$ $\text{Attract_of_PDT}(299)$

AFFX: $\text{Frac_TQ_Support_to_Manufacturing}(302)$ $\text{Frac_TQ_Support_to_PDT}(303)$

UNITS: dimensionless

302: $\text{Frac_TQ_Support_to_Manufacturing} = \frac{\text{Attract_of_Manufacturing}}{\text{Total_Attract_of_TQ_Support} + 1e-9}$

DEFN: Fraction of TQM Support Resources Allocated to the Manufacturing Area

USES: $\text{Attract_of_Manufacturing}(298)$ $\text{Total_Attract_of_TQ_Support}(314)$

AFFX: $\text{Ratio_TQ_Resource_To_Req_for_Manuf}(309)$

UNITS: dimensionless

303: $\text{Frac_TQ_Support_to_PDT} = \frac{\text{Attract_of_PDT}}{\text{Total_Attract_of_TQ_Support} + 1e-9}$

DEFN: Fraction of TQM Support Resources Allocated to Support Effort in Reducing Product Development Time

USES: $\text{Attract_of_PDT}(299)$ $\text{Total_Attract_of_TQ_Support}(314)$

AFFX: $\text{Ratio_TQ_Resources_to_Req_for_PDT}(308)$

UNITS: dimensionless

6. Management Accounting

6.0 Overview

This section describes the management accounting system. Managerial accounting plays a critical role in the firm. It generates information that allows the manager to evaluate the performance of the firm. To our knowledge, no systematic exposition of the management accounting function exists in the system dynamics literature. As a result, much of what is presented in this section was developed by the authors. This section draws heavily on standard managerial accounting practices which are described in, among other places, Cost Accounting: A Managerial Approach by Hongren and Foster [1991].

6.1 Cost of Material

6.1.1 Valuing Materials Inventory

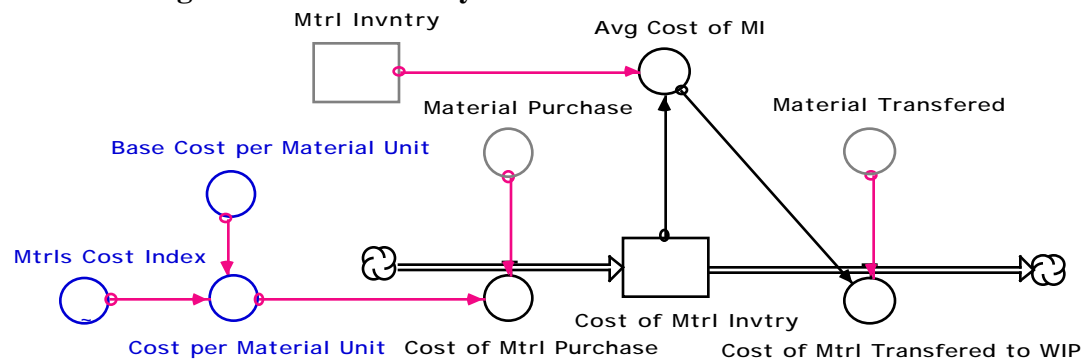

The current value of materials inventory is increased by purchases and decreased as materials are transferred from inventory to work in process. Material purchases are determined in the production sector. As those purchases are made the value of inventory is increased by the number of units purchased multiplied by the current cost per material unit. The current cost per material unit is equal to the base cost per material unit multiplied by the material cost index. The base cost per material unit is assumed to be 40 cents based upon the authors' estimate made during the calibration process. The Producer Price Index is used to index the costs of material and is normalized to one for the eighty-fourth month of the simulation which corresponds to the year 1992.

$$322: \text{Cost_of_Mtrl_Invntry} = \text{Cost_of_Mtrl_Invntry} * (t-dt) + (\text{Cost_of_Mtrl_Purchase} - \text{Cost_of_Mtrl_Transferred_to_WIP}) * dt$$

INIT: Actual_Value_of_Mtrl_Inventory

DEFN: Cost of Material Inventory

USES: Actual_Value_of_Mtrl_Inventory(685) Cost_of_Mtrl_Purchase(323)
Cost_of_Mtrl_Transfered_to_WIP(324)

AFFX: Annualized_Value_of_Mtrl_Inventory(331) Avg_Cost_of_MI(332) Value_of_Inventory(495)
UNITS: dollars

323: $\text{Cost_of_Mtrl_Purchase} = \text{Material_Purchase} * \text{Cost_per_Material_Unit}$

DEFN: Cost of Materials Purchases

USES: Cost_per_Material_Unit(336) Material_Purchase(139)

AFFX: Cost_of_Mtrl_Invtry(322) Net_Change_in_Cost_of_Materials_Inventory(337)

Accts_Payable_Increases(442)

UNITS: dollars/month

336: $\text{Cost_per_Material_Unit} = \text{Base_Cost_per_Material_Unit} * \text{Mtrls_Cost_Index}$

DEFN: Cost of Material Units

USES: Base_Cost_per_Material_Unit(335) Mtrls_Cost_Index(338)

AFFX: Mtrl_Invtry(138) Cost_of_Mtrl_Purchase(323)

UNITS: dollars/unit

335: $\text{Base_Cost_per_Material_Unit} = .4$

DEFN: Base Per Unit Material Cost

AFFX: Cost_per_Material_Unit(336)

UNITS: dollars/unit

338: $\text{Mtrls_Cost_Index} = \text{GRAPH}(\text{TIME})$

DATA: (0.00, 0.78), (3.00, 0.79), (6.00, 0.8), (9.00, 0.81), (12.0, 0.81), (15.0, 0.82), (18.0, 0.83), (21.0, 0.83), (24.0, 0.83), (27.0, 0.84), (30.0, 0.85), (33.0, 0.85), (36.0, 0.86), (39.0, 0.87), (42.0, 0.88), (45.0, 0.88), (48.0, 0.89), (51.0, 0.9), (54.0, 0.91), (57.0, 0.91), (60.0, 0.92), (63.0, 0.94), (66.0, 0.95), (69.0, 0.96), (72.0, 0.96), (75.0, 0.97), (78.0, 0.98), (81.0, 0.99), (84.0, 1.00), (87.0, 1.01), (90.0, 1.02), (93.0, 1.02), (96.0, 1.03)

DEFN: Materials Cost Index (Producer Price Index)

AFFX: Cost_per_Material_Unit(336) Combined_Price_Index(579)

UNITS: dimensionless

The value of inventory is decreased each time materials are transferred to work in process. Rather than use normal inventory valuation methods such as LIFO or FIFO, the inventory is decreased by the average unit cost of materials in the inventory each time a unit is transferred. This average is calculated by dividing the current cost of inventory by the number of physical units in the inventory.

324: $\text{Cost_of_Mtrl_Transfered_to_WIP} = \text{Avg_Cost_of_MI} * \text{Material_Transfered}$

DEFN: Cost of Materials Transferred from Inventory to Work in Process

USES: Avg_Cost_of_MI(332) Material_Transfered(140)

AFFX: Cost_of_Mtrl_Invtry(322)

UNITS: dollars/month

332: $\text{Avg_Cost_of_MI} = \text{Cost_of_Mtrl_Invtry} / \text{Mtrl_Invtry}$

DEFN: Average Cost of Units in the Materials Inventory

USES: Cost_of_Mtrl_Invtry(322) Mtrl_Invntry(138)

AFFX: Cost_of_Mtrl_Transfered_to_WIP(324) M_Cost_of_WIP(328) M_Cost_of_Wafer_Starts(329)

UNITS: dollars/month

6.1.2 Material Cost of Work in Process and Finished Goods Inventory

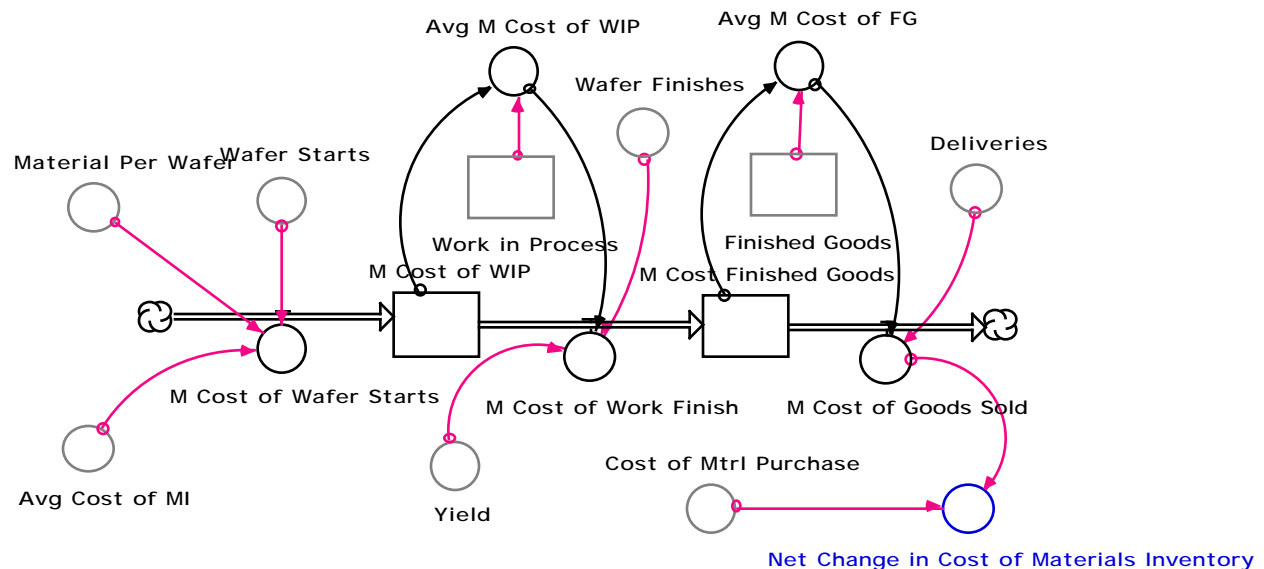

The materials cost of work in process is increased by wafer starts and decreased as wafers are finished. Each time a wafer is started the cost of WIP is increased by an amount equal to the current average cost of materials inventory multiplied by the required number of material units per wafer. This quantity is exactly equal to the amount deducted from the cost of materials inventory since wafer starts and material transfers are equal. When a wafer is completed the cost of WIP is decreased by the current average cost of per unit of WIP divided by the current manufacturing yield. The quantity is divided by the wafer yield to account for the cost of materials that were previously allocated to wafers that were scrapped in the production process. The formulation assumes that the cost of scrap is allocated equally to the remaining units. The average material cost of WIP is calculated by dividing the total cost of WIP by the number of units currently in the WIP .

$$328: M_Cost_of_WIP = M_Cost_of_WIP *(t-dt) + (M_Cost_of_Wafer_Starts - M_Cost_of_Work_Finish) * dt$$

INIT: Work_in_Process*Avg_Cost_of_MI

DEFN: Materials Cost of Work in Process

USES: Avg_Cost_of_MI(332) M_Cost_of_Wafer_Starts(329) M_Cost_of_Work_Finish(330) Work_in_Process(151)

AFFX: Avg_M_Cost_of_WIP(334) Value_of_WIP(407)

UNITS: dollars

$$329: M_Cost_of_Wafer_Starts = Wafer_Starts * Avg_Cost_of_MI * Material_per_Wafer$$

DEFN: Materials Cost of Wafers Started

USES: Avg_Cost_of_MI(332) Wafer_Starts(152) Material_Per_Wafer(143)

AFFX: M_Cost_of_WIP(328)

UNITS: dollars/month

$$330: M_Cost_of_Work_Finish = Avg_M_Cost_of_WIP * Wafer_Finishes / Yield$$

DEFN: Materials Cost of Work Finished
 USES: Avg_M_Cost_of_WIP(334) Wafer_Finishes(154) Yield(265)
 AFFX: M_Cost_Finished_Goods(325) M_Cost_of_WIP(328)
 UNITS: dollars/month

$$334: Avg_M_Cost_of_WIP = M_Cost_of_WIP / Work_in_Process$$

DEFN: Average Materials Cost of Work in Process
 USES: M_Cost_of_WIP(328) Work_in_Process(151)
 AFFX: M_Cost_Finished_Goods(325) M_Cost_of_Work_Finish(326) M_Cost_of_Work_Finish(330)
 UNITS: dollars/unit

The materials cost of finished goods inventory is increased by the completion of wafers and decreased by shipments. When a wafer is shipped as a finished product, the materials cost of finished goods inventory is decreased by an amount equal to the current average materials cost of a unit in the finished goods inventory. The average cost is calculated in the standard manner; the total materials cost divided by the number of units in the inventory.

$$325: M_Cost_Finished_Goods = M_Cost_Finished_Goods * (t-dt) + (M_Cost_of_Work_Finish - M_Cost_of_Goods_Sold) * dt$$

INIT: Finished_Goods * Avg_M_Cost_of_WIP / Actual_Yield

DEFN: Materials Cost of Finished Goods Inventory
 USES: Actual_Yield(687) Avg_M_Cost_of_WIP(334) Finished_Goods(148)
 M_Cost_of_Goods_Sold(327) M_Cost_of_Work_Finish(330)
 AFFX: Avg_M_Cost_of_FG(333) Value_of_Finished_Goods_Inventory(406)
 UNITS: dollars

$$326: M_Cost_of_Work_Finish = Avg_M_Cost_of_WIP * Wafer_Finishes / Yield$$

DEFN: Materials Cost of Wafers Completed
 USES: Avg_M_Cost_of_WIP(334) Wafer_Finishes(154) Yield(265)
 UNITS: dollars/month

$$327: M_Cost_of_Goods_Sold = Avg_M_Cost_of_FG * Deliveries$$

DEFN: Materials Cost of Goods Sold
 USES: Avg_M_Cost_of_FG(333) Deliveries(150)
 AFFX: M_Cost_Finished_Goods(325) Net_Change_in_Cost_of_Materials_Inventory(337)
 Cost_of_Goods_Sold(401) Prct_Materials_COGS(405)
 UNITS: dollars/month

$$333: Avg_M_Cost_of_FG = M_Cost_Finished_Goods / Finished_Goods$$

DEFN: Average Materials Cost of Units in the Finished Goods Inventory
 USES: Finished_Goods(148) M_Cost_Finished_Goods(325)
 AFFX: M_Cost_of_Goods_Sold(327)
 UNITS: dollars/unit

Finally, for the purpose of reconciling the statement of cash flow, the net change in the cost of inventory is calculated as the cost of materials purchased minus the materials cost of units sold.

337: Net_Change_in_Cost_of_Materials_Inventory = Cost_of_Mtrl_Purchase-M_Cost_of_Goods_Sold

DEFN: Net Change in the Total Cost of Material Holdings

USES: Cost_of_Mtrl_Purchase(323) M_Cost_of_Goods_Sold(327)

AFFX: Net_Change_in_Cost_of_Inventory(503)

UNITS: dollars/month

6.2 Production Expenses

6.2.1 Product Attributable Overhead

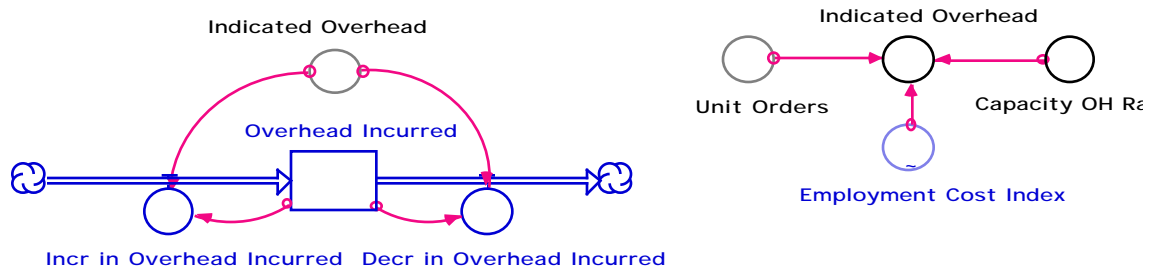

The formulations presented in this sub-section determine the amount of spending on product attributable overhead. Product attributable overhead expenses are those that, although they may not be directly attributable to a specific unit produced, electrical power for machines for example, they can nonetheless be included in the cost of goods sold. The indicated overhead spending, that amount that would be spent assuming complete factor flexibility, is assumed to be a direct function of the number of units sold. The overhead rate is assumed to be four dollars per unit sold. This value was chosen on the basis of information taken from interviews and the authors' judgment made during the process of model calibration [Sutter 1993]. The base overhead cost is also discounted by the employment cost index. The employment cost index has been normalized to one for the eighty-fourth month, January 1992.

$$348: \text{Indicated_Overhead} = \text{Unit_Orders} * \text{Capacity_OH_Rate} * \text{Employment_Cost_Index}$$

DEFN: Indicated Overhead Expense

USES: Capacity_OH_Rate(345) Employment_Cost_Index(690) Unit_Orders(113)

AFFX: Overhead_Incurred(339) Incr_in_Overhead_Incurred(340) Decr_in_Overhead_Incurred(341)

Budgeted_OH_Spending(360)

UNITS: dollars/month

$$345: \text{Capacity_OH_Rate} = 4$$

DEFN: Capacity Overhead Cost

AFFX: Indicated_Overhead(348)

UNITS: dollars/unit

Actual overhead spending incurred is an asymmetric exponential smooth of the indicated overhead spending. This formulation assumes actual overhead spending adjusts very quickly to increases in the indicated level spending, but adjusts more slowly to decreases in overhead spending. A one month adjustment time constant is assumed for increases while a twenty-four month time constant is assumed for decreases. The asymmetry in adjustment time is assumed for a number of reasons. First, Analog traditionally pursued a policy of no lay-offs. As a result cutting expenses through staff reductions was difficult. Second, Analog is a large decentralized bureaucratic organization.

In such an environment division or area managers are likely to view cuts in budgets or staffing as a direct reduction in their status in the organization, and as a result, resist reductions in spending.

339: $Overhead_Incurred = Overhead_Incurred * (t-dt) + (Incr_in_Overhead_Incurred - Decr_in_Overhead_Incurred) * dt$
 INIT: Indicated_Overhead

DEFN: Overhead Expense Incurred
 USES: Decr_in_Overhead_Incurred(341) Incr_in_Overhead_Incurred(340) Indicated_Overhead(348)
 AFFX: Incr_in_Overhead_Incurred(340) Decr_in_Overhead_Incurred(341)
 Chng_in_Budg_OH_Spending(361) OH_Absorption_Variance(378) Accts_Payable_Increases(442)
 UNITS: dollars/month

340: $Incr_in_Overhead_Incurred = MAX((Indicated_Overhead-Overhead_Incurred)/1,0)$

DEFN: Increase in Overhead Expense Incurred
 USES: Indicated_Overhead(348) Overhead_Incurred(339)
 AFFX: Overhead_Incurred(339)
 UNITS: dollars/month/month

341: $Decr_in_Overhead_Incurred = MAX(-(Indicated_Overhead-Overhead_Incurred)/24,0)$

DEFN: Decrease in Overhead Expense Incurred
 USES: Indicated_Overhead(348) Overhead_Incurred(339)
 AFFX: Overhead_Incurred(339)
 UNITS: dollars/month/month

6.2.2 Non-Product Attributable Overhead

Non-product attributable overhead expenses are those expense incurred in activities that are not directly related to the manufacture of products. This sub-section uses a formulation similar to that of the previous sub-section to determine actual non-product attributable overhead spending. The expenses in this category are divided into three classes based upon Analog's own reporting convention: marketing expense, selling expense, and general and administrative expenses. The indicated spending in each of these areas, that amount that would be spent assuming completely flexible factor acquisition, is assumed to a constant fraction of sales revenue. Each fraction is chosen based upon Analog historical experience.

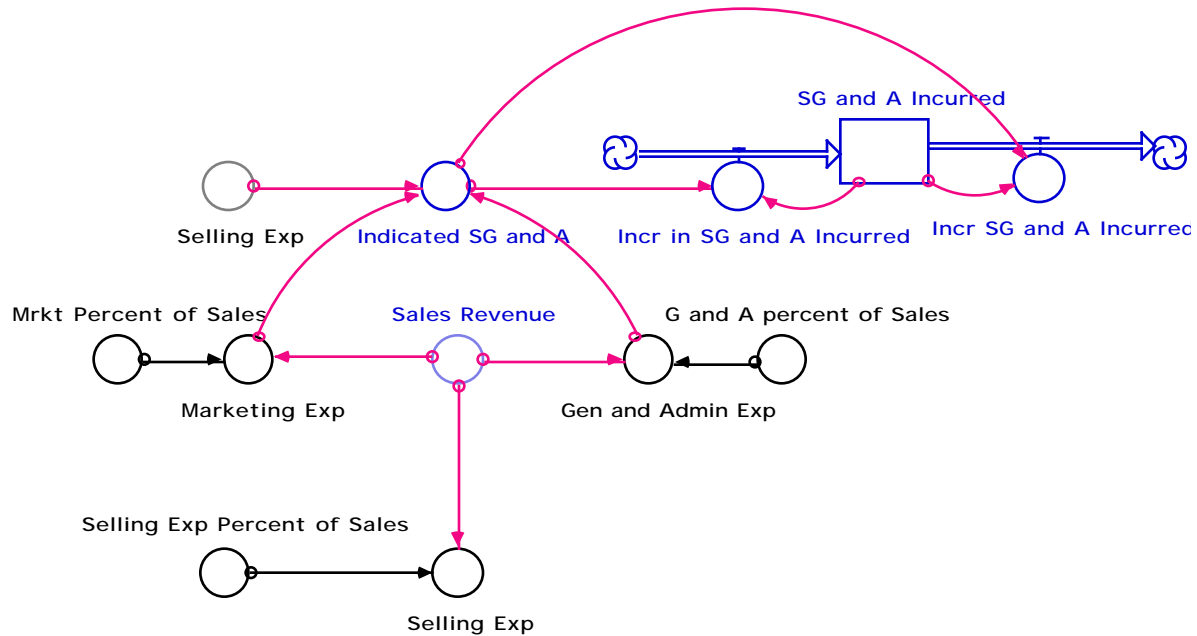

346: $\text{Gen_and_Admin_Exp} = \text{G_and_A_percent_of_Sales} * \text{Sales_Revenue}$

DEFN: General and Administrative Expense
 USES: G_and_A_percent_of_Sales(347) Sales_Revenue(436)
 AFFX: Indicated_SG_and_A(349)
 UNITS: dollars/month

347: $\text{G_and_A_percent_of_Sales} = .10$

DEFN: G and A Expense as a Percent of Sales
 AFFX: Gen_and_Admin_Exp(346)
 UNITS: dimensionless

351: $\text{Marketing_Exp} = \text{Mrkt_Percent_of_Sales} * \text{Sales_Revenue}$

DEFN: Marketing Expense
 USES: Mrkt_Percent_of_Sales(352) Sales_Revenue(436)
 AFFX: Indicated_SG_and_A(349)
 UNITS: dollars/month

352: $\text{Mrkt_Percent_of_Sales} = .06$

DEFN: Marketing Expense as a Percent of Sales Revenue
 AFFX: Marketing_Exp(351)
 UNITS: dimensionless

353: $\text{Selling_Exp} = \text{Selling_Exp_Percent_of_Sales} * \text{Sales_Revenue}$

DEFN: Selling Expense
 USES: Sales_Revenue(436) Selling_Exp_Percent_of_Sales(354)
 AFFX: Indicated_SG_and_A(349)
 UNITS: dollars/month

354: $\text{Selling_Exp_Percent_of_Sales} = .12$

DEFN: Selling Expense as Percent of Sales Revenue

AFFX: $\text{Selling_Exp}(353)$

UNITS: dimensionless

349: $\text{Indicated_SG_and_A} = (\text{Gen_and_Admin_Exp} + \text{Marketing_Exp} + \text{Selling_Exp})$

DEFN: Indicated Sales General and Administrative Expense

USES: $\text{Gen_and_Admin_Exp}(346)$ $\text{Marketing_Exp}(351)$ $\text{Selling_Exp}(353)$

AFFX: $\text{Incr_in_SG_and_A_Incurred}(343)$ $\text{Incr_SG_and_A_Incurred}(344)$

UNITS: dollars/month

The actual overhead expense incurred is an asymmetric exponential smooth of the indicated value. Again, this formulation represents the assumption that actual expenses adjust to increases very quickly but adjust to decreases very slowly. The time constant for adjustments to increase is assumed to be one month, while the time constant for adjustment to decreases is assumed to be forty-eight months. This large differential is justified based upon both Analog's history, the no lay-off policy, and the aforementioned effects of bureaucracy and decentralization.

342: $\text{SG_and_A_Incurred} = \text{SG_and_A_Incurred} * (t-dt) + (\text{Incr_in_SG_and_A_Incurred} - \text{Incr_SG_and_A_Incurred}) * dt$

INIT: $\text{Actual_SG_and_A_by_M}$

DEFN: Sales General and Administrative Expenses Incurred

USES: $\text{Actual_SG_and_A_by_M}(647)$ $\text{Incr_in_SG_and_A_Incurred}(343)$ $\text{Incr_SG_and_A_Incurred}(344)$

AFFX: $\text{Incr_in_SG_and_A_Incurred}(343)$ $\text{Incr_SG_and_A_Incurred}(344)$ $\text{Operating_Exp}(434)$

UNITS: dollars/month

343: $\text{Incr_in_SG_and_A_Incurred} = \text{MAX}((\text{Indicated_SG_and_A} - \text{SG_and_A_Incurred})/1, 0)$

DEFN: Increase in SG and A Expenses Incurred

USES: $\text{Indicated_SG_and_A}(349)$ $\text{SG_and_A_Incurred}(342)$

AFFX: $\text{SG_and_A_Incurred}(342)$

UNITS: dollars/month/month

344: $\text{Decr_SG_and_A_Incurred} = \text{MAX}(-(\text{Indicated_SG_and_A} - \text{SG_and_A_Incurred})/48, 0)$

DEFN: Decrease in SG and A Expenses Incurred

USES: $\text{Indicated_SG_and_A}(349)$ $\text{SG_and_A_Incurred}(342)$

AFFX: $\text{SG_and_A_Incurred}(342)$

UNITS: dollars/month/month

6.2.3 Labor Expense

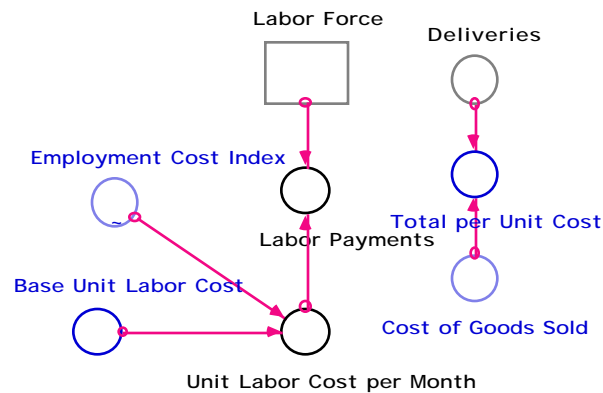

Product attributable labor expense is equal to the current stock of labor multiplied by the current unit labor cost per month. The unit labor cost per month is equal to the assumed base unit cost multiplied by the employment cost index which has been normalized to one for the eighty-fourth month, January 1992. The base unit labor cost is assumed to be \$1500.00 dollars per month. This value was chosen based upon the authors' judgment made during the calibration process. The relatively low value is due to the fact that many workforce activities are not directly attributable to a specific product and thus are accounted for in overhead costs. The unit labor cost represents only the portion of labor costs that can be directly attributed to specific products.

$$350: \text{Labor_Payments} = \text{Unit_Labor_Cost_per_Month} * \text{Labor_Force}$$

DEFN: Labor Payments

USES: Labor_Force(200) Unit_Labor_Cost_per_Month(370)

AFFX: Lbr_Price_Variance(377) Cash_Out(449) Required_Cash_Payments(479)

UNITS: dollars/month

$$370: \text{Unit_Labor_Cost_per_Month} = \text{Base_Unit_Labor_Cost} * \text{Employment_Cost_Index}$$

DEFN: Unit Monthly Labor Cost

USES: Base_Unit_Labor_Cost(368) Employment_Cost_Index(690)

AFFX: Labor_Payments(350) Budgeted_Unit_Lbr_Cost(362) Chng_in_Budgeted_Lbr_Cost(363)

UNITS: dollars/person/month

$$368: \text{Base_Unit_Labor_Cost} = 1500$$

DEFN: Base Monthly Unit Labor Cost

AFFX: Unit_Labor_Cost_per_Month(370)

UNITS: dollars/person/month

$$355: \text{Total_per_Unit_Cost} = \text{Cost_of_Goods_Sold} / \text{Deliveries}$$

DEFN: Total Per Unit Cost

USES: Cost_of_Goods_Sold(401) Deliveries(150)

AFFX: Chng_in_Perceived_Unit_Cost(412)

UNITS: dollars/unit

6.4 Budgeting

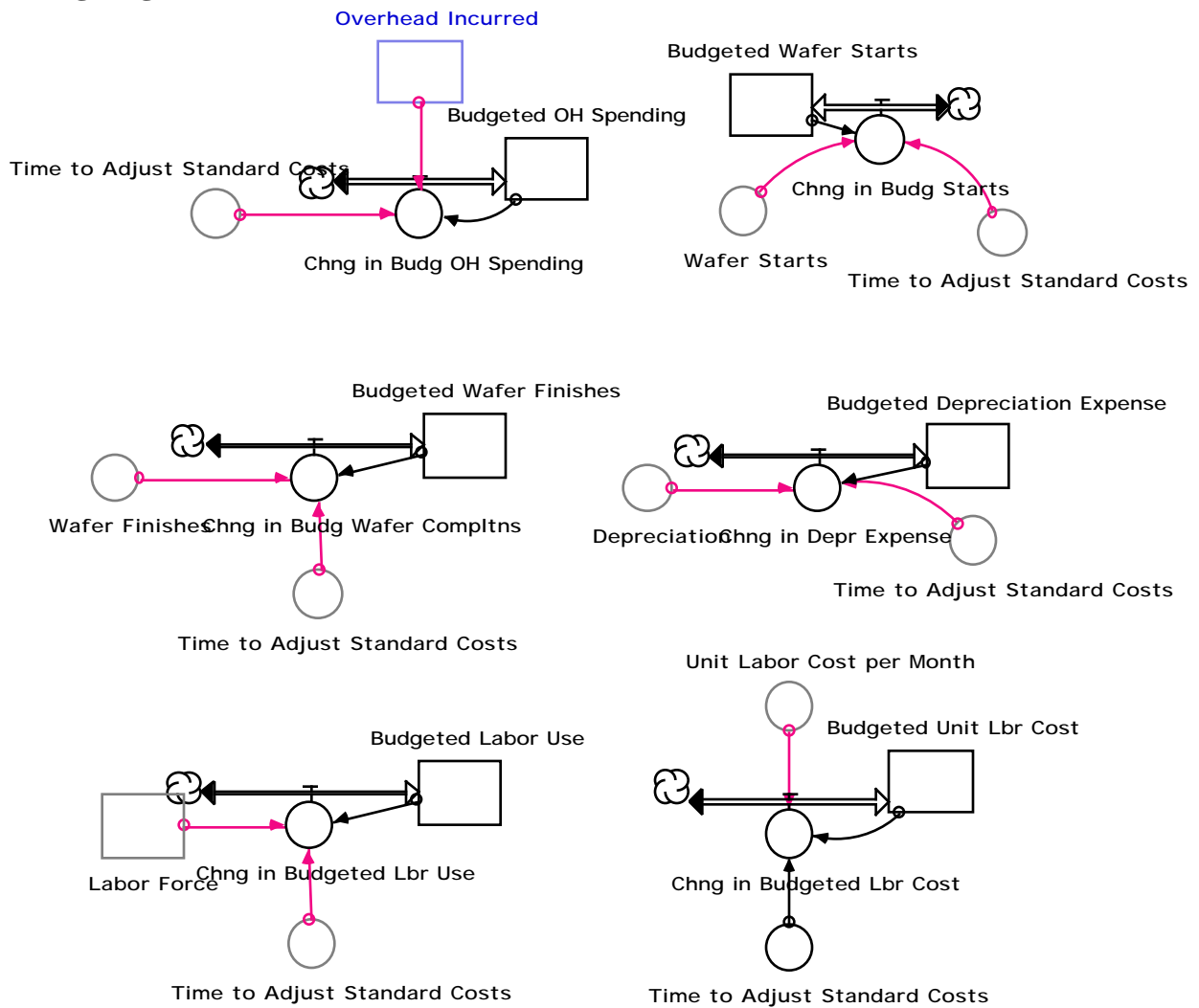

A standard cost accounting system, as described in Hongren and Foster [1992], requires the preparation of periodic budgets which included planned production and expenditures. This process is modeled here as a series of first order, exponentially weighted, moving averages. The process has been widely used to the formation of expectations and forecasts [Sterman 1988 1987, Forrester 1961]. The time constant for each of the budgeting processes is set to be three months based on the assumption of a quarterly budgeting cycle. Depreciation expense is determined in the financial accounting sector and will be discussed later. There are five additional items that are included in the budget: labor use, overhead spending, wafer starts, wafers finishes, and labor costs.

356: $\text{Budgeted_Depreciation_Expense} = \text{Budgeted_Depreciation_Expense} * (t-dt) + (\text{Chng_in_Depr_Expense}) * dt$
 INIT: Depreciation

DEFN: Budgeted Depreciation Expense
 USES: Chng_in_Depr_Expense(357) Depreciation(455)
 AFFX: Chng_in_Depr_Expense(357) Allocated_Cap_Cost_Per_Unit(371)
 Capital_Spending_Variance(374)
 UNITS: dollars/month

357: $\text{Chng_in_Depr_Expense} = (\text{Depreciation} - \text{Budgeted_Depreciation_Expense}) / \text{Time_to_Adjust_Standard_Costs}$

DEFN: Change in the Budgeted Depreciation Expense
 USES: Budgeted_Depreciation_Expense(356) Depreciation(455)
 Time_to_Adjust_Standard_Costs(369)
 AFFX: Budgeted_Depreciation_Expense(356)
 UNITS: dollars/month/month

358: $\text{Budgeted_Labor_Use} = \text{Budgeted_Labor_Use} * (t-dt) + (\text{Chng_in_Budgeted_Lbr_Use}) * dt$
 INIT: Labor_Force

DEFN: Budgeted Labor Use
 USES: Chng_in_Budgeted_Lbr_Use(359) Labor_Force(200)
 AFFX: Chng_in_Budgeted_Lbr_Use(359) Budgeted_Labor_Expenditure(373)
 UNITS: dollars/month

359: $\text{Chng_in_Budgeted_Lbr_Use} = (\text{Labor_Force} - \text{Budgeted_Labor_Use}) / \text{Time_to_Adjust_Standard_Costs}$

DEFN: Change in the Budgeted Labor Use
 USES: Budgeted_Labor_Use(358) Labor_Force(200) Time_to_Adjust_Standard_Costs(369)
 AFFX: Budgeted_Labor_Use(358)
 UNITS: dollars/month/month

360: $\text{Budgeted_OH_Spending} = \text{Budgeted_OH_Spending} * (t-dt) + (\text{Chng_in_Budg_OH_Spending}) * dt$
 INIT: Indicated_Overhead

DEFN: Budgeted Overhead Spending
 USES: Chng_in_Budg_OH_Spending(361) Indicated_Overhead(348)
 AFFX: Chng_in_Budg_OH_Spending(361) OH_Burden_Rate(379)
 UNITS: dollars/month

361: $\text{Chng_in_Budg_OH_Spending} = (\text{Overhead_Incurred} - \text{Budgeted_OH_Spending}) / \text{Time_to_Adjust_Standard_Costs}$

DEFN: Change in the Budgeted Overhead Spending
 USES: Budgeted_OH_Spending(360) Overhead_Incurred(339) Time_to_Adjust_Standard_Costs(369)
 AFFX: Budgeted_OH_Spending(360)
 UNITS: dollars/month/month

362: $\text{Budgeted_Unit_Lbr_Cost} = \text{Budgeted_Unit_Lbr_Cost} * (t-dt) + (\text{Chng_in_Budgeted_Lbr_Cost}) * dt$

INIT: Unit_Labor_Cost_per_Month

DEFN: Budgeted Unit Labor Cost

USES: Chng_in_Budgeted_Lbr_Cost(363) Unit_Labor_Cost_per_Month(370)

AFFX: Chng_in_Budgeted_Lbr_Cost(363) Budgeted_Labor_Expenditure(373)

UNITS: dollars/month

363: $\text{Chng_in_Budgeted_Lbr_Cost} = ((\text{Unit_Labor_Cost_per_Month} - \text{Budgeted_Unit_Lbr_Cost}) / \text{Time_to_Adjust_Standard_Costs})$

DEFN: Change in the Budgeted Unit Labor Cost

USES: Budgeted_Unit_Lbr_Cost(362) Time_to_Adjust_Standard_Costs(369)

Unit_Labor_Cost_per_Month(370)

AFFX: Budgeted_Unit_Lbr_Cost(362)

UNITS: dollars/month/month

364: $\text{Budgeted_Wafer_Finishes} = \text{Budgeted_Wafer_Finishes} * (t - dt) + (\text{Chng_in_Budg_Wafer_Compltns}) * dt$

INIT: Wafer_Finishes

DEFN: Budgeted Wafer Finishes

USES: Chng_in_Budg_Wafer_Compltns(365) Wafer_Finishes(154)

AFFX: Chng_in_Budg_Wafer_Compltns(365) Allocated_Cap_Cost_Per_Unit(371)

Allocated_Lbr_Cost_Per_Unit(372) Capital_Volume_Variance(375) Lbr_Efficiency_Variance(376)

OH_Absorption_Variance(378) OH_Burden_Rate(379) OH_Volume_Variance(380)

UNITS: dollars/month

365: $\text{Chng_in_Budg_Wafer_Compltns} = (\text{Wafer_Finishes} - \text{Budgeted_Wafer_Finishes}) / \text{Time_to_Adjust_Standard_Costs}$

DEFN: Change in the Budgeted Wafer Finishes

USES: Budgeted_Wafer_Finishes(364) Time_to_Adjust_Standard_Costs(369) Wafer_Finishes(154)

AFFX: Budgeted_Wafer_Finishes(364)

UNITS: dollars/month/month

366: $\text{Budgeted_Wafer_Starts} = \text{Budgeted_Wafer_Starts} * (t - dt) + (\text{Chng_in_Budg_Starts}) * dt$

INIT: Wafer_Starts

DEFN: Budgeted Wafer Starts

USES: Chng_in_Budg_Starts(367) Wafer_Starts(152)

AFFX: Chng_in_Budg_Starts(367)

UNITS: dollars/month

367: $\text{Chng_in_Budg_Starts} = (\text{Wafer_Starts} - \text{Budgeted_Wafer_Starts}) / \text{Time_to_Adjust_Standard_Costs}$

DEFN: Change in Budgeted Wafer Starts

USES: Budgeted_Wafer_Starts(366) Time_to_Adjust_Standard_Costs(369) Wafer_Starts(152)

AFFX: Budgeted_Wafer_Starts(366)

UNITS: dollars/month/month

369: $\text{Time_to_Adjust_Standard_Costs} = 3$

DEFN: Average Time Required to Adjust Budgets

AFFX: Chng_in_Depr_Expense(357) Chng_in_Budgeted_Lbr_Use(359)

Chng_in_Budg_OH_Spending(361) Chng_in_Budgeted_Lbr_Cost(363)

Chng_in_Budg_Wafer_Compltns(365) Chng_in_Budg_Starts(367)

UNITS: months

6.5 Variance Calculations

A two variance analysis is used to partition the difference between actual and budgeted spending for the three major expense categories.

6.5.1 Capital Variance

The two variances calculated for depreciation expense are a spending variance and a volume variance.

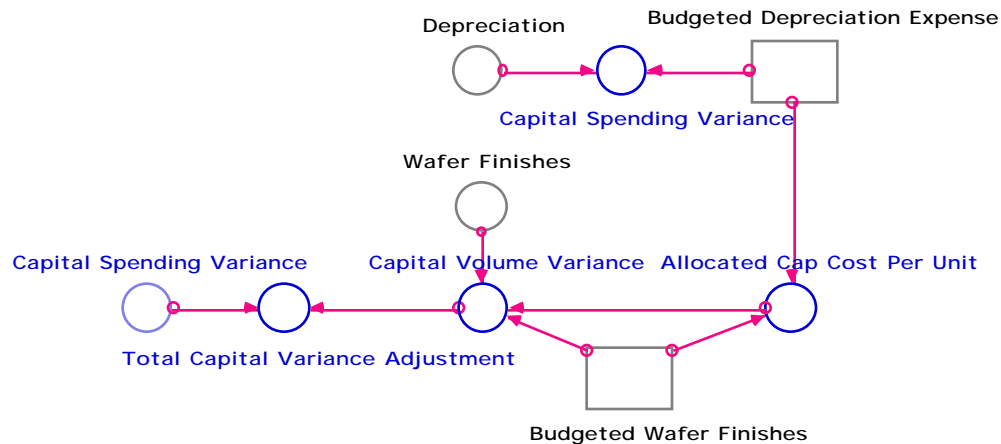

The budgeted capital spending per unit is calculated by dividing the budgeted depreciation expense by the budgeted number of wafer finishes. The capital spending variance is calculated as actual depreciation expense minus the budgeted depreciation expense. The capital volume variance is equal to the difference between actual and budgeted wafer finishes multiplied by the allocated capital cost per unit finished. A total variance adjustment is calculated as the difference between the spending variance and the volume variance.

$$371: \text{Allocated_Cap_Cost_Per_Unit} = \text{Budgeted_Depreciation_Expense} / \text{Budgeted_Wafer_Finishes}$$

DEFN: Allocated Capital Cost Per Unit

USES: Budgeted_Depreciation_Expense(356) Budgeted_Wafer_Finishes(364)

AFFX: Capital_Volume_Variance(375) Capital_Cost_of_FG_Inventory(384)

Incr_in_Cap_Cost_of_FGI(385)

UNITS: dollars/unit

$$374: \text{Capital_Spending_Variance} = \text{Depreciation} - \text{Budgeted_Depreciation_Expense}$$

DEFN: Capital Spending Variance

USES: Budgeted_Depreciation_Expense(356) Depreciation(455)

AFFX: Total_Capital_Variance_Adjustment(381)

UNITS: dollars/month

$$375: \text{Capital_Volume_Variance} = (\text{Wafer_Finishes} - \text{Budgeted_Wafer_Finishes}) * \text{Allocated_Cap_Cost_Per_Unit}$$

DEFN: Capital Volume Variance

USES: Allocated_Cap_Cost_Per_Unit(371) Budgeted_Wafer_Finishes(364) Wafer_Finishes(154)

AFFX: Total_Capital_Variance_Adjustment(381)

UNITS: dollars/month

381: Total_Capital_Variance_Adjustment = Capital_Spending_Variance-Capital_Volume_Variance

DEFN: Total Variance Adjustment for Capital Expense

USES: Capital_Spending_Variance(374) Capital_Volume_Variance(375)

AFFX: Incr_in_Cap_Cost_of_FGI(385)

UNITS: dollars/month

6.5.2 Labor Variances

A similar structure is used for calculating labor related variances.

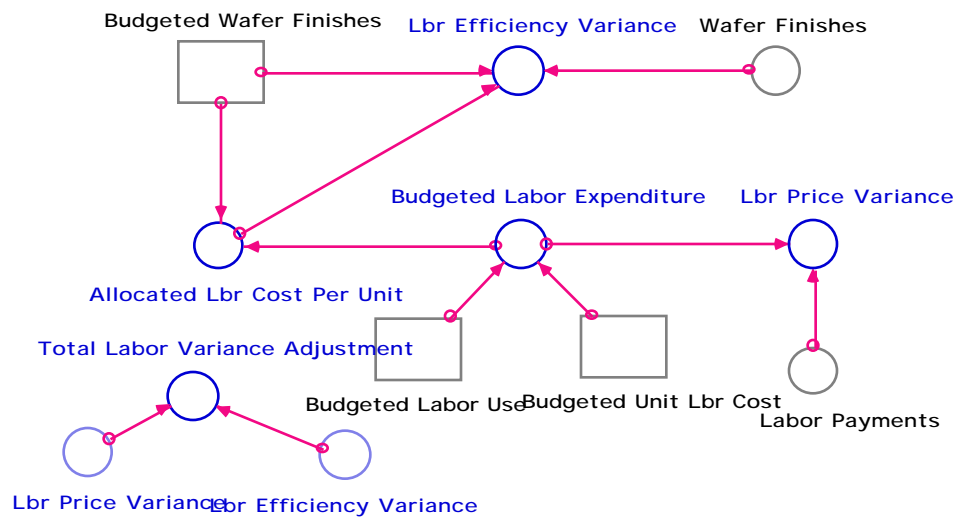

The budgeted labor expenditure is equal to the budgeted labor use multiplied by the budgeted unit labor cost. The allocated labor cost per unit is equal to the budgeted labor expenditure divided by the budgeted number of wafer finishes. The labor price variance is calculated as the actual labor expense minus the budgeted labor expense. The labor efficiency variance is equal to the difference between actual and budgeted wafer finishes multiplied by the allocated cost per labor unit. The total variance adjustment is the labor price variance minus the labor efficiency variance.

373: Budgeted_Labor_Expenditure = Budgeted_Unit_Lbr_Cost*Budgeted_Labor_Use

DEFN: Budgeted Labor Expenditure

USES: Budgeted_Labor_Use(358) Budgeted_Unit_Lbr_Cost(362)

AFFX: Allocated_Lbr_Cost_Per_Unit(372) Lbr_Price_Variance(377) Effect_of_Lbr_Var_on_FS(562)

UNITS: dollars/month

372: Allocated_Lbr_Cost_Per_Unit = Budgeted_Labor_Expenditure/Budgeted_Wafer_Finishes

DEFN: Allocated Labor Cost Per Unit

USES: Budgeted_Labor_Expenditure(373) Budgeted_Wafer_Finishes(364)
 AFFX: Lbr_Efficiency_Variance(376) Labor_Cost_of_Finished_Goods(387)
 Incr_in_Labor_Cost_of_FG(388)
 UNITS: dollars/unit

376: Lbr_Efficiency_Variance = (Wafer_Finishes-
 Budgeted_Wafer_Finishes)*Allocated_Lbr_Cost_Per_Unit

DEFN: Labor Efficiency Variance

USES: Allocated_Lbr_Cost_Per_Unit(372) Budgeted_Wafer_Finishes(364) Wafer_Finishes(154)
 AFFX: Total_Labor_Variance_Adjustment(382) Effect_of_Lbr_Var_on_FS(562)
 UNITS: dollars/month

377: Lbr_Price_Variance = Labor_Payments-Budgeted_Labor_Expenditure

DEFN: Labor Price Variance

USES: Budgeted_Labor_Expenditure(373) Labor_Payments(350)
 AFFX: Total_Labor_Variance_Adjustment(382)
 UNITS: dollars/month

382: Total_Labor_Variance_Adjustment = Lbr_Price_Variance-Lbr_Efficiency_Variance

DEFN: Total Labor Variance Adjustment

USES: Lbr_Efficiency_Variance(376) Lbr_Price_Variance(377)
 AFFX: Incr_in_Labor_Cost_of_FG(388)
 UNITS: dollars/month

6.5.3. Overhead Variances

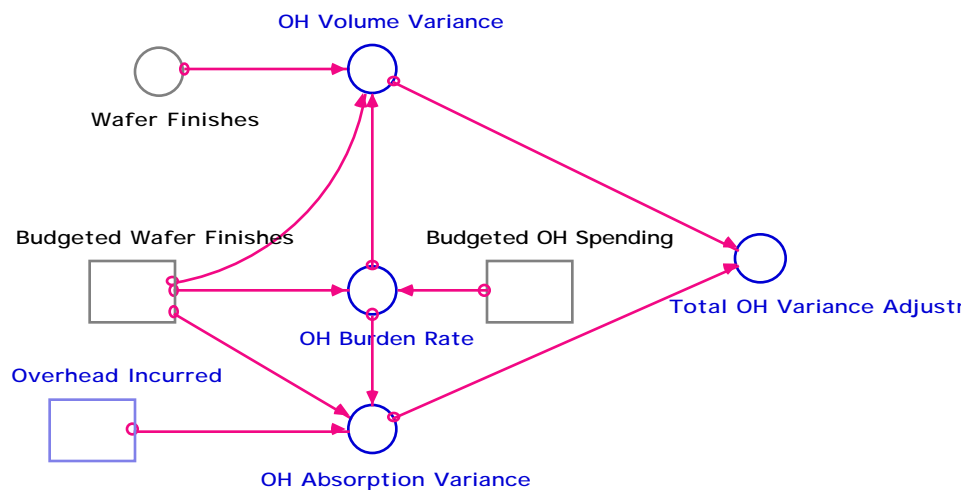

The allocated overhead cost per unit, or the overhead burden rate, is equal to the budgeted level of overhead spending divided by the budgeted number of wafer finishes. The overhead absorption variance is equal to the actual amount of overhead spending minus the budget. The overhead volume variance is equal to the difference between actual and budgeted wafer finishes multiplied by the overhead burden rate. A total variance adjustment is calculated as the overhead absorption variance minus the overhead volume variance.

379: $OH_Burden_Rate = Budgeted_OH_Spending / Budgeted_Wafer_Finishes$

DEFN: Overhead Burden Rate

USES: Budgeted_OH_Spending(360) Budgeted_Wafer_Finishes(364)

AFFX: OH_Absorption_Variance(378) OH_Volume_Variance(380) OH_Cost_of_FGI(390)

OH_Cost_of_Work_Finished(391)

UNITS: dollars/unit

378: $OH_Absorption_Variance = ((Overhead_Incurred / Budgeted_Wafer_Finishes) - OH_Burden_Rate) * Budgeted_Wafer_Finishes$

DEFN: Overhead Absorption Variance

USES: Budgeted_Wafer_Finishes(364) OH_Burden_Rate(379) Overhead_Incurred(339)

AFFX: Total_OH_Variance_Adjustment(383)

UNITS: dollars/month

380: $OH_Volume_Variance = (Wafer_Finishes - Budgeted_Wafer_Finishes) * OH_Burden_Rate$

DEFN: Overhead Volume Variance

USES: Budgeted_Wafer_Finishes(364) OH_Burden_Rate(379) Wafer_Finishes(154)

AFFX: Total_OH_Variance_Adjustment(383)

UNITS: dollars/month

383: $Total_OH_Variance_Adjustment = OH_Absorption_Variance - OH_Volume_Variance$

DEFN: Total Overhead Variance Adjustment Variance

USES: OH_Absorption_Variance(378) OH_Volume_Variance(380)

AFFX: OH_Cost_of_Work_Finished(391)

UNITS: dollars/month

6.6 Cost Tracking Co-Flows

The structures used to determine the capital, labor, and overhead costs to be allocated to the finished goods inventory are very similar to those described in the section on materials expense. In each case a co-flow formulation is used to track expenses as they are allocated to units leaving work in process, enter finished goods inventory, and leave as shipments. In each case rather than using LIFO or FIFO, the average cost of a unit in inventory is deducted from the inventories total cost each time a unit is sold.

6.6.1 Capital Expense

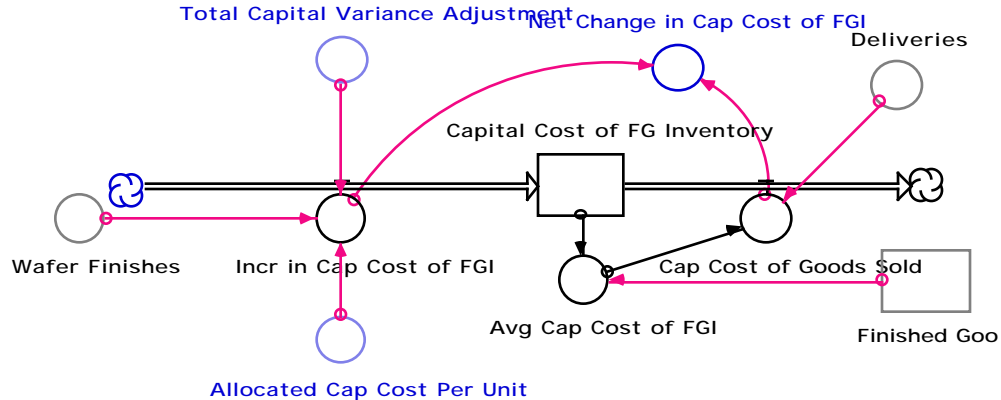

The capital cost of finished goods inventory is increased by wafer finishes and decreased by shipments. The total capital variance adjustment is also added to the inventory cost each period so that all costs are allocated. As each unit is removed from inventory and shipped the cost of inventory is reduced by an amount equal to the current average capital cost of a unit in that inventory. The average cost is calculated by dividing the current inventory cost by the number of units in the finished goods inventory. For the purpose of determining total cash flows the net change in the capital cost of finished goods inventory is calculated as the increase from wafer finishes minus the decrease from shipments.

384: $Capital_Cost_of_FG_Inventory = Capital_Cost_of_FG_Inventory * (t-dt) + (Incr_in_Cap_Cost_of_FGI - Cap_Cost_of_Goods_Sold) * dt$
 INIT: $Finished_Goods * Allocated_Cap_Cost_Per_Unit$

DEFN: Capital Cost of Finished Goods Inventory

USES: $Allocated_Cap_Cost_Per_Unit(371)$ $Cap_Cost_of_Goods_Sold(386)$ $Finished_Goods(148)$
 $Incr_in_Cap_Cost_of_FGI(385)$

AFFX: $Avg_Cap_Cost_of_FGI(393)$ $Value_of_Finished_Goods_Inventory(406)$

UNITS: dollars

385: $Incr_in_Cap_Cost_of_FGI = (Wafer_Finishes * Allocated_Cap_Cost_Per_Unit) + (Total_Capital_Variance_Adjustment)$

DEFN: Increase in the Capital Cost of Finished Goods Inventory

USES: $Allocated_Cap_Cost_Per_Unit(371)$ $Total_Capital_Variance_Adjustment(381)$
 $Wafer_Finishes(154)$

AFFX: $Capital_Cost_of_FG_Inventory(384)$ $Net_Change_in_Cap_Cost_of_FGI(396)$

UNITS: dollars/month

386: $Cap_Cost_of_Goods_Sold = Avg_Cap_Cost_of_FGI * Deliveries$

DEFN: Capital Cost of Goods Sold

USES: $Avg_Cap_Cost_of_FGI(393)$ $Deliveries(150)$

AFFX: $Capital_Cost_of_FG_Inventory(384)$ $Net_Change_in_Cap_Cost_of_FGI(396)$

$Cost_of_Goods_Sold(401)$ $Prct_Capital_in_COGS(403)$

UNITS: dollars/month

393: $\text{Avg_Cap_Cost_of_FGI} = \text{Capital_Cost_of_FG_Inventory} / \text{Finished_Goods}$

DEFN: Average Capital Cost of Finished Goods Inventory

USES: $\text{Capital_Cost_of_FG_Inventory}(384)$ $\text{Finished_Goods}(148)$

AFFX: $\text{Cap_Cost_of_Goods_Sold}(386)$

UNITS: dollars/unit

396: $\text{Net_Change_in_Cap_Cost_of_FGI} = \text{Incr_in_Cap_Cost_of_FGI} - \text{Cap_Cost_of_Goods_Sold}$

DEFN: Net Change in the Total Capital Cost of Inventory

USES: $\text{Cap_Cost_of_Goods_Sold}(386)$ $\text{Incr_in_Cap_Cost_of_FGI}(385)$

AFFX: $\text{Net_Change_in_Cost_of_Inventory}(503)$

UNITS: dollars/month

6.6.2 Labor Expenses

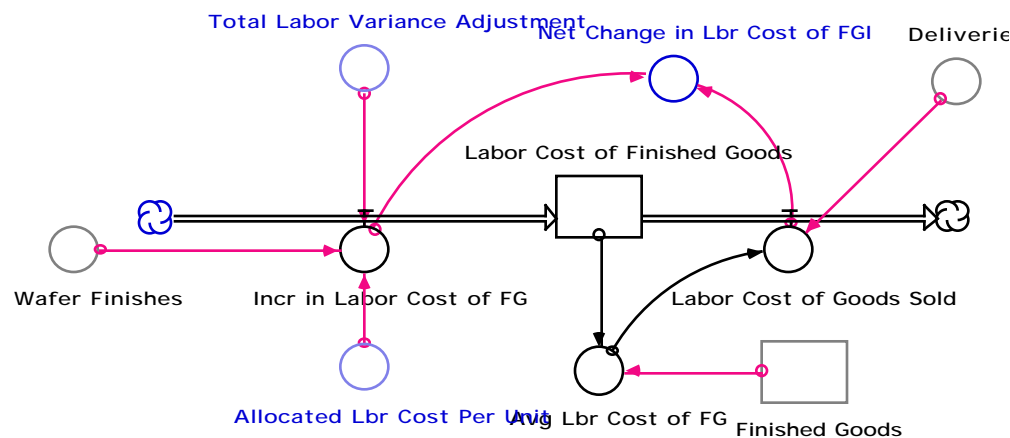

The labor cost of finished goods inventory is increased by wafer finishes and decreased by shipments. The total labor variance adjustment is also added to the inventory cost each period so that all costs are allocated. As each unit is removed from inventory and shipped the cost of inventory is reduced by an amount equal to the current average labor cost of a unit in that inventory. The average cost is calculated by dividing the current inventory cost by the number of units in the finished goods inventory. For the purpose of determining total cash flows the net change in the labor cost of finished goods inventory is calculated as the increase from wafer finishes minus the decrease from shipments.

387: $\text{Labor_Cost_of_Finished_Goods} = \text{Labor_Cost_of_Finished_Goods} * (t-dt) +$

$(\text{Incr_in_Labor_Cost_of_FG} - \text{Labor_Cost_of_Goods_Sold}) * dt$

INIT: $\text{Finished_Goods} * \text{Allocated_Lbr_Cost_Per_Unit}$

DEFN: Labor Cost of Finished Goods Inventory

USES: $\text{Allocated_Lbr_Cost_Per_Unit}(372)$ $\text{Finished_Goods}(148)$ $\text{Incr_in_Labor_Cost_of_FG}(388)$

$\text{Labor_Cost_of_Goods_Sold}(389)$

AFFX: $\text{Avg_Lbr_Cost_of_FG}(394)$ $\text{Value_of_Finished_Goods_Inventory}(406)$

UNITS: dollars

388: $\text{Incr_in_Labor_Cost_of_FG} = (\text{Wafer_Finishes} * \text{Allocated_Lbr_Cost_Per_Unit}) + \text{Total_Labor_Variance_Adjustment}$

DEFN: Increase in the Labor Cost of Finished Goods Inventory
 USES: Allocated_Lbr_Cost_Per_Unit(372) Total_Labor_Variance_Adjustment(382)
 Wafer_Finishes(154)
 AFFX: Labor_Cost_of_Finished_Goods(387) Net_Change_in_Lbr_Cost_of_FGI(397)
 UNITS: dollars/month

389: $\text{Labor_Cost_of_Goods_Sold} = \text{Deliveries} * \text{Avg_Lbr_Cost_of_FG}$

DEFN: Labor Cost of Goods Sold
 USES: Avg_Lbr_Cost_of_FG(394) Deliveries(150)
 AFFX: Labor_Cost_of_Finished_Goods(387) Net_Change_in_Lbr_Cost_of_FGI(397)
 Cost_of_Goods_Sold(401) Prct_Labor_COGS(404)
 UNITS: dollars/month

394: $\text{Avg_Lbr_Cost_of_FG} = \text{Labor_Cost_of_Finished_Goods} / \text{Finished_Goods}$

DEFN: Average Labor Cost of Finished Goods
 USES: Finished_Goods(148) Labor_Cost_of_Finished_Goods(387)
 AFFX: Labor_Cost_of_Goods_Sold(389)
 UNITS: dollars/unit

397: $\text{Net_Change_in_Lbr_Cost_of_FGI} = \text{Incr_in_Labor_Cost_of_FG} - \text{Labor_Cost_of_Goods_Sold}$

DEFN: Net Change in the Labor Cost of Inventory
 USES: Incr_in_Labor_Cost_of_FG(388) Labor_Cost_of_Goods_Sold(389)
 AFFX: Net_Change_in_Cost_of_Inventory(503)
 UNITS: dollars/month

6.6.3 Overhead Expenses

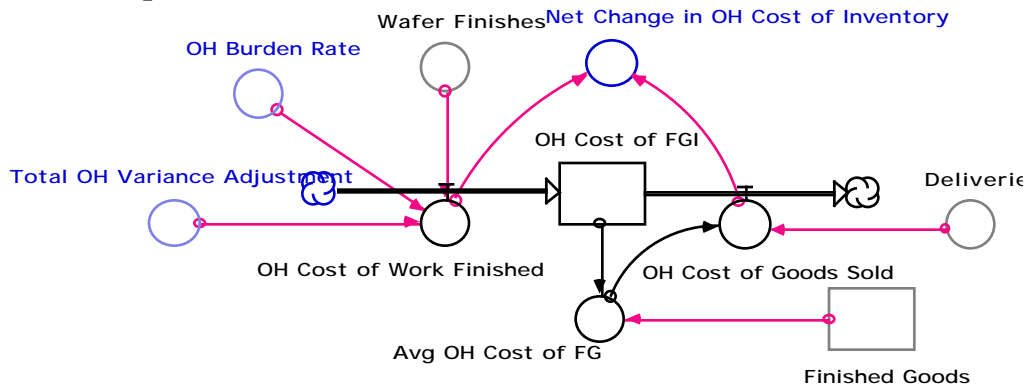

The overhead cost of finished goods inventory is increased by wafer finishes and decreased by shipments. The total overhead variance adjustment is also added to the inventory cost each period so that all costs are allocated. As each unit is removed from inventory and shipped the cost of inventory is reduced by an amount equal to the current average labor cost of a unit in that inventory. The average cost is calculated by dividing the current inventory cost by the number of units in the finished goods inventory. For the purpose of determining total cash flows the net

change in the overhead cost of finished goods inventory is calculated as the increase from wafer finishes minus the decrease from shipments.

390: $OH_Cost_of_FGI = OH_Cost_of_FGI \cdot (t-dt) + (OH_Cost_of_Work_Finished - OH_Cost_of_Goods_Sold) \cdot dt$
 INIT: Finished_Goods*OH_Burden_Rate

DEFN: Overhead Cost of Finished Goods Inventory
 USES: Finished_Goods(148) OH_Burden_Rate(379) OH_Cost_of_Goods_Sold(392)
 OH_Cost_of_Work_Finished(391)
 AFFX: Avg_OH_Cost_of_FG(395) Value_of_Finished_Goods_Inventory(406)
 UNITS: dollars

391: $OH_Cost_of_Work_Finished = Wafer_Finishes \cdot OH_Burden_Rate + Total_OH_Variance_Adjustment$

DEFN: Overhead Cost of Work Finished
 USES: OH_Burden_Rate(379) Total_OH_Variance_Adjustment(383) Wafer_Finishes(154)
 AFFX: OH_Cost_of_FGI(390) Net_Change_in_OH_Cost_of_Inventory(398)
 UNITS: dollars/month

392: $OH_Cost_of_Goods_Sold = Avg_OH_Cost_of_FG \cdot Deliveries$

DEFN: Overhead Cost of Goods Sold
 USES: Avg_OH_Cost_of_FG(395) Deliveries(150)
 AFFX: OH_Cost_of_FGI(390) Net_Change_in_OH_Cost_of_Inventory(398) Cost_of_Goods_Sold(401)
 Percent_OH_COGS(402)
 UNITS: dollars/month

395: $Avg_OH_Cost_of_FG = OH_Cost_of_FGI / Finished_Goods$

DEFN: Average Overhead Cost of Finished Goods Inventory
 USES: Finished_Goods(148) OH_Cost_of_FGI(390)
 AFFX: OH_Cost_of_Goods_Sold(392) Value_of_WIP(407)
 UNITS: dollars/unit

398: $Net_Change_in_OH_Cost_of_Inventory = OH_Cost_of_Work_Finished - OH_Cost_of_Goods_Sold$

DEFN: Net Change in the Overhead Cost of Inventory
 USES: OH_Cost_of_Goods_Sold(392) OH_Cost_of_Work_Finished(391)
 AFFX: Net_Change_in_Cost_of_Inventory(503)
 UNITS: dollars/month

6.7 Cost of Goods Sold

The total cost of goods sold is equal to the sum of the four outflows from the inventory cost flows. Each type of cost is also calculated as a percentage of the total cost of goods sold.

401: Cost_of_Goods_Sold =
 M_Cost_of_Goods_Sold+Labor_Cost_of_Goods_Sold+Cap_Cost_of_Goods_Sold+OH_Cost_of_Goods_Sold

DEFN: Cost of Goods Sold

USES: Cap_Cost_of_Goods_Sold(386) Labor_Cost_of_Goods_Sold(389)

M_Cost_of_Goods_Sold(327) OH_Cost_of_Goods_Sold(392)

AFFX: Total_per_Unit_Cost(355) Percent_OH_COGS(402) Prct_Capital_in_COGS(403)

Prct_Labor_COGS(404) Prct_Materials_COGS(405) Gross_Margin(431) CoS_In_(615)

Per_Unit_Cogs(660)

UNITS: dollars/month

402: Percent_OH_COGS = OH_Cost_of_Goods_Sold/(Cost_of_Goods_Sold+.001)

DEFN: Percent of Total Cost of Goods Sold from Overhead

USES: Cost_of_Goods_Sold(401) OH_Cost_of_Goods_Sold(392)

UNITS: dimensionless

403: Prct_Capital_in_COGS = Cap_Cost_of_Goods_Sold/(Cost_of_Goods_Sold+.001)

DEFN: Percent of Total Cost of Goods Sold from Capital Expense

USES: Cap_Cost_of_Goods_Sold(386) Cost_of_Goods_Sold(401)

UNITS: dimensionless

404: Prct_Labor_COGS = Labor_Cost_of_Goods_Sold/(Cost_of_Goods_Sold+.001)

DEFN: Percent of Total Cost of Goods Sold from Labor

USES: Cost_of_Goods_Sold(401) Labor_Cost_of_Goods_Sold(389)

UNITS: dimensionless

405: Prct_Materials_COGS = M_Cost_of_Goods_Sold/(Cost_of_Goods_Sold+.001)

DEFN: Percent of Total Cost of Goods Sold from Materials

USES: Cost_of_Goods_Sold(401) M_Cost_of_Goods_Sold(327)

UNITS: dimensionless

6.8 Total Inventory Value

The total value of finished goods inventory is simply the sum of the four types of inventory costs calculated in the structures discussed above. The value of work in process inventory is equal to the material cost of work in process plus average overhead cost of finished goods multiplied by the number of units in WIP, and then multiplied by the wafer yield since scrap is not recognized until after wafers are completed. Labor and capital expense are not allocated to wafers until after they have been completed.

406: Value_of_Finished_Goods_Inventory =
 Capital_Cost_of_FG_Inventory+M_Cost_Finished_Goods+OH_Cost_of_FGI+Labor_Cost_of_Finished_Goods

DEFN: Value of Finished Goods Inventory

USES: Capital_Cost_of_FG_Inventory(384) Labor_Cost_of_Finished_Goods(387)

M_Cost_Finished_Goods(325) OH_Cost_of_FGI(390)

AFFX: Value_of_Inventory(495)

UNITS: dollars

$$407: \text{Value_of_WIP} = \text{M_Cost_of_WIP} + \text{Work_in_Process} * \text{Yield} * \text{Avg_OH_Cost_of_FG}$$

DEFN: Value of Work in Process

USES: Avg_OH_Cost_of_FG(395) M_Cost_of_WIP(328) Work_in_Process(151) Yield(265)

AFFX: Value_of_Inventory(495)

UNITS: dollars

7. Pricing

7.0 Overview

This section discusses the formulation used to determine the average price charged for Analog's products. An indicated price is determined based upon the target profit margin and the perceived unit production cost. The indicated price is then adjusted to reflect changes in the supply demand balance and the competitor's price to determine the actual price. Time delays in the perception and adjustment process are also represented.

7.1 Target Profit Margin

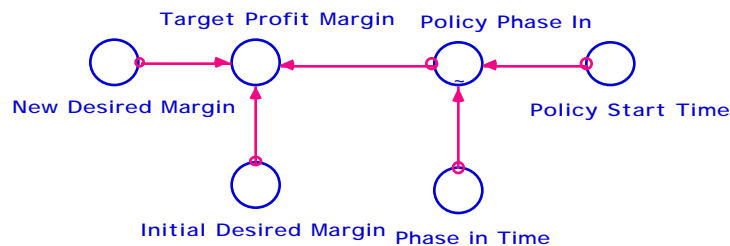

For the base case simulation the target operating margin is assumed to be constant at 52% based on information taken from Analog annual reports [Analog Devices 1985, 1986, 1987, 1988, 1989, 1990]. For the purpose of testing alternative policies this structure allows for exogenous changes in the target profit margin

$$418: \text{Initial_Desired_Margin} = .52$$

DEFN: Initial Target Operating Profit Margin

AFFX: Target_Profit_Margin(426)

UNITS: dimensionless

$$419: \text{New_Desired_Margin} = .55$$

DEFN: New Target Operating Profit Margin (for policy testing only)

AFFX: Target_Profit_Margin(426)

UNITS: dimensionless

$$421: \text{Phase_in_Time} = 12$$

DEFN: Pricing Policy Phase-In Time

AFFX: Policy_Phase_In(430)

UNITS: months

422: Policy_Start_Time = 42E9

DEFN: Pricing Policy Start Time
 AFFX: Policy_Phase_In(430)
 UNITS: months

426: Target_Profit_Margin = (Policy_Phase_In*Initial_Desired_Margin)+(New_Desired_Margin*(1-Policy_Phase_In))

DEFN: Target Operating Profit Margin
 USES: Initial_Desired_Margin(418) New_Desired_Margin(419) Policy_Phase_In(430)
 AFFX: Target_Price(425)
 UNITS: dimensionless

430: Policy_Phase_In = GRAPH((TIME-Policy_Start_Time)/Phase_in_Time)
 DATA: (0.00, 1.00), (1.00, 0.00)

DEFN: Pricing Policy Phase In
 USES: Phase_in_Time(421) Policy_Start_Time(422)
 AFFX: Target_Profit_Margin(426)
 UNITS: dimensionless

7.2 Target Price

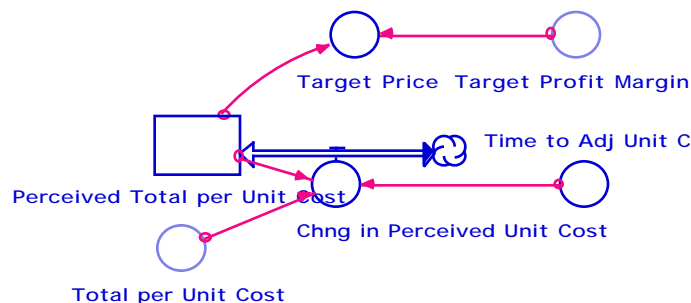

The target price is determined by dividing the current perceived total unit production cost by the quantity one minus the target profit margin. This results in a price which yields the desired operating margin.

425: Target_Price = Perceived_Total_per_Unit_Cost/(1-Target_Profit_Margin)

DEFN: Target Price
 USES: Perceived_Total_per_Unit_Cost(411) Target_Profit_Margin(426)
 AFFX: Price(413) Indicated_Price(417)
 UNITS: dollars/unit

The perceived unit production cost is a first order exponentially weighted average of the actual production cost. The delay represent the time required for unit production costs to be calculated and that information communicated to those making pricing decisions. The time constant for this process is set to three months based upon the assumed quarterly budgeting cycle. The initial value

for perceived unit cost is assumed to 15% above Analog's actual cost for the relevant time period. Unit costs were falling at the time. The assumed smoothing procedure induces an upward bias given a declining input, yielding the appropriate steady state relationship between actual and perceived unit costs.

411: $Perceived_Total_per_Unit_Cost = Perceived_Total_per_Unit_Cost + (Chng_in_Perceived_Unit_Cost) * dt$
 INIT: $Actual_Unit_Cost * 1.15$

DEFN: Perceived Total Unit Cost
 USES: Actual_Unit_Cost(648) Chng_in_Perceived_Unit_Cost(412)
 AFFX: Chng_in_Perceived_Unit_Cost(412) Effective_Margin(416) Indicated_Price(417) Target_Price(425)
 UNITS: dollars/month

412: $Chng_in_Perceived_Unit_Cost = (Total_per_Unit_Cost - Perceived_Total_per_Unit_Cost) / Time_to_Adj_Unit_Cost$

DEFN: Change in the Perceived Total Unit Costs
 USES: Perceived_Total_per_Unit_Cost(411) Time_to_Adj_Unit_Cost(427) Total_per_Unit_Cost(355)
 AFFX: Perceived_Total_per_Unit_Cost(411)
 UNITS: dollars/month/month

427: $Time_to_Adj_Unit_Cost = 3$

DEFN: Average Time Required to Perceived Unit Costs
 AFFX: Chng_in_Perceived_Unit_Cost(412)
 UNITS: months

7.3 Actual Price

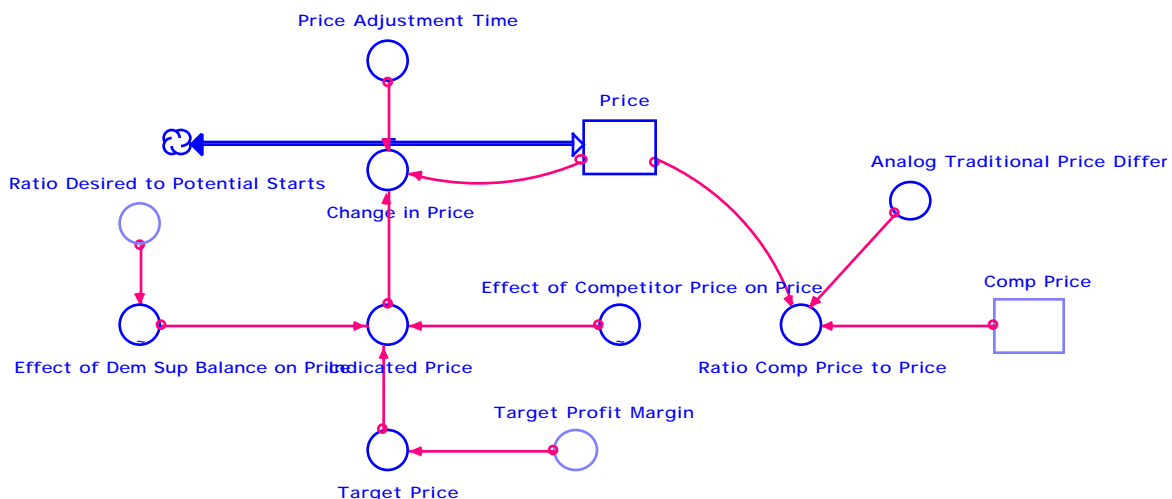

The indicated price is equal to the target price adjusted for the effects of the supply/demand balance and the competitor's price. The adjustments are assumed to affect the indicated price multiplicatively. The effect of competitor price is formulated as a non-linear function of the ratio of

the competitor's price to Analog's price adjusted for the traditional differential in price, assumed always to be ten percent. The 10% differential reflects the premium Analog charged based upon its reputation as a technological leader. The assumed function has a normal point at (1.00,1.00), when the competitor cut its price, the ratio falls below one, the function declines rapidly representing Analog's willingness to follow price cuts by the competitor. Conversely at ratios above one, the function rises slowly, never increasing beyond 1.10, representing an unwillingness, on the part of Analog, to follow the competitor in price increases, preferring instead to increase their share of the market. The effect of the supply demand balance is assumed to be a non-linear function of the ratio of the desired to potential rate of wafer starts. The function is increasing and s-shaped, with a normal point at (1.00,1.00) so that Analog will cut its price to better utilize capacity, but will only raise price slightly if demand exceeds supply.

417: Indicated_Price =
 MAX(Perceived_Total_per_Unit_Cost,Target_Price*Effect_of_Competitor_Price_on_Price*Effect_of_Dem_Sup_Balance_on_Price)

DEFN: Indicated Price
 USES: Effect_of_Competitor_Price_on_Price(428) Effect_of_Dem_Sup_Balance_on_Price(429)
 Perceived_Total_per_Unit_Cost(411) Target_Price(425)
 AFFX: Change_in_Price(414)
 UNITS: dollars/unit

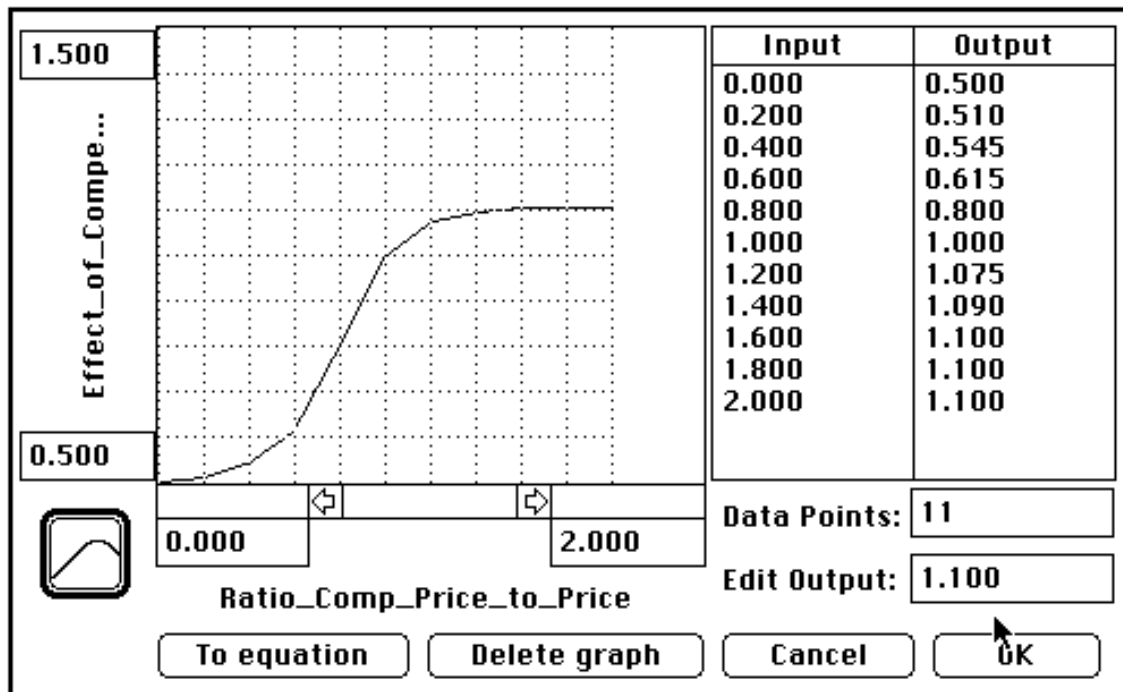

428: $\text{Effect_of_Competitor_Price_on_Price} = \text{GRAPH}(\text{Ratio_Comp_Price_to_Price}) * (1 - \text{Policy_Phase_In}) + \text{Policy_Phase_In}$
 DATA: (0.00, 0.5), (0.2, 0.51), (0.4, 0.545), (0.6, 0.615), (0.8, 0.8), (1, 1.00), (1.20, 1.06), (1.40, 1.09), (1.60, 1.10), (1.80, 1.10), (2.00, 1.10)

DEFN: Effect of Competitor Price on Analog's Price
 USES: Ratio_Comp_Price_to_Price(424) Policy_Phase_In(413)
 AFFX: Indicated_Price(417)
 UNITS: dimensionless

415: Analog_Traditional_Price_Differential = .1

DEFN: Analog's Traditional Price Differential
 AFFX: Ratio_Comp_Price_to_Price(424)
 UNITS: dimensionless

424: $\text{Ratio_Comp_Price_to_Price} = (\text{Comp_Price} / \text{Price}) + \text{Analog_TrAnalogional_Price_Differential}$

DEFN: Ratio of the Competitor's Price to Analog's Price
 USES: Analog_Traditional_Price_Differential(415) Comp_Price(569) Price(413)
 AFFX: Effect_of_Competitor_Price_on_Price(428)
 UNITS: dimensionless

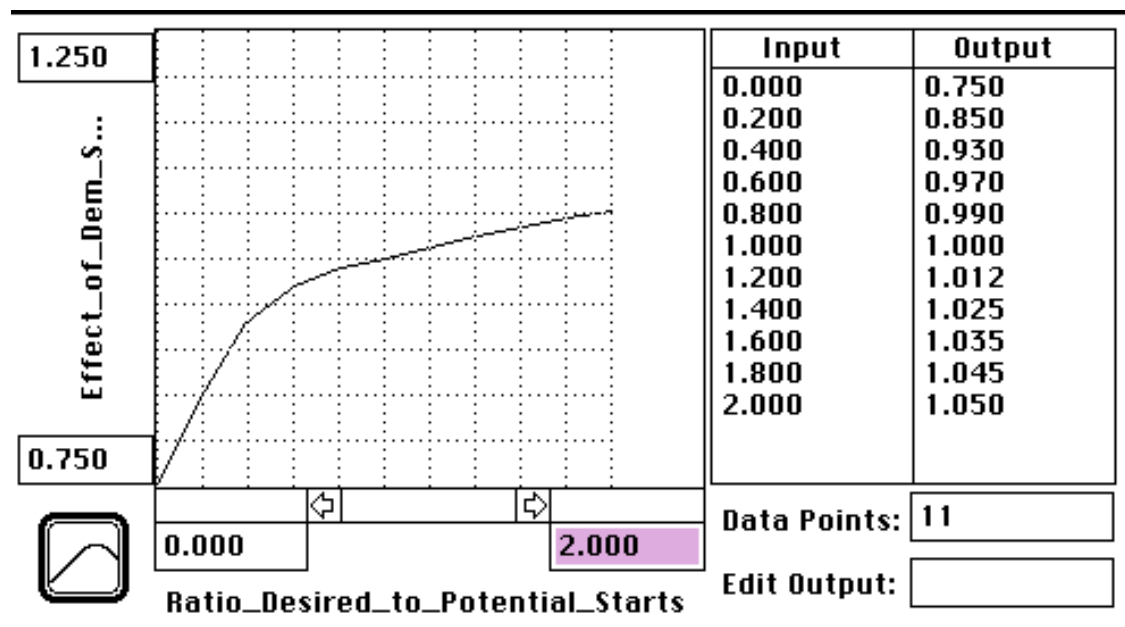

429: $\text{Effect_of_Dem_Sup_Balance_on_Price} = \text{GRAPH}(\text{Ratio_Desired_to_Potential_Starts}) * (1 - \text{Policy_Phase_In}) + \text{Policy_Phase_In}$
 DATA: (0.00, 0.75), (0.2, 0.85), (0.4, 0.93), (0.6, 0.97), (0.8, 0.99), (1, 1.00), (1.20, 1.01), (1.40, 1.02), (1.60, 1.03), (1.80, 1.04), (2.00, 1.05)

DEFN: Effect of the Demand Supply Balance on Analog's Price
 USES: Ratio_Desired_to_Potential_Starts(180) Policy_Phase_In)413

AFFX: Indicated_Price(417)
 UNITS: dimensionless

The actual market price is an exponentially weighted average of the indicated price. This delay represents the time required for price changes to be communicated to the sales force, and for sales materials and price lists to be updated to reflect these changes. The time constant is assumed to be three months.

413: $Price = Price * (t-dt) + (Change_in_Price) * dt$
 INIT: Target_Price

DEFN: Price
 USES: Change_in_Price(414) Target_Price(425)
 AFFX: Eff_of_Price_on_Attract(96) Cum_Price_in_Backlog(408) Incr_in_Cum_Price(409)
 Change_in_Price(414) Effective_Margin(416) Ratio_Comp_Price_to_Price(424) INIT_Price(596)
 Price_Indicated_by_Analog(605)
 UNITS: dollars/unit

414: $Change_in_Price = (Indicated_Price - Price) / Price_Adjustment_Time$

DEFN: Change in Price
 USES: Indicated_Price(417) Price(413) Price_Adjustment_Time(423)
 AFFX: Price(413)
 UNITS: dollars/unit/month

423: Price_Adjustment_Time = 3

DEFN: Average Time Required for Adjustments in Price
 AFFX: Change_in_Price(414)
 UNITS: months

For comparison purpose the effective profit margin is calculated as operating profit per unit divided by the current price.

416: $Effective_Margin = (Price - Perceived_Total_per_Unit_Cost) / Price$

DEFN: Effective Profit Margin
 USES: Perceived_Total_per_Unit_Cost(411) Price(413)
 UNITS: dimensionless

7.4 Tracking Prices in the Backlog

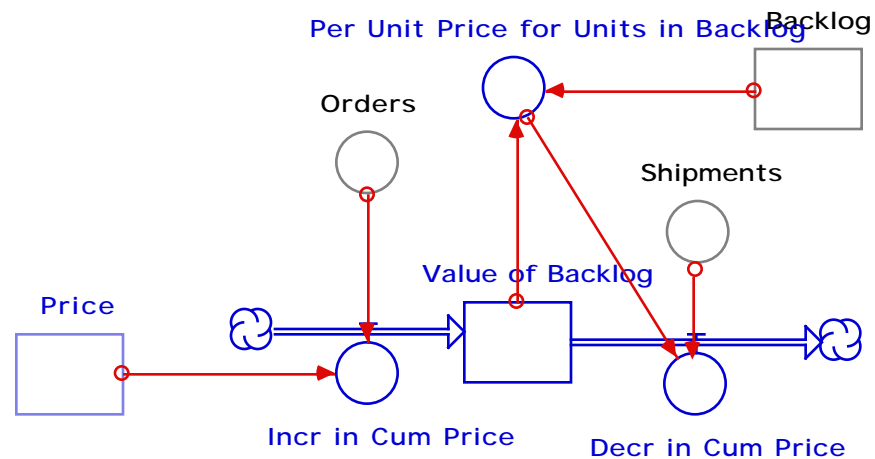

A co-flow structure is used to track the price of units in the backlog. As orders are written the cumulative value of the backlog is increased. The average price of units in the backlog is calculated as the value of the backlog divided by the number of units in the backlog.

408: $\text{Value_of_Backlog} = \text{Value_of_Backlog} * (t - dt) + (\text{Incr_in_Cum_Price} - \text{Decr_in_Cum_Price}) * dt$
 INIT: $\text{Price} * \text{Backlog}$

DEFN: Value of Units in the Backlog
 USES: Backlog(114) Decr_in_Cum_Price(410) Incr_in_Cum_Price(409) Price(413)
 AFFX: Per_Unit_Price_for_Units_in_Backlog(420)
 UNITS: dollars

409: $\text{Incr_in_Cum_Price} = \text{Orders} * \text{Price}$

DEFN: Increase in Value of the Backlog
 USES: Orders(115) Price(413)
 AFFX: Cum_Price_in_Backlog(408)
 UNITS: dollars/month

410: $\text{Decr_in_Cum_Price} = \text{Per_Unit_Price_for_Units_in_Backlog} * \text{Shipments}$

DEFN: Decrease in the Value of the Backlog
 USES: Per_Unit_Price_for_Units_in_Backlog(420) Shipments(116)
 AFFX: Value_of_Backlog(408)
 UNITS: dollars/month

420: $\text{Per_Unit_Price_for_Units_in_Backlog} = \text{Value_of_Backlog} / (\text{Backlog} + 1e-9)$

DEFN: Per Unit Price of Units in the Backlog
 USES: Backlog(114) Cum_Price_in_Backlog(408)
 AFFX: Decr_in_Cum_Price(410) Model_Sales_Revenue(432)
 UNITS: dollars/unit

8 Financial Accounting

8.0 Overview

This section discusses the financial accounting system. The model follows the traditional format for the income statement, the balance sheet, and the statement of cash flows. Many of the equations are direct translations of accounting identities and the sector in general follows Lyneis [1981]. As much as possible the labels and organization of the elements in this sector follows the format used in Analog's annual reports [Analog Devices 1985,1986,1987,1988,1989,1990].

8.1 Income Statement

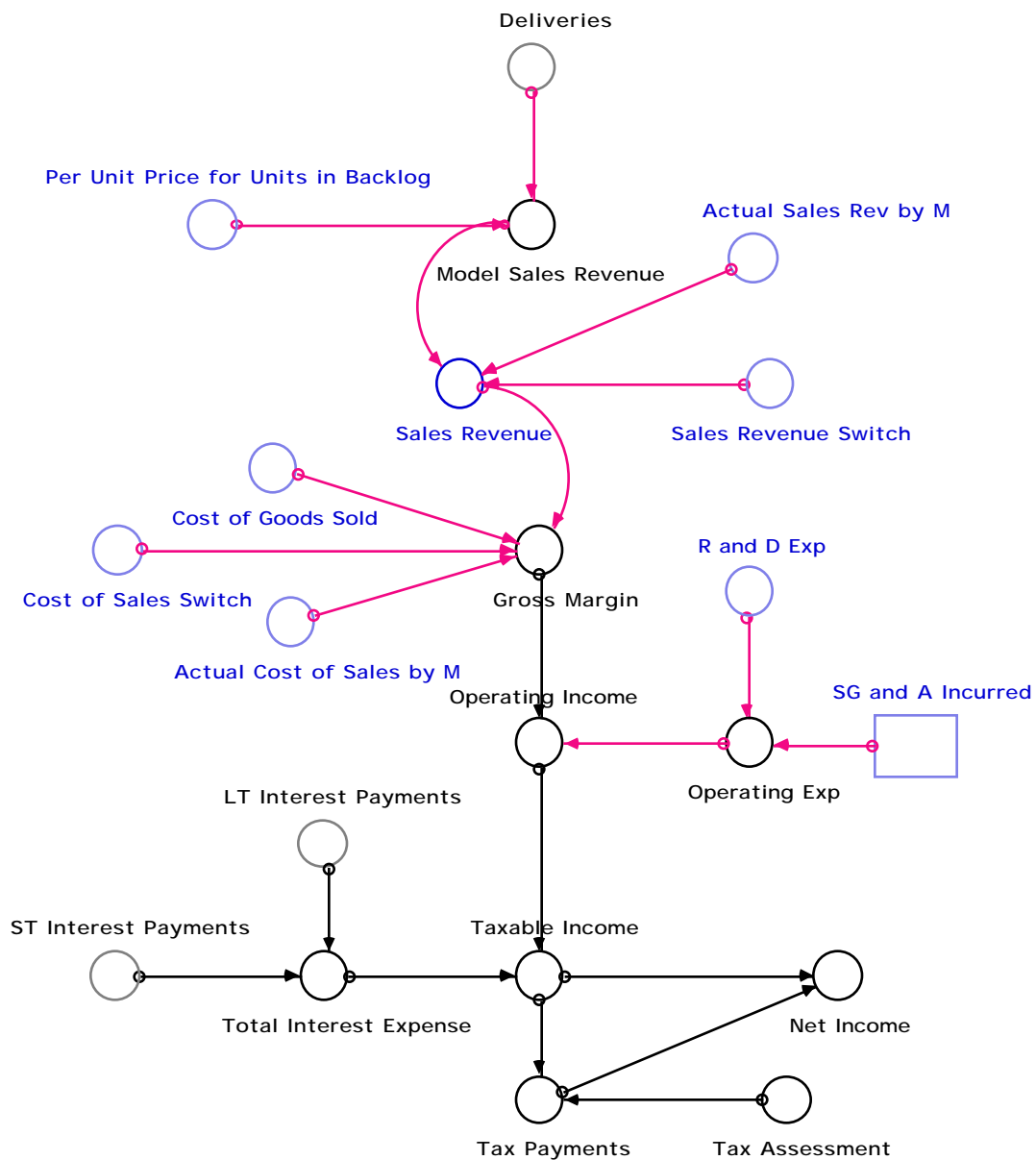

Sales revenue is equal to the rate of deliveries multiplied by the average price of units in the backlog. The gross margin is sales revenue minus the cost of goods sold. Operating income is equal to the gross margin minus current operating expenses. Operating expenses are equal to research and development expense plus sales, general and administrative expenses. Taxable incomes is operating income minus total interest expense, which is the sum of interest paid on both long and short term debt. Net income is equal to taxable income minus tax payments. Tax payments are calculated as taxable income multiplied by the current tax rate. The tax rate is assumed to be a constant 25% of taxable income based on information taken from Analog's annual reports [Analog Device 1985-1990].

432: $\text{Model_Sales_Revenue} = \text{Deliveries} * \text{Per_Unit_Price_for_Units_in_Backlog}$

DEFN: Model Sales Revenue

USES: Deliveries(150) Per_Unit_Price_for_Units_in_Backlog(420)

AFFX: Sales_Revenue(436) SRA_In(627)

UNITS: dollars/month

436: $\text{Sales_Revenue} = \text{Model_Sales_Revenue} * (1 - \text{Sales_Revenue_Switch}) + \text{Actual_Sales_Rev_by_M} * \text{Sales_Revenue_Switch}$

DEFN: Sales Revenue

USES: Actual_Sales_Rev_by_M(646) Model_Sales_Revenue(432) Sales_Revenue_Switch(666)

AFFX: Gen_and_Admin_Exp(346) Marketing_Exp(351) Selling_Exp(353) Gross_Margin(431)

Incr_in_Receivables(445) ExpRevenue(504) ChngExpRev(505) Actual_RD_Frac(508)

Revenue_Trend(514) Indicated_Annual_Sales_Revenue(537) OP_Income_as_Percent_of_Sales(540)

UNITS: dollars/month

431: $\text{Gross_Margin} = \text{Sales_Revenue} - ((\text{Cost_of_Goods_Sold} * (1 - \text{Cost_of_Sales_Switch})) + (\text{Actual_Cost_of_Sales_by_M} * \text{Cost_of_Sales_Switch}))$

DEFN: Gross Margin

USES: Actual_Cost_of_Sales_by_M(637) Cost_of_Goods_Sold(401) Cost_of_Sales_Switch(651) Sales_Revenue(436)

AFFX: Operating_Income(435) Per_Unit_Gross_margin(661)

UNITS: dollars/month

435: $\text{Operating_Income} = \text{Gross_Margin} - \text{Operating_Exp}$

DEFN: Operating Income

USES: Gross_Margin(431) Operating_Exp(434)

AFFX: Taxable_Income(437) Indicated_Annual_Operating_Income(536)

OP_Income_as_Percent_of_Sales(540) OIA_In(618) Per_Unit_Op_Income(663)

UNITS: dollars/month

434: $\text{Operating_Exp} = \text{SG_and_A_Incurred} + \text{R_and_D_Exp}$

DEFN: Operating Expenses

USES: R_and_D_Exp(13) SG_and_A_Incurred(342)

AFFX: Operating_Income(435) Accts_Payable_Increases(442) Per_Unit_Op_Exp(662)

UNITS: dollars/month

437: $\text{Taxable_Income} = \text{Operating_Income} - \text{Total_Interest_Expense}$

DEFN: Taxable Income
USES: Operating_Income(435) Total_Interest_Expense(440)
AFFX: Net_Income(433) Tax_Payments(439)
UNITS: dollars/month

439: Tax_Payments = Tax_Assessment*Taxable_Income

DEFN: Tax Payments
USES: Tax_Assessment(438) Taxable_Income(437)
AFFX: Net_Income(433) Cash_Out(449) Required_Cash_Payments(479)
UNITS: dollars/month

438: Tax_Assessment = .25

DEFN: Tax Assessment
AFFX: Tax_Payments(439)
UNITS: dimensionless

440: Total_Interest_Expense = (LT_Interest_Payments+ST_Interest_Payments)

DEFN: Total Interest Expense
USES: LT_Interest_Payments(468) ST_Interest_Payments(485)
AFFX: Taxable_Income(437)
UNITS: dollars/month

433: Net_Income = Taxable_Income-Tax_Payments

DEFN: Net Income
USES: Tax_Payments(439) Taxable_Income(437)
AFFX: Net_Cash_by_Operations(500) Retained_Period_Earnings(520) Earnings_per_Share(530)
Return_on_Capital(543) Return_on_Equity(544)
UNITS: dollars/month

8.2 Balance Sheet

8.2.1 Assets

8.2.1.1 Cash

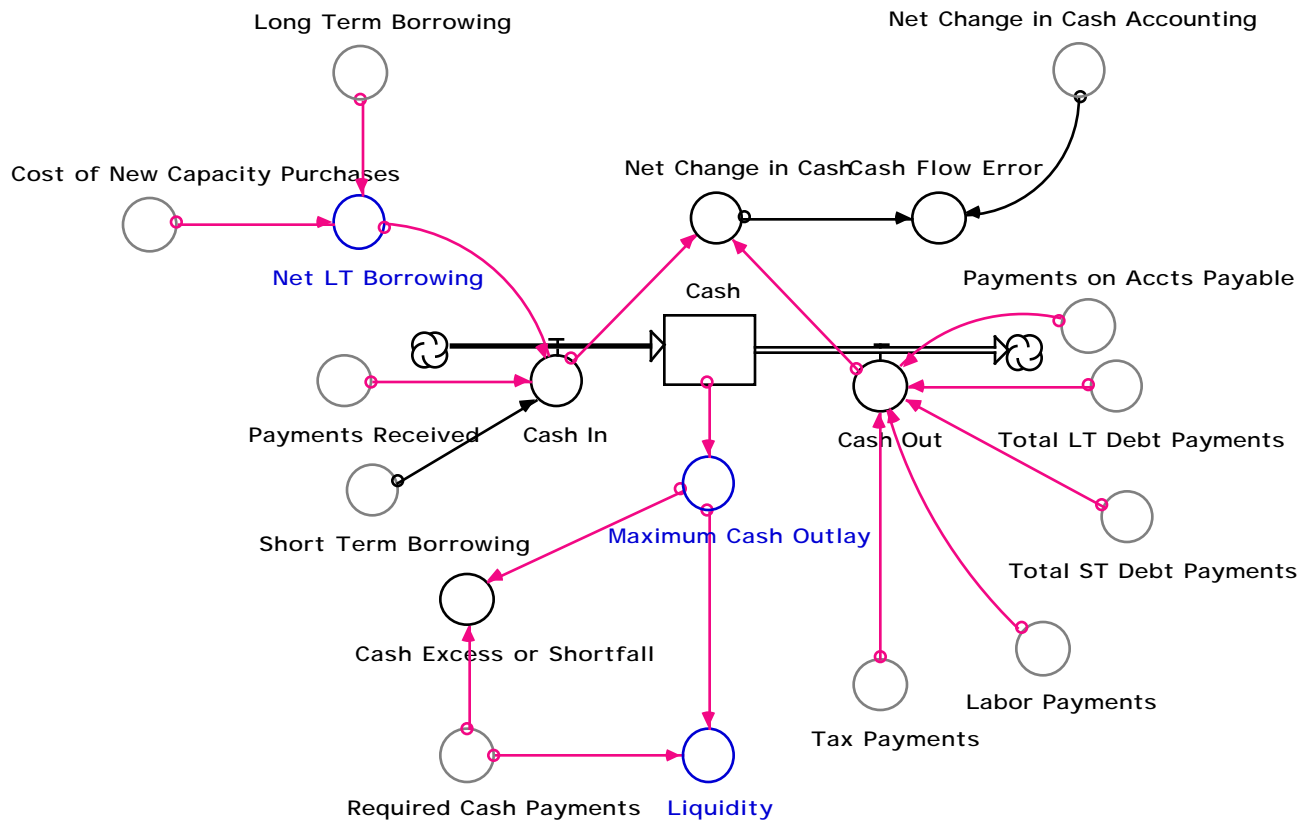

The firm's available stock of cash is increased by receipts and decreased by cash outlays. Cash inflows come from three sources: payment on accounts receivable, short term borrowing, and long term borrowing. In this model, long term borrowing is used solely for the purchase of capital while short term borrowing is used to meet any temporary cash shortfalls. Cash outlays include payments on short and long term debt, payments to labor, tax payments, and payments on accounts payable. The initial cash holding is based upon Analog's 1985 annual report [Analog Devices 1985].

447: $Cash = Cash * (t-dt) + (Cash_In - Cash_Out) * dt$
 INIT: 14e6

DEFN: Cash Holdings
 USES: Cash_In(448) Cash_Out(449)
 AFFX: Maximum_Cash_Outlay(470) Total_Current_Assets(489)
 UNITS: dollars

448: $Cash_In = Payments_Received + Short_Term_Borrowing + Net_LT_Borrowing$

DEFN: Increase in Cash Holdings

USES: Net_LT_Borrowing(477) Payments_Received(446) Short_Term_Borrowing(457)

AFFX: Cash(447) Net_Change_in_Cash(474)

UNITS: dollars/month

477: Net_LT_Borrowing = Long_Term_Borrowing-Cost_of_New_Capacity_Purchases

DEFN: Net Increase in Cash Due to Long Term Borrowing

USES: Cost_of_New_Capacity_Purchases(454) Long_Term_Borrowing(451)

AFFX: Cash_In(448)

UNITS: dollars/month

449: Cash_Out =

Labor_Payments+Tax_Payments+Total_ST_Dept_Payments+Total_LT_Dept_Payments+Payments_o
n_Accts_Payable

DEFN: Decrease in Cash Holdings

USES: Labor_Payments(350) Payments_on_Accts_Payable(443) Tax_Payments(439)

Total_LT_Dept_Payments(493) Total_ST_Dept_Payments(494)

AFFX: Cash(447) Net_Change_in_Cash(474)

UNITS: dollars/month

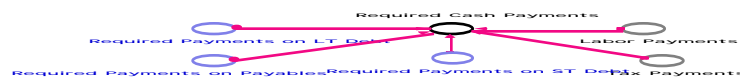

Liquidity is defined as the maximum cash outlay divided by the current rate of required cash payments. The current maximum cash outlay is equal to the current stock of cash divided by the time required to totally deplete cash reserves, here assumed to be one month. The current rate of required cash payments is equal to the sum of required payments on accounts payable, tax payments, labor payments, and payments required on long and short term debt. The cash excess or shortfall, used to determine whether additional short term borrowing is required, is calculated as the maximum cash outlay minus the required rate of cash payments. To reconcile the statement of cash flows the net change in cash is also calculated as total cash inflow minus total cash outlay.

470: Maximum_Cash_Outlay = Cash/1

DEFN: Maximum Cash Outlay

USES: Cash(447)

AFFX: Cash_Excess_or_Shortfall(463) Liquidity(467)

UNITS: dollars/month

467: Liquidity = Maximum_Cash_Outlay/Required_Cash_Payments

DEFN: Liquidity

USES: Maximum_Cash_Outlay(470) Required_Cash_Payments(479)

AFFX: Effect_of_Liquidity_on_Accts_Payable_Payments(496)

Effect_of_Liquidity_on_ST_Dept_Payment(497) Eff_of_Liquidity_on_LT_Dept_Payment(498)

UNITS: dimensionless

479: Required_Cash_Payments =
 Required_Payments_on_Payables+Tax_Payments+Labor_Payments+Required_Payments_on_LT_De
 bt+Required_Payments_on_ST_Debt

DEFN: Required Cash Payments

USES: Labor_Payments(350) Required_Payments_on_LT_Debt(481)

Required_Payments_on_Payables(482) Required_Payments_on_ST_Debt(483) Tax_Payments(439)

AFFX: Cash_Excess_or_Shortfall(463) Liquidity(467)

UNITS: dollars/month

463: Cash_Excess_or_Shortfall = Maximum_Cash_Outlay-Required_Cash_Payments

DEFN: Cash Excess or Shortfall

USES: Maximum_Cash_Outlay(470) Required_Cash_Payments(479)

AFFX: Short_Term_Borrowing(457)

UNITS: dollars/month

474: Net_Change_in_Cash = Cash_In-Cash_Out

DEFN: Net Change in Cash Holdings

USES: Cash_In(448) Cash_Out(449)

AFFX: Cash_Flow_Error(464)

UNITS: dollars/month

8.2.1.2 Accounts Receivable

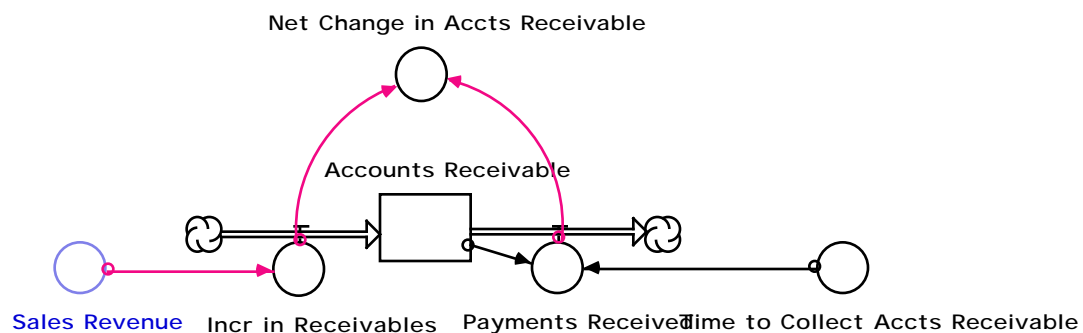

Accounts receivable are increased by new sales revenue and decreased by the receipt of payments. Payments are equal to the current level of receivables divided by the average time required to collect receivables, assumed to be three months. The initial value is based upon information taken from Analog's 1985 annual report [Analog Devices 1985]. The net change in receivables is calculated as the increase is receivables minus payments.

444: Accounts_Receivable = Accounts_Receivable *(t-dt) + (Incr_in_Receivables - Payments_Received)
 * dt

INIT: 23e6

DEFN: Accounts Receivable

USES: Incr_in_Receivables(445) Payments_Received(446)

AFFX: Payments_Received(446) Total_Current_Assets(489)

UNITS: dollars

445: $\text{Incr_in_Receivables} = \text{Sales_Revenue}$

DEFN: Increase in Accounts Receivable

USES: $\text{Sales_Revenue}(436)$

AFFX: $\text{Accounts_Receivable}(444)$ $\text{Net_Change_in_Accts_Receivable}(473)$

UNITS: dollars/month

446: $\text{Payments_Received} = \text{Accounts_Receivable} / \text{Time_to_Collect_Accts_Receivable}$

DEFN: Payments on Accounts Receivable Received

USES: $\text{Accounts_Receivable}(444)$ $\text{Time_to_Collect_Accts_Receivable}(487)$

AFFX: $\text{Accounts_Receivable}(444)$ $\text{Cash_In}(448)$ $\text{Net_Change_in_Accts_Receivable}(473)$

UNITS: dollars/month

487: $\text{Time_to_Collect_Accts_Receivable} = 3$

DEFN: Average Time Required to Collect Accounts Receivable

AFFX: $\text{Payments_Received}(446)$

UNITS: months

473: $\text{Net_Change_in_Accts_Receivable} = \text{Incr_in_Receivables} - \text{Payments_Received}$

DEFN: Net Change in Accounts Receivable

USES: $\text{Incr_in_Receivables}(445)$ $\text{Payments_Received}(446)$

AFFX: $\text{Net_Cash_by_Operations}(500)$

UNITS: dollars/month

8.2.1.3 Value of Inventory

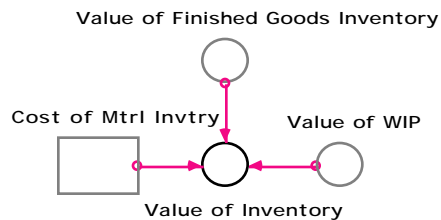

The total value of inventory is the sum of the values of material inventory, work in process, and finished goods inventory.

495: $\text{Value_of_Inventory} = \text{Value_of_Finished_Goods_Inventory} + \text{Value_of_WIP} + \text{Cost_of_Mtrl_Invtry}$

DEFN: Total Value of Inventory Holdings

USES: $\text{Cost_of_Mtrl_Invtry}(322)$ $\text{Value_of_Finished_Goods_Inventory}(406)$ $\text{Value_of_WIP}(407)$

AFFX: $\text{Total_Current_Assets}(489)$

UNITS: dollars

8.2.1.4 Capital Stock

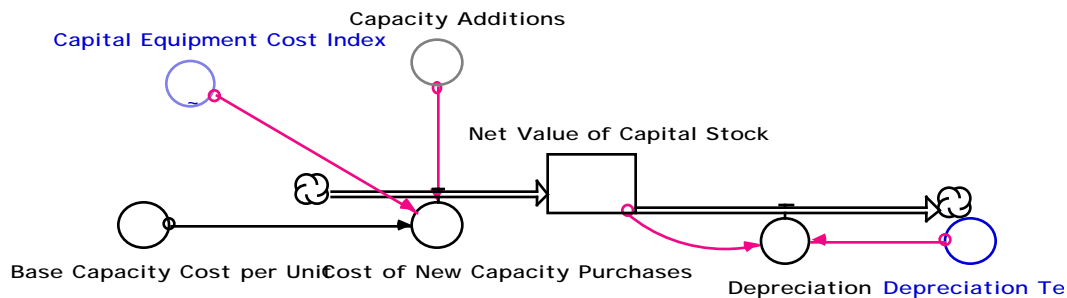

The net asset value of the capital stock is increased by the purchase of new capital and decreased by depreciation. Capital is assumed to be used until it is retired and can not be sold. The increase in value due to purchases is equal to the number of units purchased multiplied by the base cost per capital unit which is adjusted by a capital equipment cost index. The base cost per capital unit is assumed to be forty thousand dollars based upon the authors' estimate made during the calibration process. Depreciation is equal to the current value of the capital stock divided by the average depreciation term, set to ten years based on information taken from Analog annual reports [Analog Devices 1990].

453: $\text{Net_Value_of_Capital_Stock} = \text{Net_Value_of_Capital_Stock} * (t-dt) + (\text{Cost_of_New_Capacity_Purchases} - \text{Depreciation}) * dt$
 INIT: $\text{Capital} * \text{Base_Capacity_Cost_per_Unit} * .5$

DEFN: Net Value of Capital Holdings
 USES: Base_Capacity_Cost_per_Unit(462) Capital(186) Cost_of_New_Capacity_Purchases(454) Depreciation(455)
 AFFX: Depreciation(455) Total_Assets(488)
 UNITS: dollars

454: $\text{Cost_of_New_Capacity_Purchases} = \max(0, \text{Capacity_Additions}) * \text{Base_Capacity_Cost_per_Unit} * \text{Capital_Equipment_Cost_Index}$

DEFN: Cost of New Capacity Purchases
 USES: Base_Capacity_Cost_per_Unit(462) Capacity_Additions(187) Capacity_Additions(191) Capital_Equipment_Cost_Index(689)
 AFFX: Long_Term_Borrowing(451) Net_Value_of_Capital_Stock(453) Net_LT_Borrowing(477) Net_Change_in_Cash_Accounting(502)
 UNITS: dollars/month

462: $\text{Base_Capacity_Cost_per_Unit} = 40000$

DEFN: Base Cost per Capital Unit
 AFFX: Net_Value_of_Capital_Stock(453) Cost_of_New_Capacity_Purchases(454)
 UNITS: dollars

455: $\text{Depreciation} = \text{Net_Value_of_Capital_Stock} / \text{Depreciation_Term}$

DEFN: Depreciation of Capital Holdings
 USES: Depreciation_Term(466) Net_Value_of_Capital_Stock(453)

AFFX: Budgeted_Depreciation_Expense(356) Chng_in_Depr_Expense(357)
 Capital_Spending_Variance(374) Net_Value_of_Capital_Stock(453) Net_Cash_by_Operations(500)
 UNITS: dollars/month

466: Depreciation_Term = 120

DEFN: Average Depreciation Term
 AFFX: Depreciation(455)
 UNITS: months

8.2.1.5 Total Assets

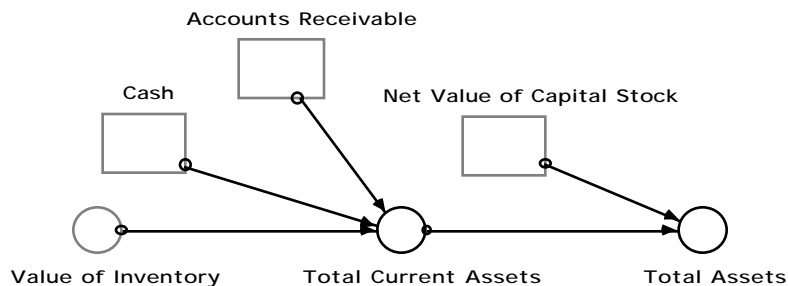

The total value of current assets is equal to the sum of cash holding, accounts receivable, and the value of inventory. The total value of assets is the sum of current assets and the net value of the capital stock.

489: Total_Current_Assets = Accounts_Receivable+Cash+Value_of_Inventory

DEFN: Total Value of Current Assets
 USES: Accounts_Receivable(444) Cash(447) Value_of_Inventory(495)
 AFFX: Total_Assets(488)
 UNITS: dollars

488: Total_Assets = (Net_Value_of_Capital_Stock)+Total_Current_Assets

DEFN: Total Value of Assets
 USES: Net_Value_of_Capital_Stock(453) Total_Current_Assets(489)
 AFFX: Balance_Sheet_Error(461) Paid_in_Capital(525) Breakout_Value_of_the_Firm(528)
 UNITS: dollars

8.2.2 Liabilities

8.2.2.1 Accounts Payable

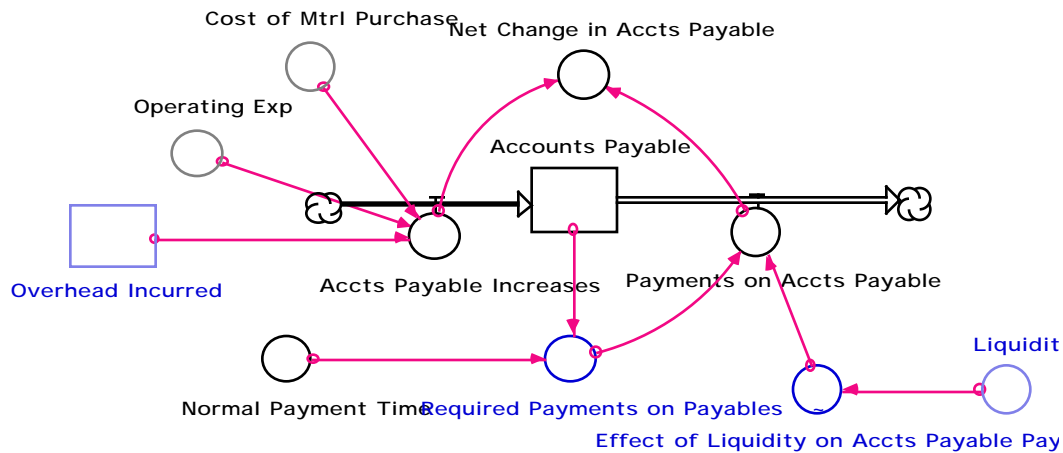

Accounts payable are increased by operating overhead and materials expense, and decreased by cash payments. The initial value is based upon information taken from Analog's 1985 annual report [Analog Devices 1985]. The required rate of payments on accounts payable is equal to the current level of accounts payable divided by the average payment time. The average payment time is assumed to be four months. Actual payments on accounts payable are equal to the rate of required payments multiplied by the effect of liquidity on the payment rate. In situations where cash reserves are low, the company will reduce its payment stream in an effort to conserve cash. For the purpose of reconciling the statement of cash flows, the net change in accounts receivable is calculated as the total increase minus payments.

441: $Accounts_Payable = Accounts_Payable \cdot (t-dt) + (Accts_Payable_Increases - Payments_on_Accts_Payable) \cdot dt$
 INIT: 55E6

DEFN: Accounts Payable

USES: Accts_Payable_Increases(442) Payments_on_Accts_Payable(443)

AFFX: Current_Liabilities(465) Required_Payments_on_Payables(482)

UNITS: dollars

442: $Accts_Payable_Increases = Cost_of_Mtrl_Purchase + Overhead_Incurred + Operating_Exp$

DEFN: Increase in Accounts Payable

USES: Cost_of_Mtrl_Purchase(323) Operating_Exp(434) Overhead_Incurred(339)

AFFX: Accounts_Payable(441) Net_Change_in_Accts_Payable(472)

UNITS: dollars/month

443: $Payments_on_Accts_Payable =$

$Required_Payments_on_Payables \cdot Effect_of_Liquidity_on_Accts_Payable_Payments$

DEFN: Payments on Accounts Payable
 USES: Effect_of_Liquidity_on_Accts_Payable_Payments(496)
 Required_Payments_on_Payables(482)
 AFFX: Accounts_Payable(441) Cash_Out(449) Net_Change_in_Accts_Payable(472)
 UNITS: dollars/month

482: $Required_Payments_on_Payables = Accounts_Payable / Normal_Payment_Time$

DEFN: Required Payments on Accounts Payable
 USES: Accounts_Payable(441) Normal_Payment_Time(478)
 AFFX: Payments_on_Accts_Payable(443) Required_Cash_Payments(479)
 UNITS: dollars/month

472: $Net_Change_in_Accts_Payable = Accts_Payable_Increases - Payments_on_Accts_Payable$

DEFN: Net Change in Accounts Payable
 USES: Accts_Payable_Increases(442) Payments_on_Accts_Payable(443)
 AFFX: Net_Cash_by_Operations(500)
 UNITS: dollars/month

478: $Normal_Payment_Time = 4$

DEFN: Average Time Required to Pay Accounts Payable
 AFFX: Required_Payments_on_Payables(482)
 UNITS: months

The effect of liquidity on the payment of accounts payable is operationalized as a non-linear function of liquidity, defined over the zero to one interval, that is strictly increasing with a second derivative that is initially positive and becomes negative at approximately the mid-point. As liquidity declines Analog will reduce its payment stream at an increasing rate. As liquidity approaches zero, so does the payment stream.

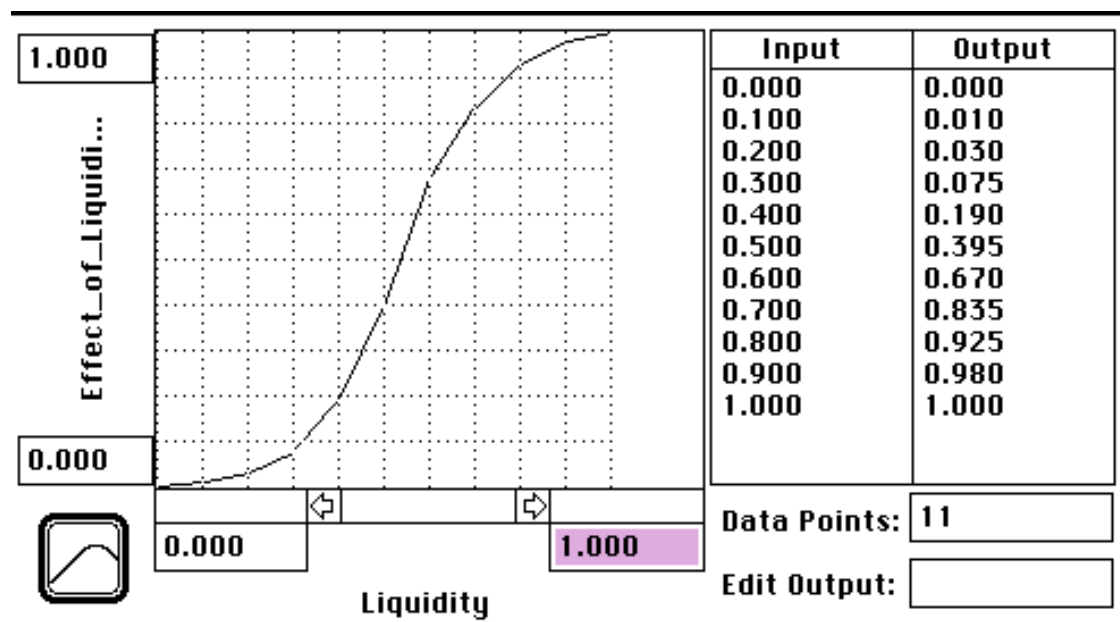

496: Effect_of_Liquidity_on_Accts_Payable_Payments = GRAPH(Liquidity)
 DATA: (0.00, 0.00), (0.1, 0.01), (0.2, 0.03), (0.3, 0.075), (0.4, 0.19), (0.5, 0.395), (0.6, 0.67), (0.7, 0.835), (0.8, 0.925), (0.9, 0.98), (1, 1.00)

DEFN: Effect of Liquidity on Payments on Accounts Payable

USES: Liquidity(467)

AFFX: Payments_on_Accts_Payable(443)

UNITS: dimensionless

8.2.2.2 Short Term Debt

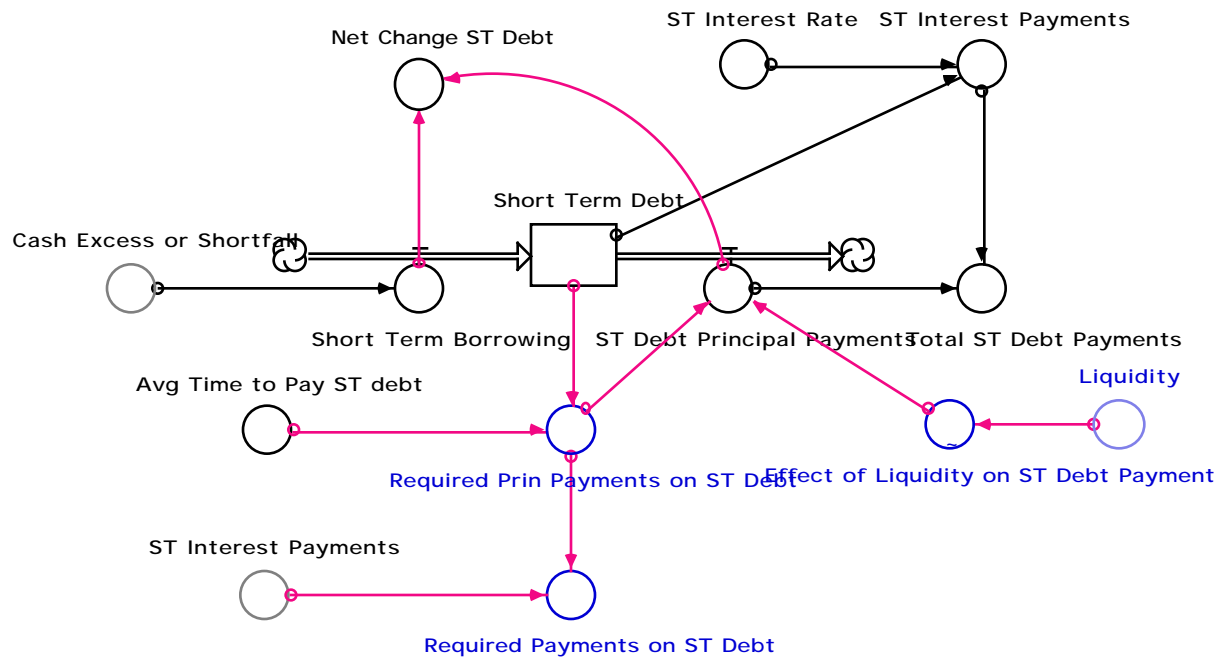

Short term borrowing is assumed to be used only for fulfilling obligations that can not be satisfied with available cash reserves. Outstanding short term debt is increased by a cash short fall and decreased by principle payments. Principal payments are determined by the required level of principal payments and the current liquidity. A decline in liquidity below one does not result in the reduction of the payment stream as Analog is assumed to always fulfill its short-term debt obligations. However, if liquidity is above one, Analog is assumed to increases its payments on short-term debt beyond the required rate. Required principal payments are equal to the short term debt outstanding divided by the average debt term, assumed to be twelve months. The initial value of ten million dollars is based upon data taken from Analog's 1985 annual report [Analog Devices 1985].

456: Short_Term_Debt = Short_Term_Debt *(t-dt) + (Short_Term_Borrowing - ST_Debt_Principal_Payments) * dt
 INIT: 10e6

DEFN: Outstanding Short Term Debt
 USES: Short_Term_Borrowing(457) ST_Debt_Principal_Payments(458)
 AFFX: Current_Liabilities(465) Required_Prin_Payments_on_ST_Debt(484)
 ST_Interest_Payments(485) Total_Employed_Capital(490)
 UNITS: dollars

457: Short_Term_Borrowing = MAX(-Cash_Excess_or_Shortfall,0)

DEFN: Increase in Short Term Debt Through Borrowing
 USES: Cash_Excess_or_Shortfall(463)
 AFFX: Cash_In(448) Short_Term_Debt(456) Net_Change_ST_Debt(476)
 UNITS: dollars/month

458: ST_Debt_Principal_Payments =
 Required_Prin_Payments_on_ST_Debt*Effect_of_Liquidity_on_ST_Debt_Payment

DEFN: Principal Payments on Outstanding Short Term Debt
 USES: Effect_of_Liquidity_on_ST_Debt_Payment(497) Required_Prin_Payments_on_ST_Debt(484)
 AFFX: Short_Term_Debt(456) Net_Change_ST_Debt(476) Total_ST_Debt_Payments(494)
 UNITS: dollars/month

484: Required_Prin_Payments_on_ST_Debt = Short_Term_Debt/Avg_Time_to_Pay_ST_debt

DEFN: Required Principal Payments on Short Term Debt
 USES: Avg_Time_to_Pay_ST_debt(460) Short_Term_Debt(456)
 AFFX: ST_Debt_Principal_Payments(458) Required_Payments_on_ST_Debt(483)
 UNITS: dollars/month

460: Avg_Time_to_Pay_ST_debt = 12

DEFN: Average Time Required to Pay Short Term Debt
 AFFX: Required_Prin_Payments_on_ST_Debt(484)
 UNITS: months

The effect of liquidity on short term debt principal payments is assumed to be a non-linear function such that when liquidity is less than one actual payments equal required payments unless liquidity is very close to zero. When liquidity is above one the function is increasing and concave. This represents the assumption that Analog always attempts to fulfill its short term debt obligations regardless of liquidity concerns, and if excess cash begins to accumulate Analog will reduce its short-term obligations.

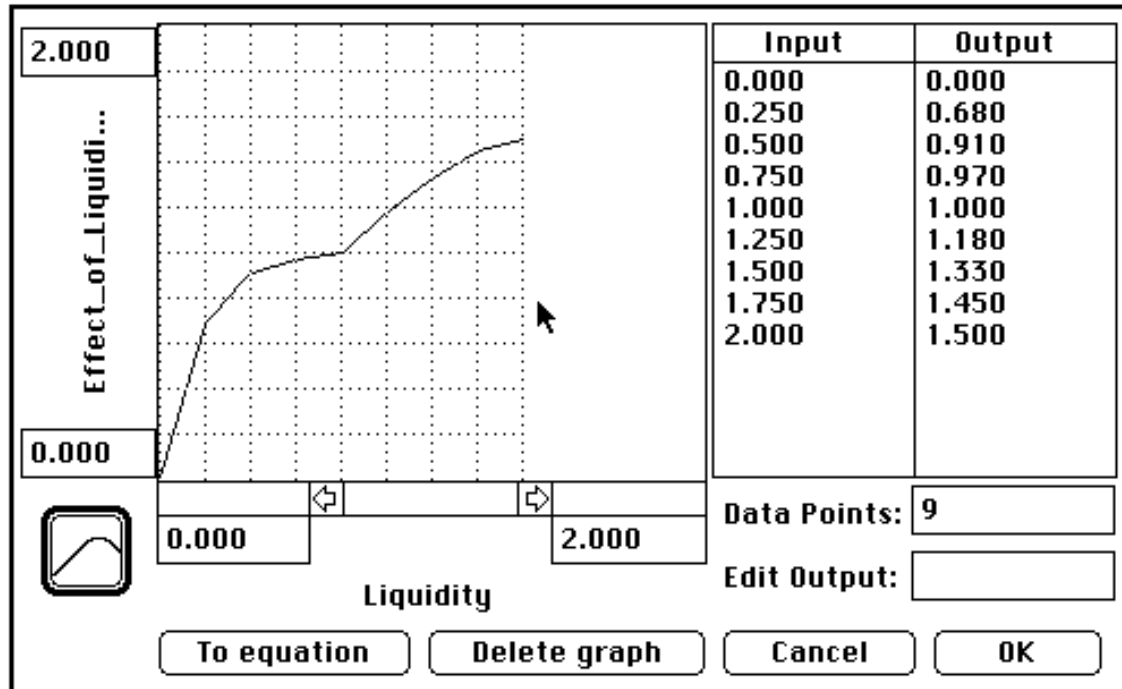

497: Effect_of_Liquidity_on_ST_Debt_Payment = GRAPH(Liquidity)
 DATA: (0.00, 0.00), (0.25, .68), (0.5, .91), (0.75, .97), (1.00, 1.00), (1.25, 1.18), (1.50, 1.33), (1.75, 1.45), (2.00, 1.50)

DEFN: Effect of Liquidity on Payments on Short Term Debt
 USES: Liquidity(467)
 AFFX: ST_Debt_Principal_Payments(458)
 UNITS: dimensionless

Interest payments on short term debt are equal to the current level of short term debt multiplied by the short term interest rate. The short term interest rate is assumed to be .0025 per month which is equivalent to an annual rate of three percent. The net change in short term debt is also calculated for cash flow reconciliation purposes.

485: ST_Interest_Payments = ST_Interest_Rate*Short_Term_Debt

DEFN: Interest Payments on Short Term Debt
 USES: Short_Term_Debt(456) ST_Interest_Rate(486)
 AFFX: Total_Interest_Expense(440) Required_Payments_on_ST_Debt(483)
 Total_ST_Debt_Payments(494)
 UNITS: dollars/month

486: ST_Interest_Rate = .0025

DEFN: Interest Rate for Short Term Debt
 AFFX: ST_Interest_Payments(485)
 UNITS: 1/months

$$494: \text{Total_ST_Debt_Payments} = \text{ST_Debt_Principal_Payments} + \text{ST_Interest_Payments}$$

DEFN: Total Payments on Short Term Debt
 USES: ST_Debt_Principal_Payments(458) ST_Interest_Payments(485)
 AFFX: Cash_Out(449)
 UNITS: dollars/month

$$483: \text{Required_Payments_on_ST_Debt} = \text{Required_Prin_Payments_on_ST_Debt} + \text{ST_Interest_Payments}$$

DEFN: Required Payments on Short Term Debt
 USES: Required_Prin_Payments_on_ST_Debt(484) ST_Interest_Payments(485)
 AFFX: Required_Cash_Payments(479)
 UNITS: dollars/month

$$476: \text{Net_Change_ST_Debt} = \text{Short_Term_Borrowing} - \text{ST_Debt_Principal_Payments}$$

DEFN: Net Change in Outstanding Short Term Debt
 USES: Short_Term_Borrowing(457) ST_Debt_Principal_Payments(458)
 AFFX: Net_Cash_from_Finance(501)
 UNITS: dollars/month

8.2.2.3 Long Term Debt

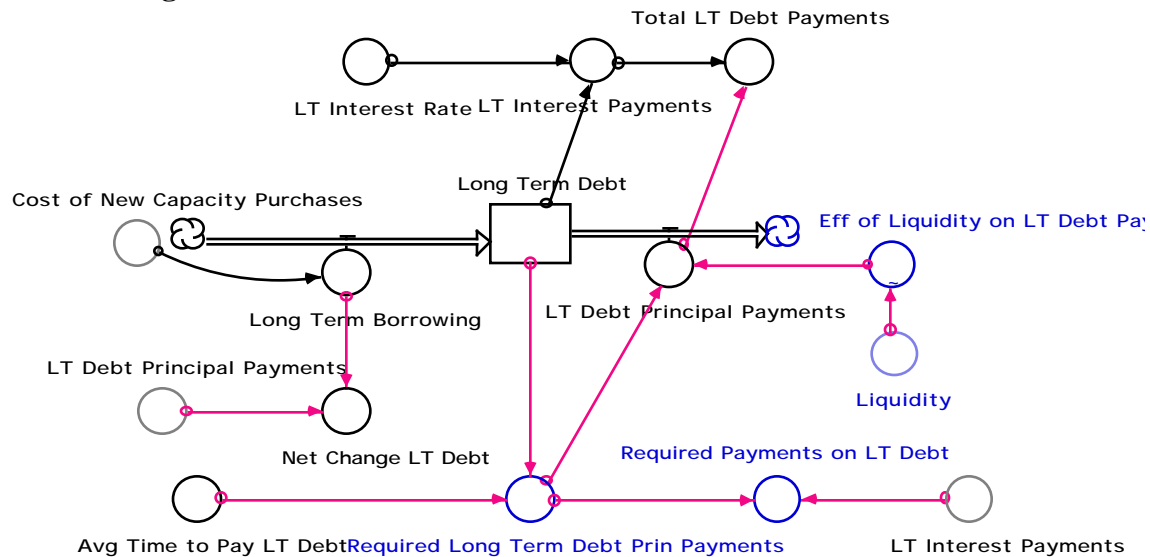

All capital purchases are assumed to be financed with long term debt. As a result, long term debt is increased by the current unit capacity cost each time a new unit of capital is purchased and is decreased each time principal payments are made. Principal payments are a function of the required rate of principal payments, the current debt level divided by the average payment period, and the current liquidity. The average maturity period is assumed to be sixty months based on information taken from Analog annual reports. The initial value is based upon data taken from the 1985 Analog annual report [Analog Devices 1985].

450: $Long_Term_Debt = Long_Term_Debt * (t-dt) + (Long_Term_Borrowing - LT_Debt_Principal_Payments) * dt$
 INIT: 35e6

DEFN: Outstanding Long Term Debt
 USES: Long_Term_Borrowing(451) LT_Debt_Principal_Payments(452)
 AFFX: LT_Interest_Payments(468) Required_Long_Term_Dept_Prin_Payments(480)
 Total_Employed_Capital(490) Total_Liabilities(491)
 UNITS: dollars

451: $Long_Term_Borrowing = Cost_of_New_Capacity_Purchases$

DEFN: Increase in Long Term Debt Due to Borrowing
 USES: Cost_of_New_Capacity_Purchases(454)
 AFFX: Long_Term_Dept(450) Net_Change_LT_Dept(475) Net_LT_Borrowing(477)
 UNITS: dollars/month

452: $LT_Debt_Principal_Payments = Required_Long_Term_Dept_Prin_Payments * Eff_of_Liquidity_on_LT_Debt_Payment$

DEFN: Principal Payments on Outstand Long Term Debt
 USES: Eff_of_Liquidity_on_LT_Dept_Payment(498)
 Required_Long_Term_Dept_Prin_Payments(480)
 AFFX: Long_Term_Dept(450) Net_Change_LT_Dept(475) Total_LT_Dept_Payments(493)
 UNITS: dollars/month

480: $Required_Long_Term_Dept_Prin_Payments = Long_Term_Debt / Avg_Time_to_Pay_LT_Debt$

DEFN: Required Principal Payments on Long Term Debt
 USES: Avg_Time_to_Pay_LT_Dept(459) Long_Term_Dept(450)
 AFFX: LT_Dept_Principal_Payments(452) Required_Payments_on_LT_Dept(481)
 UNITS: dollars/month

459: $Avg_Time_to_Pay_LT_Debt = 60$

DEFN: Average Term on Long Term Debt
 AFFX: Required_Long_Term_Dept_Prin_Payments(480)
 UNITS: months

The effect of liquidity on long-term debt payments is assumed to be a non-linear function, defined over the interval zero to two, that is increasing with a second derivative that is initially positive and becomes negative at the mid-point which is at (1.00,1.00). Low liquidity causes Analog to slow the repayment of long term debt. When liquidity equals zero, payment necessarily stops. When liquidity exceeds unity, repayment of long term debt is accelerated by as much as twice the normal rate.

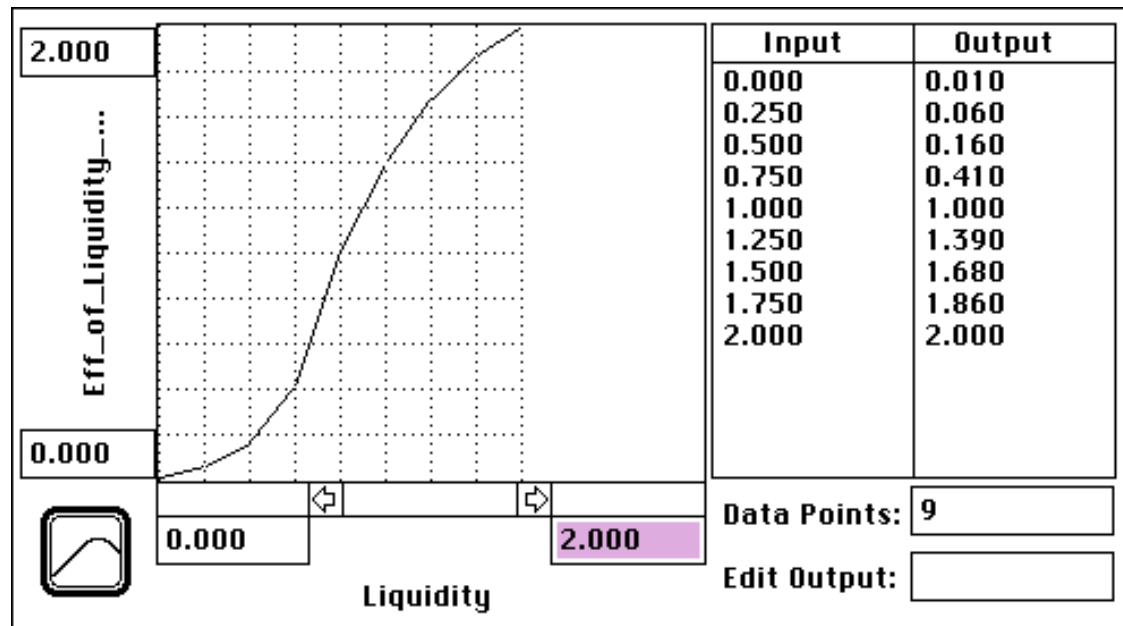

498: Eff_of_Liquidity_on_LT_Dept_Payment = GRAPH(Liquidity)
 DATA: (0.00, 0.01), (0.25, 0.06), (0.5, 0.16), (0.75, 0.41), (1.00, 1.00), (1.25, 1.39), (1.50, 1.68), (1.75, 1.86), (2.00, 2.00)

DEFN: Effect of Liquidity on Long Term Debt
 USES: Liquidity(467)
 AFFX: LT_Dept_Principal_Payments(452)
 UNITS: dimensionless

Interest payments on the outstanding long term debt are equal to the current debt level multiplied by the long term interest rate. The monthly long term interest rate is set to .56% which corresponds to an annual rate of 7%. The value was chosen based information found in Analog annual reports [Analog Devices 1990]. The total required payment rate on long term debt is equal to the sum of interest payments and required principal payments, while the actual payment rate is the sum of the interest payments and the actual principal payments. The net change in the level of long term debt is also calculated.

468: LT_Interest_Payments = Long_Term_Debt*LT_Interest_Rate

DEFN: Interest Payments on Long Term Debt
 USES: Long_Term_Debt(450) LT_Interest_Rate(469)
 AFFX: Total_Interest_Expense(440) Required_Payments_on_LT_Dept(481)
 Total_LT_Dept_Payments(493)
 UNITS: dollars/month

469: LT_Interest_Rate = .0056

DEFN: Interest Rate for Long Term Debt
 AFFX: LT_Interest_Payments(468)
 UNITS: 1/months

481: $\text{Required_Payments_on_LT_Debt} = \text{LT_Interest_Payments} + \text{Required_Long_Term_Debt_Prin_Payments}$

DEFN: Required Payments on Long Term Debt

USES: $\text{LT_Interest_Payments}(468)$ $\text{Required_Long_Term_Debt_Prin_Payments}(480)$

AFFX: $\text{Required_Cash_Payments}(479)$

UNITS: dollars/month

493: $\text{Total_LT_Debt_Payments} = \text{LT_Debt_Principal_Payments} + \text{LT_Interest_Payments}$

DEFN: Total Payments on Long Term Debt

USES: $\text{LT_Debt_Principal_Payments}(452)$ $\text{LT_Interest_Payments}(468)$

AFFX: $\text{Cash_Out}(449)$

UNITS: dollars/month

475: $\text{Net_Change_LT_Debt} = \text{Long_Term_Borrowing} - \text{LT_Debt_Principal_Payments}$

DEFN: Net Change in Outstanding Long Term Debt

USES: $\text{Long_Term_Borrowing}(451)$ $\text{LT_Debt_Principal_Payments}(452)$

AFFX: $\text{Net_Cash_from_Finance}(501)$

UNITS: dollars/month

8.2.3 Equity

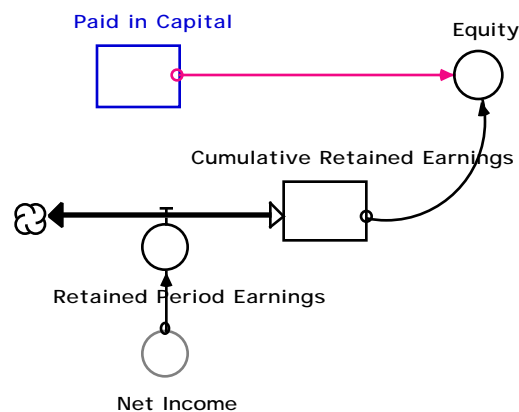

The owner's equity is assumed to be comprised of two components, paid in capital and cumulative retained earnings. Paid in capital is assumed to be constant and its initial value is algebraically chosen so that assets and liabilities plus owner's equity are equal. Cumulative retained earnings is equal to the lifetime sum of the company's retained period earnings which is, in turn, equal to the net period income. The initial value is set to 125 million dollars based upon the value at the beginning of 1985 as reported in the 1985 Analog annual report [Analog Devices 1985].

525: $\text{Paid_in_Capital} = \text{Paid_in_Capital}$

INIT: $\text{Total_Assets} - \text{Total_Liabilities} - \text{Cumulative_Retained_Earnings}$

DEFN: Paid in Capital

USES: $\text{Cumulative_Retained_Earnings}(519)$ $\text{Total_Assets}(488)$ $\text{Total_Liabilities}(491)$

AFFX: $\text{Equity}(531)$

UNITS: dollars

519: $Cumulative_Retained_Earnings = Cumulative_Retained_Earnings * (t-dt) + (Retained_Period_Earnings) * dt$
 INIT: 125e6

DEFN: Cumulative Retained Earnings
 USES: Retained_Period_Earnings(520)
 AFFX: Paid_in_Capital(525) Equity(531)
 UNITS: dollars

520: $Retained_Period_Earnings = Net_Income$

DEFN: Retained Period Earnings
 USES: Net_Income(433)
 AFFX: Cumulative_Retained_Earnings(519)
 UNITS: dollars/month

531: $Equity = Cumulative_Retained_Earnings + Paid_in_Capital$

DEFN: Owner's Equity
 USES: Cumulative_Retained_Earnings(519) Paid_in_Capital(525)
 AFFX: Total_Employed_Capital(490) Total_Liabilities_and_Equity(492) Equity_per_Share(532)
 Return_on_Equity(544)
 UNITS: dollars

8.2.4 Total Liabilities and Equity

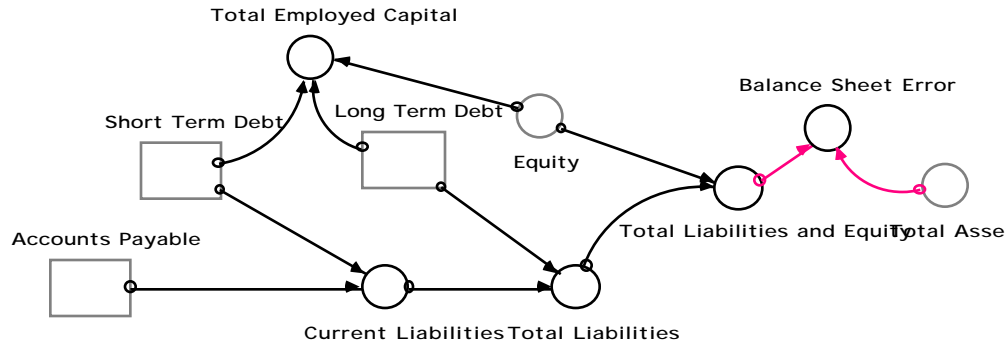

The level of total current liabilities is equal to the sum of accounts payable and the level of short term debt. The level of total liabilities is equal to the sum of current liabilities and the outstanding long term debt, while the level of total capital currently employed equals the sum of short term debt, long term debt and owner's equity. The balance sheet error, if any, is calculated as total assets minus total liabilities and equity.

465: $Current_Liabilities = Accounts_Payable + Short_Term_Debt$

DEFN: Current Liabilities
 USES: Accounts_Payable(441) Short_Term_Debt(456)
 AFFX: Total_Liabilities(491)
 UNITS: dollars

491: $Total_Liabilities = Long_Term_Debt + Current_Liabilities$

DEFN: Total Liabilities

USES: Current_Liabilities(465) Long_Term_Debt(450)

AFFX: Total_Liabilities_and_Equity(492) Paid_in_Capital(525) Breakout_Value_of_the_Firm(528)

UNITS: dollars

492: $Total_Liabilities_and_Equity = Equity + Total_Liabilities$

DEFN: Total Liabilities and Equity

USES: Equity(531) Total_Liabilities(491)

AFFX: Balance_Sheet_Error(461)

UNITS: dollars

490: $Total_Employed_Capital = Short_Term_Debt + Long_Term_Debt + Equity$

DEFN: Total Employed Capital

USES: Equity(531) Long_Term_Debt(450) Short_Term_Debt(456)

AFFX: Return_on_Capital(543)

UNITS: dollars

461: $Balance_Sheet_Error = Total_Assets - Total_Liabilities_and_Equity$

DEFN: Balance Sheet Error

USES: Total_Assets(488) Total_Liabilities_and_Equity(492)

UNITS: dollars

8.3 Cash Flow Statement

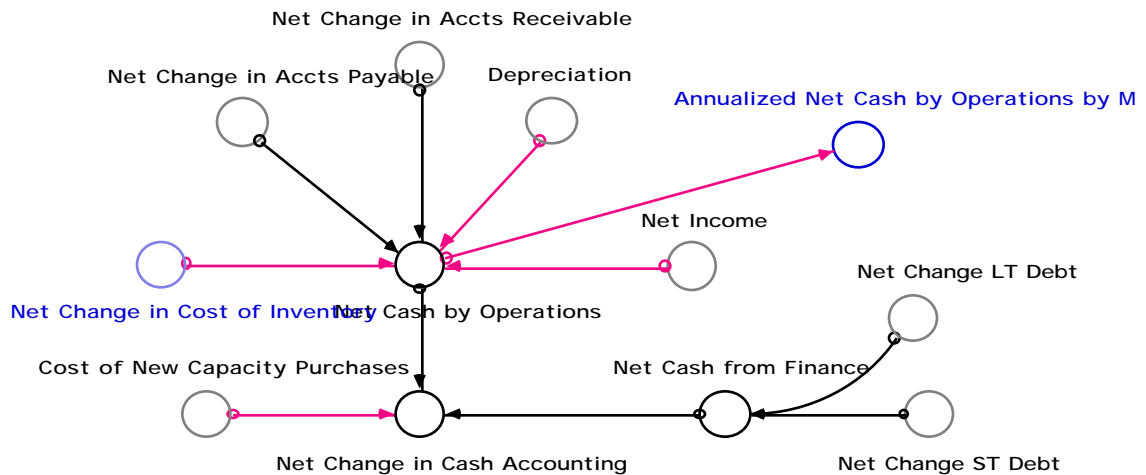

The statement of cash flows determines the total net cash generated or lost by the company each period. The net cash flow generated by operations is calculated as the sum of net income, depreciation, and the net change in accounts receivable, minus the sum of the net change in accounts payable and the net change in the cost of inventory.

500: $\text{Net_Cash_by_Operations} = (\text{Net_Income} + \text{Depreciation} + \text{Net_Change_in_Accts_Payable} - \text{Net_Change_in_Accts_Receivable} - \text{Net_Change_in_Cost_of_Inventory})$

DEFN: Net Cash Generated by Operations

USES: Depreciation(455) Net_Change_in_Accts_Payable(472)

Net_Change_in_Accts_Receivable(473) Net_Change_in_Cost_of_Inventory(503) Net_Income(433)

AFFX: Annualized_Net_Cash_by_Operations_by_M(499) Net_Change_in_Cash_Accounting(502)

Cash_Flow_In(612)

UNITS: dollars/month

The net cash flow generated by financing activities is equal to the net change in outstanding short and long term debt. The net change in cash generated by the company is equal to the sum of net cash flow generated by operations and the net cash flow generated by finance minus the cost of any capital investment.

501: $\text{Net_Cash_from_Finance} = (\text{Net_Change_LT_Debt} + \text{Net_Change_ST_Debt})$

DEFN: Net Cash Flow Generated by Financing Activities

USES: Net_Change_LT_Debt(475) Net_Change_ST_Debt(476)

AFFX: Net_Change_in_Cash_Accounting(502)

UNITS: dollars/month

502: $\text{Net_Change_in_Cash_Accounting} = (\text{Net_Cash_by_Operations} + \text{Net_Cash_from_Finance}) - \text{Cost_of_New_Capacity_Purchases}$

DEFN: Net Change in Cash Flow

USES: $\text{Cost_of_New_Capacity_Purchases}(454)$ $\text{Net_Cash_by_Operations}(500)$

$\text{Net_Cash_from_Finance}(501)$

AFFX: $\text{Cash_Flow_Error}(464)$

UNITS: dollars/month

464: $\text{Cash_Flow_Error} = \text{Net_Change_in_Cash} - \text{Net_Change_in_Cash_Accounting}$

DEFN: Error in Statement of Cash Flows

USES: $\text{Net_Change_in_Cash}(474)$ $\text{Net_Change_in_Cash_Accounting}(502)$

UNITS: dollars/month

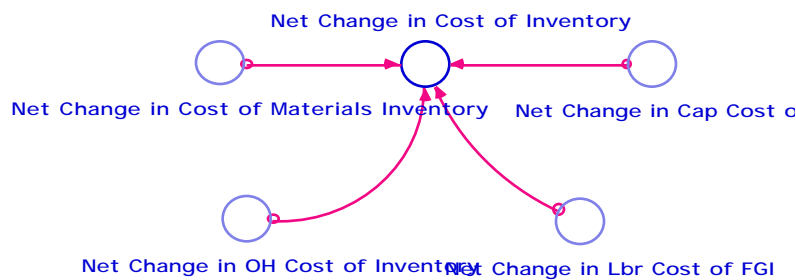

The net total change in the cost of inventory is equal to the sum of the net change in the cost of each individual inventory cost category.

503: $\text{Net_Change_in_Cost_of_Inventory} =$

$\text{Net_Change_in_Cost_of_Materials_Inventory} + \text{Net_Change_in_OH_Cost_of_Inventory} + \text{Net_Change_in_Cap_Cost_of_FGI} + \text{Net_Change_in_Lbr_Cost_of_FGI}$

DEFN: Net Change in the Value of Inventory

USES: $\text{Net_Change_in_Cap_Cost_of_FGI}(396)$ $\text{Net_Change_in_Cost_of_Materials_Inventory}(337)$

$\text{Net_Change_in_Lbr_Cost_of_FGI}(397)$ $\text{Net_Change_in_OH_Cost_of_Inventory}(398)$

AFFX: $\text{Net_Cash_by_Operations}(500)$

UNITS: dollars/month

9.0 R and D Budgeting

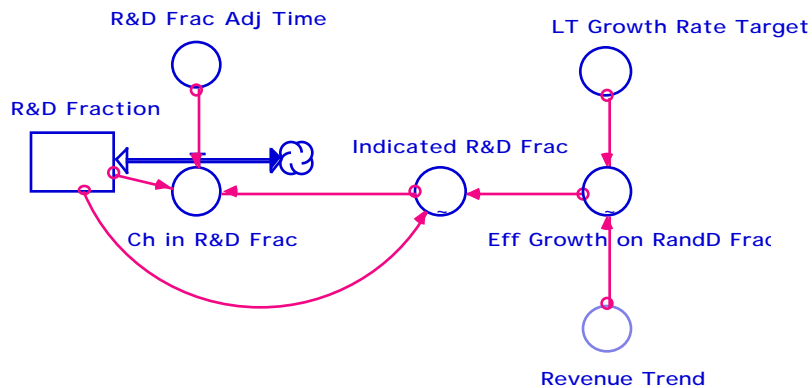

Research and development spending is a function of the forecasted sales revenue multiplied by the fraction that management chooses to allocate to the research and development effort. The actual fraction of sales revenue allocated to R&D is an exponentially weighted average of the fraction indicated by the current trend in revenue and the company's long run target for growth. The time constant is assumed to be three months. The delay represents the time required for management to react to changes in revenue growth and to adjust R&D budgets accordingly.

506: $R\&D_Fraction = R\&D_Fraction * (t-dt) + (Ch_in_R\&D_Frac) * dt$
 INIT: .08

DEFN: Fraction of Sales Revenue Allocated to Research and Development
 USES: Ch_in_R&D_Frac(507)
 AFFX: Ch_in_R&D_Frac(507) Model_R_and_D_Exp(512) Indicated_R&D_Frac(518)
 UNITS: dimensionless

507: $Ch_in_R\&D_Frac = (Indicated_R\&D_Frac - R\&D_Fraction) / R\&D_Frac_Adj_Time$

DEFN: Change in the Fraction of Sales Revenue Allocated to Research and Development
 USES: Indicated_R&D_Frac(518) R&D_Frac_Adj_Time(513) R&D_Fraction(506)
 AFFX: R&D_Fraction(506)
 UNITS: 1/months

513: $R\&D_Frac_Adj_Time = 3$

DEFN: Average Time Required for Adjustment in the Fraction of Sales Revenue Allocated to Research and Development
 AFFX: Ch_in_R&D_Frac(507)
 UNITS: months

The indicated R&D fraction represents the fraction of expected revenue the firm should be allocating to research and development based upon the historical fraction and modified by the gap between the expected and target rate of revenue growth. The formulation assumes that management sets the R&D budget based upon an anchoring and adjustment heuristic: they anchor on the current R&D fraction and adjust based upon the gap between the expected and actual growth

in sales revenue. The indicated R&D fraction is a non-linear function of the current R&D fraction multiplied by the effect of the revenue growth gap. The function is linear for values of the independent variable below 1.25, but saturates at 16% of revenues.

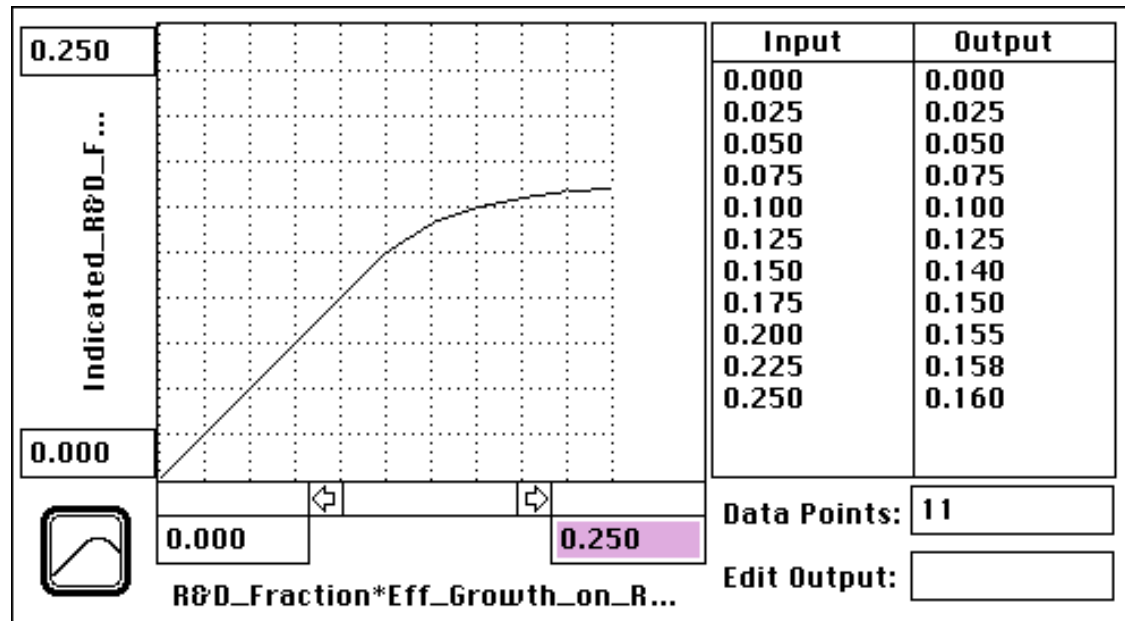

518: Indicated_R&D_Frac = GRAPH(R&D_Fraction*Eff_Growth_on_RandD_Frac)
 DATA: (0.00, 0.00), (0.025, 0.025), (0.05, 0.05), (0.075, 0.075), (0.1, 0.1), (0.125, 0.125), (0.15, 0.14), (0.175, 0.15), (0.2, 0.155), (0.225, 0.158), (0.25, 0.16)

DEFN: Indicated Fraction of Sales Revenue to Allocated to Research and Development
 USES: Eff_Growth_on_RandD_Frac(517) R&D_Fraction(506)
 AFFX: Ch_in_R&D_Frac(507)
 UNITS: dimensionless

The indicated R&D fraction is adjusted by a non-linear function of the gap between the target revenue growth rate and the recent actual revenue growth rate. When the growth rate equal the target there is no change in the indicated R&D fraction. When growth falls below the target the R&D fraction is increased up to a maximum of 20%. If growth exceeds the target, then the R&D fraction is cut back to as much as 87% of its current value. Thus, slow growth stimulates R&D spending, while excessive growth leads to a decline in R&D as a fraction of sales revenue.

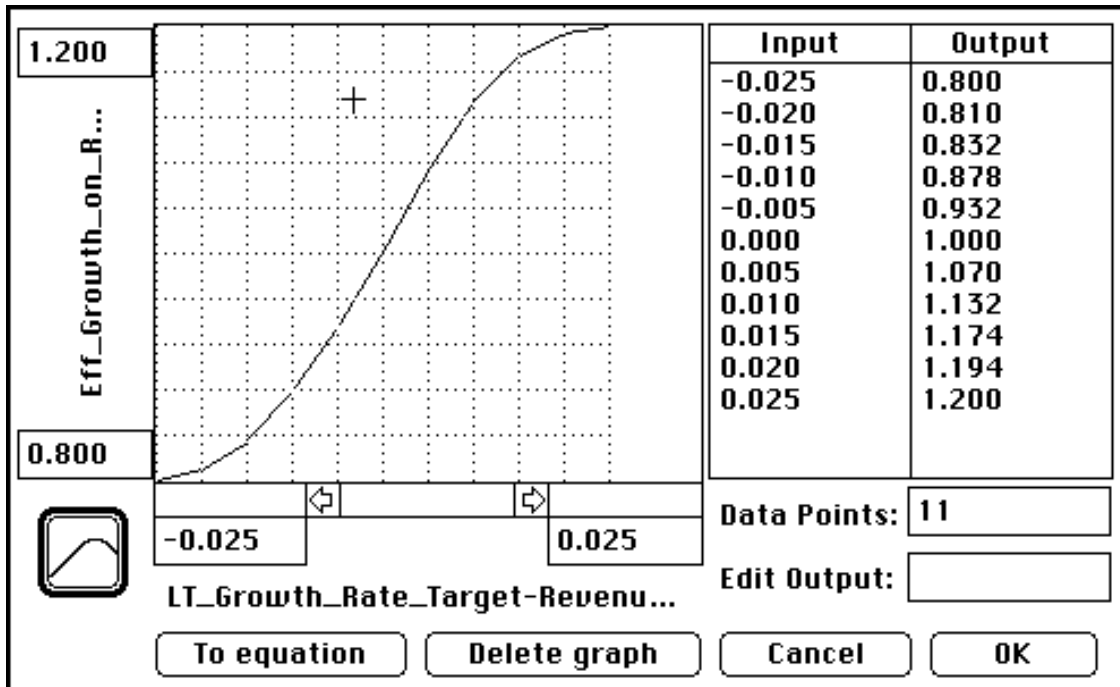

517: Eff_Growth_on_RandD_Frac = GRAPH(LT_Growth_Rate_Target-Revenue_Trend)
 DATA: (-0.025, 0.80), (-0.02, 0.81), (-0.015, 0.83), (-0.01, 0.88), (-0.005, 0.943), (0, 1.00), (0.005, 1.07), (0.01, 1.32), (0.015, 1.17), (0.02, 1.19), (0.025, 1.20)

DEFN: Effect of Growth on the Fraction of Sales Revenue Allocated to Research and Development
 USES: LT_Growth_Rate_Target(511) Revenue_Trend(514)
 AFFX: Indicated_R&D_Frac(518)
 UNITS: dimensionless

511: LT_Growth_Rate_Target = .02

DEFN: Target Growth Rate for Monthly Sales Revenue
 AFFX: Eff_Growth_on_RandD_Frac(517)
 UNITS: dimensionless

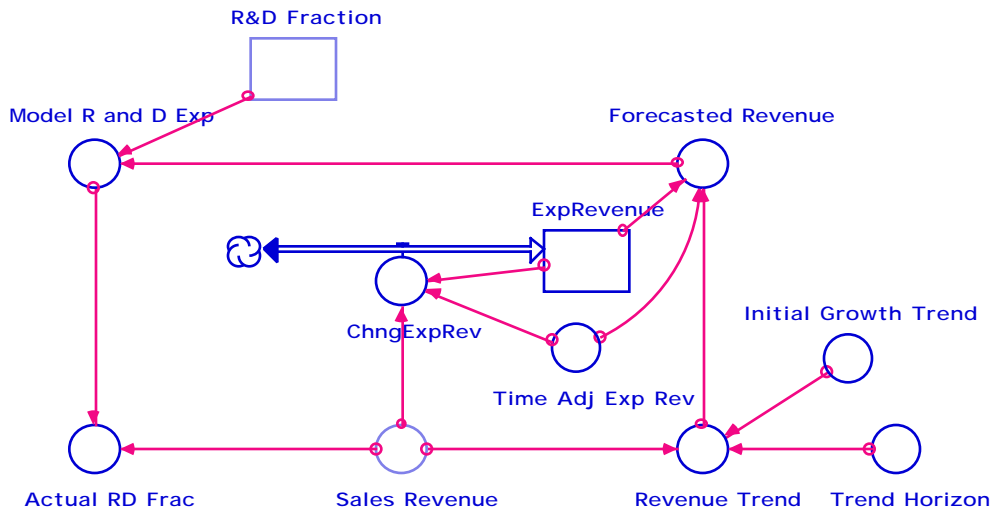

The forecasted revenue level is equal to average revenue level corrected for any trend [Sberman 1988 1987]. The expected revenue level is determined adaptively using a first order exponentially weighted average with an assumed time constant of twelve months. The growth trend is calculated using the TREND function built in to iThink software and described in the user's guide. The trend is calculated over a four year horizon with an initial value of 2% growth per month. This is equivalent to an annual rate of approximately 25% which was Analog's historical growth rate through the early 1980's.

509: $\text{Forecasted_Revenue} = \text{ExpRevenue} * (1 + \text{Revenue_Trend} * \text{Time_Adj_Exp_Rev})$

DEFN: Forecasted Sales Revenue

USES: ExpRevenue(504) Revenue_Trend(514) Time_Adj_Exp_Rev(515)

AFFX: Model_R_and_D_Exp(512)

UNITS: dollars/month

504: $\text{ExpRevenue} = \text{ExpRevenue} * (t - dt) + (\text{ChngExpRev}) * dt$

INIT: $\text{Sales_Revenue} / (1 + \text{Revenue_Trend} * \text{Time_Adj_Exp_Rev})$

DEFN: Expected Sales Revenue

USES: ChngExpRev(505) Revenue_Trend(514) Sales_Revenue(436) Time_Adj_Exp_Rev(515)

AFFX: ChngExpRev(505) Forecasted_Revenue(509)

UNITS: dollars/month

505: $\text{ChngExpRev} = (\text{Sales_Revenue} - \text{ExpRevenue}) / \text{Time_Adj_Exp_Rev}$

DEFN: Change in the Expected Sales Revenue

USES: ExpRevenue(504) Sales_Revenue(436) Time_Adj_Exp_Rev(515)

AFFX: ExpRevenue(504)

UNITS: dollars/month/month

515: $\text{Time_Adj_Exp_Rev} = 12$

DEFN: Average Time Required to Adjust the Expected Sales Revenue

AFFX: ExpRevenue(504) ChngExpRev(505) Forecasted_Revenue(509)

UNITS: months

514: $\text{Revenue_Trend} = \text{TREND}(\text{Sales_Revenue}, \text{Trend_Horizon}, \text{Initial_Growth_Trend})$

DEFN: Growth Trend in Sales Revenue

USES: Initial_Growth_Trend(510) Sales_Revenue(436) Trend_Horizon(516)

AFFX: ExpRevenue(504) Forecasted_Revenue(509) Eff_Growth_on_RandD_Frac(517)

UNITS: 1/months

510: $\text{Initial_Growth_Trend} = .02$

DEFN: Initial Condition for Growth Trend

AFFX: Revenue_Trend(514)

UNITS: 1/months

516: $\text{Trend_Horizon} = 48$

DEFN: Horizon for Calculating Growth Trend
AFFX: Revenue_Trend(514)
UNITS: months

512: Model_R_and_D_Exp = R&D_Fraction*Forecasted_Revenue

DEFN: Endogenously Generated Expense on Research and Development
USES: Forecasted_Revenue(509) R&D_Fraction(506)
AFFX: R_and_D_Exp(13) Actual_RD_Frac(508) RADA_In_(624)
UNITS: dollars/month

508: Actual_RD_Frac = Model_R_and_D_Exp/Sales_Revenue

DEFN: Analog's Historical Research and Development Fraction
USES: Model_R_and_D_Exp(512) Sales_Revenue(436)
UNITS: dimensionless

10. Stock Market

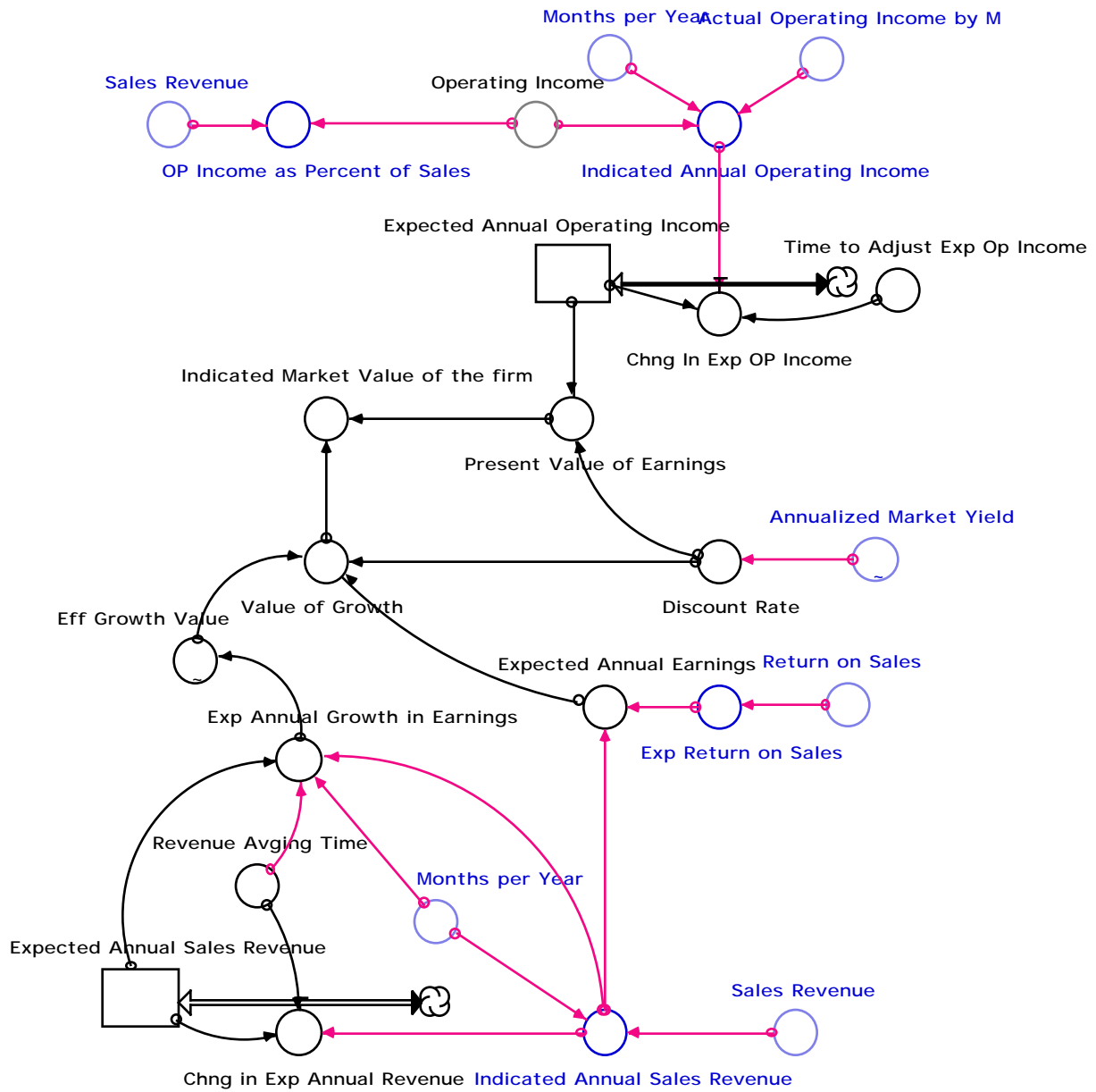

This section of the model determines Analog's market value based upon the discounted present value of the earning stream evaluated at the current level of operating income plus an adjustment for the perceived growth rate. Expected annual operating income is a first order exponentially

weighted average of the indicated annual operating income. The indicated annual operating income is equal to the current, monthly, operating income multiplied by twelve. The time constant for this process is thirty-six months based on the assumption that market analysts look back at least three years when evaluating Analog's market value. The discounted present value of the future earning stream is given by the current annual operating income divided by the discount rate. The discount rate is set equal to the annualized market yield of the Standard and Poors 500.

521: $\text{Expected_Annual_Operating_Income} = \text{Expected_Annual_Operating_Income} * (t-dt) + (\text{Chng_In_Exp_OP_Income}) * dt$
 INIT: $\text{Actual_Operating_Income_by_M} * \text{Months_per_Year}$

DEFN: Expected Annual Operating Income
 USES: $\text{Actual_Operating_Income_by_M}(642)$ $\text{Chng_In_Exp_OP_Income}(522)$ $\text{Months_per_Year}(657)$
 AFFX: $\text{Chng_In_Exp_OP_Income}(522)$ $\text{Present_Value_of_Earnings}(542)$
 UNITS: dollars/year

522: $\text{Chng_In_Exp_OP_Income} = (\text{Indicated_Annual_Operating_Income} - \text{Expected_Annual_Operating_Income}) / \text{Time_to_Adjust_Exp_Op_Income}$

DEFN: Change in the Expected Annual Operating Income
 USES: $\text{Expected_Annual_Operating_Income}(521)$ $\text{Indicated_Annual_Operating_Income}(536)$
 $\text{Time_to_Adjust_Exp_Op_Income}(547)$
 AFFX: $\text{Expected_Annual_Operating_Income}(521)$
 UNITS: dollars/year/month

536: $\text{Indicated_Annual_Operating_Income} = (((\text{Actual_Operating_Income_by_M}) * \text{Operating_Income_Switch}) + (\text{Operating_Income} * (1 - \text{Operating_Income_Switch}))) * \text{Months_per_Year}$

DEFN: Indicated Annual Operating Income
 USES: $\text{Actual_Operating_Income_by_M}(642)$ $\text{Months_per_Year}(657)$ $\text{Operating_Income}(435)$
 $\text{Operating_Income_Switch}(659)$
 AFFX: $\text{Chng_In_Exp_OP_Income}(522)$
 UNITS: dollars/year

547: $\text{Time_to_Adjust_Exp_Op_Income} = 3$

DEFN: Average Time Required to Adjust Expected Annual Operating Income
 AFFX: $\text{Chng_In_Exp_OP_Income}(522)$
 UNITS: months

542: $\text{Present_Value_of_Earnings} = \text{Expected_Annual_Operating_Income} / \text{Discount_Rate}$

DEFN: Discounted Present Value of Future Earnings
 USES: $\text{Discount_Rate}(529)$ $\text{Expected_Annual_Operating_Income}(521)$
 AFFX: $\text{Indicated_Market_Value_of_the_firm}(538)$
 UNITS: dollars

529: $\text{Discount_Rate} = \text{Annualized_Market_Yield}$

DEFN: Discount Rate
 USES: $\text{Annualized_Market_Yield}(688)$
 AFFX: $\text{Present_Value_of_Earnings}(542)$ $\text{Value_of_Growth}(548)$
 UNITS: 1/months

The expected growth rate in earnings is determined using the TREND procedure applied to sales revenue [Sternman 1988 1987]. Sales revenue, rather than operating income, is chosen as the primary input since it tends to exhibit less random noise, and, as a result, the underlying growth trend is easier to discern. For the TREND procedure the expected annual sales revenue is first calculated as a first order exponentially weighted average of the indicated annual sales revenue. The indicated annual sales revenue is equal to the current, monthly, sales revenue multiplied by twelve. The time constant for this process is twenty-four months.

523: $\text{Expected_Annual_Sales_Revenue} = \text{Expected_Annual_Sales_Revenue} * (t-dt) + (\text{Chng_in_Exp_Annual_Revenue}) * dt$
 INIT: $\text{Indicated_Annual_Sales_Revenue} / (1 + .05 * \text{Revenue_Avging_Time} / \text{Months_per_Year})$

DEFN: Expected Annual Sales Revenue
 USES: Chng_in_Exp_Annual_Revenue(524) Indicated_Annual_Sales_Revenue(537)
 Months_per_Year(657) Revenue_Avging_Time(545)
 AFFX: Chng_in_Exp_Annual_Revenue(524) Exp_Annual_Growth_in_Earnings(534)
 UNITS: dollars/year

524: $\text{Chng_in_Exp_Annual_Revenue} = (\text{Indicated_Annual_Sales_Revenue} - \text{Expected_Annual_Sales_Revenue}) / \text{Revenue_Avging_Time}$

DEFN: Change in the Expected Annual Sales Revenue
 USES: Expected_Annual_Sales_Revenue(523) Indicated_Annual_Sales_Revenue(537)
 Revenue_Avging_Time(545)
 AFFX: Expected_Annual_Sales_Revenue(523)
 UNITS: dollars/year/month

537: $\text{Indicated_Annual_Sales_Revenue} = \text{Sales_Revenue} * \text{Months_per_Year}$

DEFN: Indicated Annual Sales Revenue
 USES: Months_per_Year(657) Sales_Revenue(436)
 AFFX: Expected_Annual_Sales_Revenue(523) Chng_in_Exp_Annual_Revenue(524)
 Expected_Annual_Earnings(533) Exp_Annual_Growth_in_Earnings(534)
 UNITS: dollars/year

545: $\text{Revenue_Avging_Time} = 24$

DEFN: Average Time Required to Adjust Expected Sales Revenue
 AFFX: Expected_Annual_Sales_Revenue(523) Chng_in_Exp_Annual_Revenue(524)
 Exp_Annual_Growth_in_Earnings(534)
 UNITS: months

The expected annual growth rate in sales revenue is then calculated as the difference between the indicated and expected annual sales revenue divided by the expected sales revenue. The growth rate is also divided by the smoothing time constant so that the growth rate is measured on an annual basis. The expected percentage return on sales is assumed to be an exponentially weighted average of the perceived operating income calculated as a percentage of sales revenue. Perceived operating income as a percent of sales is an exponentially weighted average of the actual value,

with the delay representing the time required for the information to be reported, the ratio calculated, and the results communicated. Expected annual earnings is calculated as the indicated annual sales revenue multiplied by the expected return on sales. The value of growth is then calculated as the expected rate of annual earnings divided by the discount rate multiplied by a non-linear function of the current growth rate. This function is strictly convex, and lies everywhere below the 45 degree line, the line where the effect of growth rate equals the current growth rate. This non-linear weighting reflects that for small growth rates, those close to zero, analyst are not likely to consider the company a "growth stock" and thus will value it close to the discounted value of current earnings. However, as the growth rate increases, the company is more likely to be placed in the category of "growth stocks" and, thus, raise the companies valuation.

534: $\text{Exp_Annual_Growth_in_Earnings} = (\text{Indicated_Annual_Sales_Revenue} - \text{Expected_Annual_Sales_Revenue}) / (\text{Expected_Annual_Sales_Revenue} * (\text{Revenue_Avging_Time} / \text{Months_per_Year}))$

DEFN: Expected Annual Growth in Earnings

USES: Expected_Annual_Sales_Revenue(523) Indicated_Annual_Sales_Revenue(537)

Months_per_Year(657) Revenue_Avging_Time(545)

AFFX: Eff_Growth_Value(550)

UNITS: 1/months

535: $\text{Exp_Return_on_Sales} = \text{SMTH1}(\text{OP_Income_as_Percent_of_Sales}, 12)$

DEFN: Expected Reterun on Sales

USES: OP_Income_as_Percent_of_Sales(540)

AFFX: Expected_Annual_Earnings(533)

UNITS: dimensionless

540: $\text{OP_Income_as_Percent_of_Sales} = \text{SMTH1}(\text{Operating_Income}/\text{Sales_Revenue}, 3)$

DEFN: Operating Income as a Percent of Sales Revenue

USES: Operating_Income(435) Sales_Revenue(436)

AFFX: Efc_of_Op_Income_vs_Sales_on_Valuation(549) Historical_OI_as_Pct(555)

Effect_of_OI_on_FS(563)

UNITS: dimensionless

533: $\text{Expected_Annual_Earnings} = \text{Indicated_Annual_Sales_Revenue} * \text{Exp_Return_on_Sales}$

DEFN: Expected Annual Earnings

USES: Exp_Return_on_Sales(535) Indicated_Annual_Sales_Revenue(537)

AFFX: Value_of_Growth(548)

UNITS: dollars/year

548: $\text{Value_of_Growth} = (\text{Expected_Annual_Earnings} * \text{Eff_Growth_Value}) / \text{Discount_Rate}$

DEFN: Value of Growth

USES: Discount_Rate(529) Eff_Growth_Value(550) Expected_Annual_Earnings(533)

AFFX: Indicated_Market_Value_of_the_firm(538)

UNITS: dollars

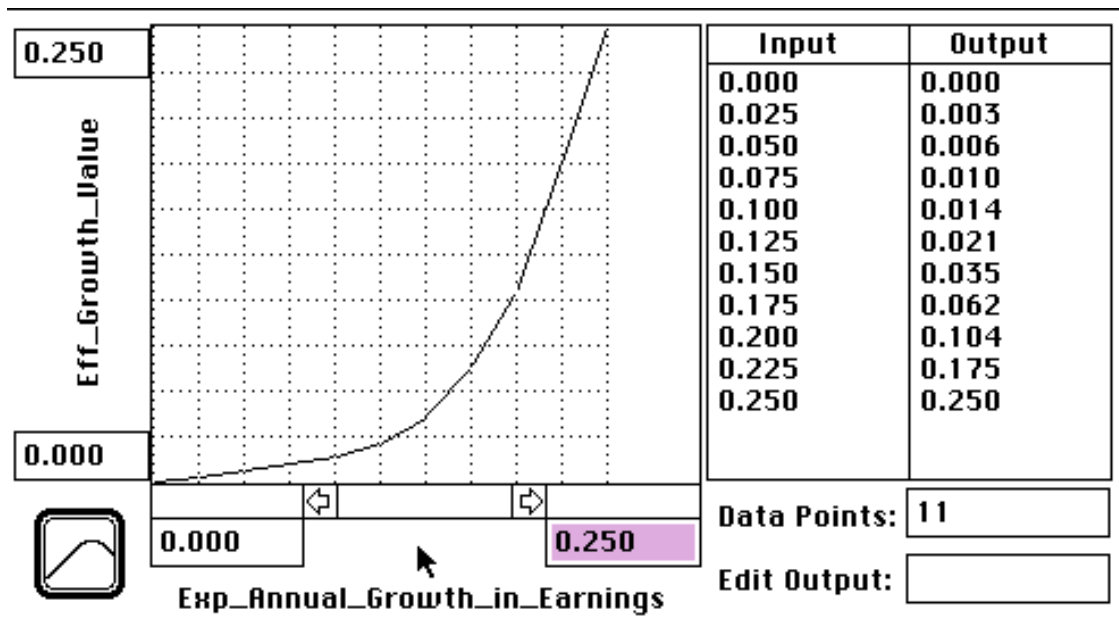

550: Eff_Growth_Value = GRAPH(Exp_Annual_Growth_in_Earnings)
 DATA: (-0.00, 0.00), (0.025, 0.0025), (0.05, 0.00625), (0.075, 0.01), (0.1, 0.0138), (0.125, 0.0213), (0.15, 0.035), (0.175, 0.0625), (0.2, 0.104), (0.225, 0.175), (0.25, 0.25)

DEFN: The Effect of Growth on Market Value
 USES: Exp_Annual_Growth_in_Earnings(534)
 AFFX: Value_of_Growth(548)
 UNITS: dimensionless

The indicated market value of the firm is then calculated as the sum of the discounted present value of earnings and the value of growth. The break-up value of the firm is determined as total assets minus total liabilities.

538: Indicated_Market_Value_of_the_firm = Max(Value_of_Growth+Present_Value_of_Earnings,0)

DEFN: Indicated Market Value of the Firm
 USES: Present_Value_of_Earnings(542) Value_of_Growth(548)
 AFFX: Analyst_Valuation_of_Analog(527)
 UNITS: dollars

528: Breakout_Value_of_the_Firm = (Total_Assets-Total_Liabilities)

DEFN: Break-out Value of the Firm
 USES: Total_Assets(488) Total_Liabilities(491)
 UNITS: dollars

526: Actual_Mrkt_Value = Shares_Outstanding*Actual_Avg_Share_Price_by_Q

DEFN: Actual Market Value of Analog
 USES: Actual_Avg_Share_Price_by_Q(669) Shares_Outstanding(551)
 AFFX: Actual_Years_Cash_Flow_to_Purchase(554) Model_Years_Cash_Flow_to_Purchase(558)
 Actual_Market_Value_to_Cash_Flow(639)
 UNITS: dollars

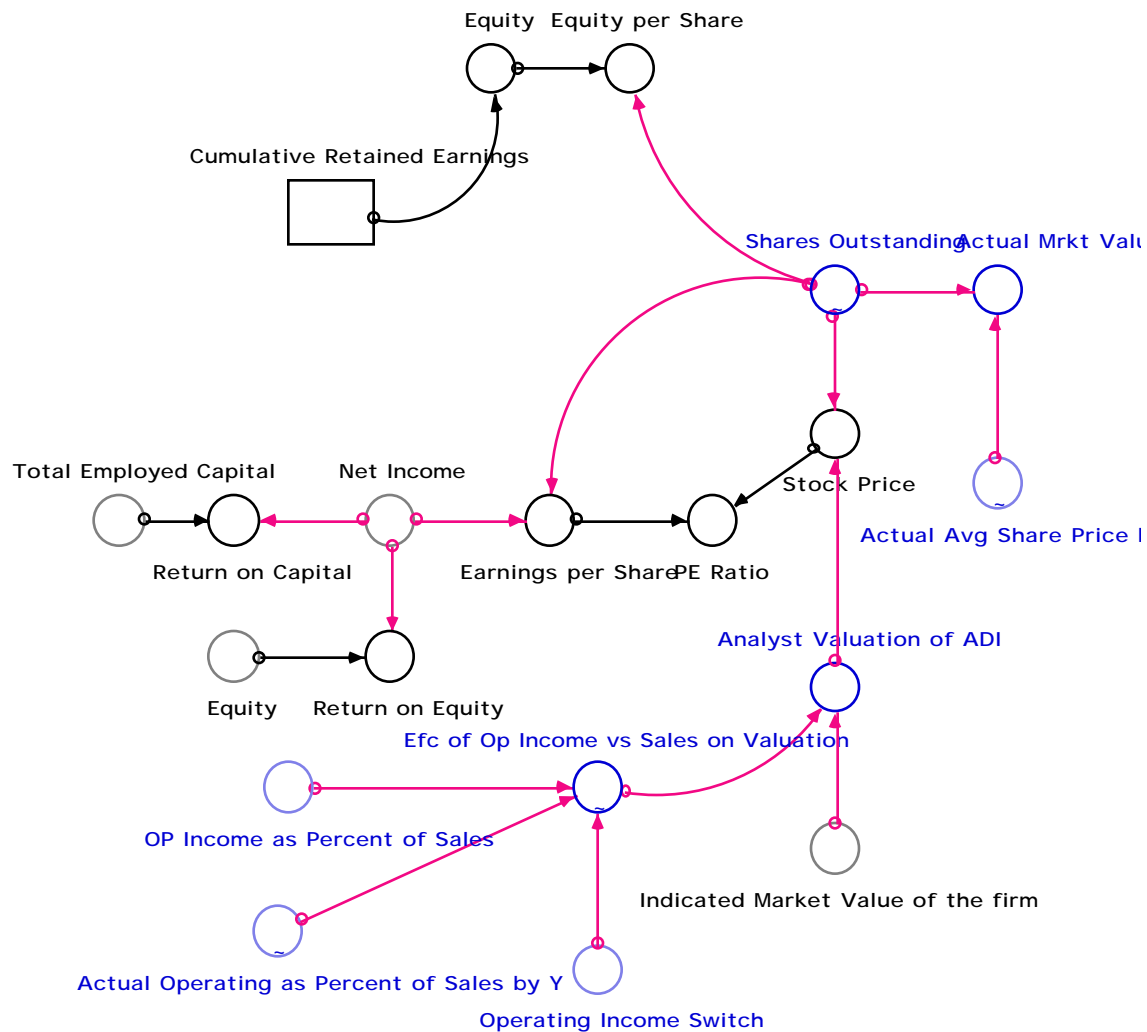

Analog's actual market valuation is equal to the indicated market valuation multiplied by a non-linear function of operating income calculated as a percent of total sales. This function is bounded below by 50% and above by 100%. It is everywhere weakly increasing and the second derivative changes from a positive to negative value as the input ranges from zero to 20%. The purpose of this function is to represent the effect of the analyst's perception of a company's ability to control costs on the valuation given to the company. A normal return is assumed to be 10% or above. From 1981 to 1990 Analog's operating return only fell below this value twice. If the return falls below this normal level, then analysts are assumed to believe that the company does not have

control of its cost structure and that the company should be valued at a level lower than the indicated level. There is substantial evidence to support the existence of this phenomenon [see Value Line 1991a 1991b 1992].

527: Analyst_Valuation_of_Analog =
Indicated_Market_Value_of_the_firm*Efc_of_Op_Income_vs_Sales_on_Valuation

DEFN: Analyst's Valuation of Analog

USES: Efc_of_Op_Income_vs_Sales_on_Valuation(549) Indicated_Market_Value_of_the_firm(538)

AFFX: Market_Value_to_Cash_Flow(539) Stock_Price(546)

Model_Years_Cash_Flow_to_Purchase(558)

UNITS: dollars

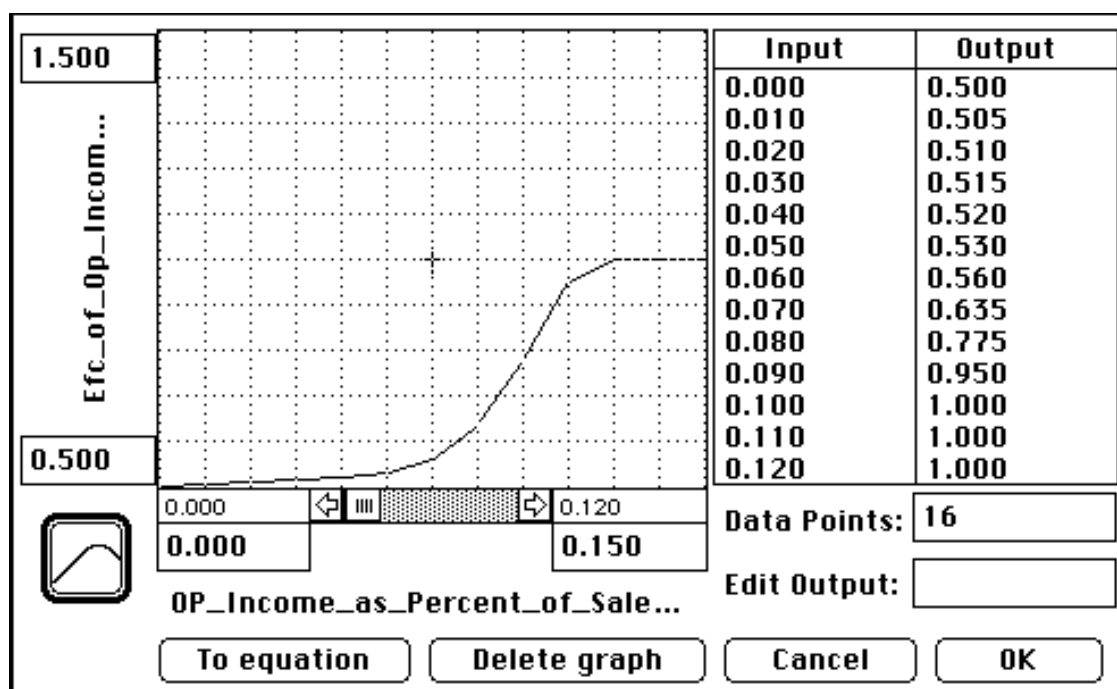

549: Efc_of_Op_Income_vs_Sales_on_Valuation = GRAPH(OP_Income_as_Percent_of_Sales*(1-Operating_Income_Switch)+Operating_Income_Switch)(0.00, 0.5), (0.01, 0.505), (0.02, 0.51), (0.03, 0.515), (0.04, 0.52), (0.05, 0.53), (0.06, 0.56), (0.07, 0.635), (0.08, 0.775), (0.09, 0.95), (0.1, 1.00), (0.11, 1.00), (0.12, 1.00)

DATA: Actual_Operating_as_Percent_of_Sales_by_Y*

DEFN: Effect of Operating Income versus Sales on Analog's Market Value

USES: OP_Income_as_Percent_of_Sales(540) Operating_Income_Switch(659)

AFFX: Analyst_Valuation_of_Analog(527)

UNITS: dimensionless

The actual share price is then calculated as the current valuation divided by the number of shares outstanding. The standard ratios are also calculated: earnings per share, equity per share, return on capital, return on equity, and the price/earnings ratio. The ratio of the market value to current annualized cash flow is also determined.

546: $\text{Stock_Price} = \text{Analyst_Valuation_of_Analog} / \text{Shares_Outstanding}$

DEFN: Stock Price

USES: Analyst_Valuation_of_Analog(527) Shares_Outstanding(551)

AFFX: PE_Ratio(541)

UNITS: dollars/share

530: $\text{Earnings_per_Share} = \text{Net_Income} / \text{Shares_Outstanding}$

DEFN: Earnings per Share

USES: Net_Income(433) Shares_Outstanding(551)

AFFX: PE_Ratio(541)

UNITS: dollars/share

532: $\text{Equity_per_Share} = \text{Equity} / \text{Shares_Outstanding}$

DEFN: Equity per Share

USES: Equity(531) Shares_Outstanding(551)

UNITS: dollars/share

543: $\text{Return_on_Capital} = \text{Net_Income} / \text{Total_Employed_Capital}$

DEFN: Return on Capital

USES: Net_Income(433) Total_Employed_Capital(490)

UNITS: dimensionless

544: $\text{Return_on_Equity} = \text{Net_Income} / \text{Equity}$

DEFN: Return on Equity

USES: Equity(531) Net_Income(433)

UNITS: dimensionless

541: $\text{PE_Ratio} = \text{Stock_Price} / \text{Earnings_per_Share}$

DEFN: Price/Earnings Ratio

USES: Earnings_per_Share(530) Stock_Price(546)

UNITS: dimensionless

539: $\text{Market_Value_to_Cash_Flow} = \text{Analyst_Valuation_of_Analog} / (\text{Cash_Flow_Accumulator} + 1e-9)$

DEFN: Market Value to Cash Flow

USES: Analyst_Valuation_of_Analog(527) Cash_Flow_Accumulator(611)

UNITS: dimensionless

11. Financial Stress

The level of financial stress is a critical determinant of the model's behavior. Financial stress is a construct, defined over the zero to one interval, that measures management's willingness to take actions that improve current profitability when faced with short-run/long-run tradeoffs. A value of zero indicates no financial stress, that is management makes decisions based solely on long run performance, a value of one indicates extreme financial stress, management is willing to take almost any action that will boost short run profits. The level of financial stress affects numerous management decisions including, willingness to lay-off workers, and capital and labor acquisition.

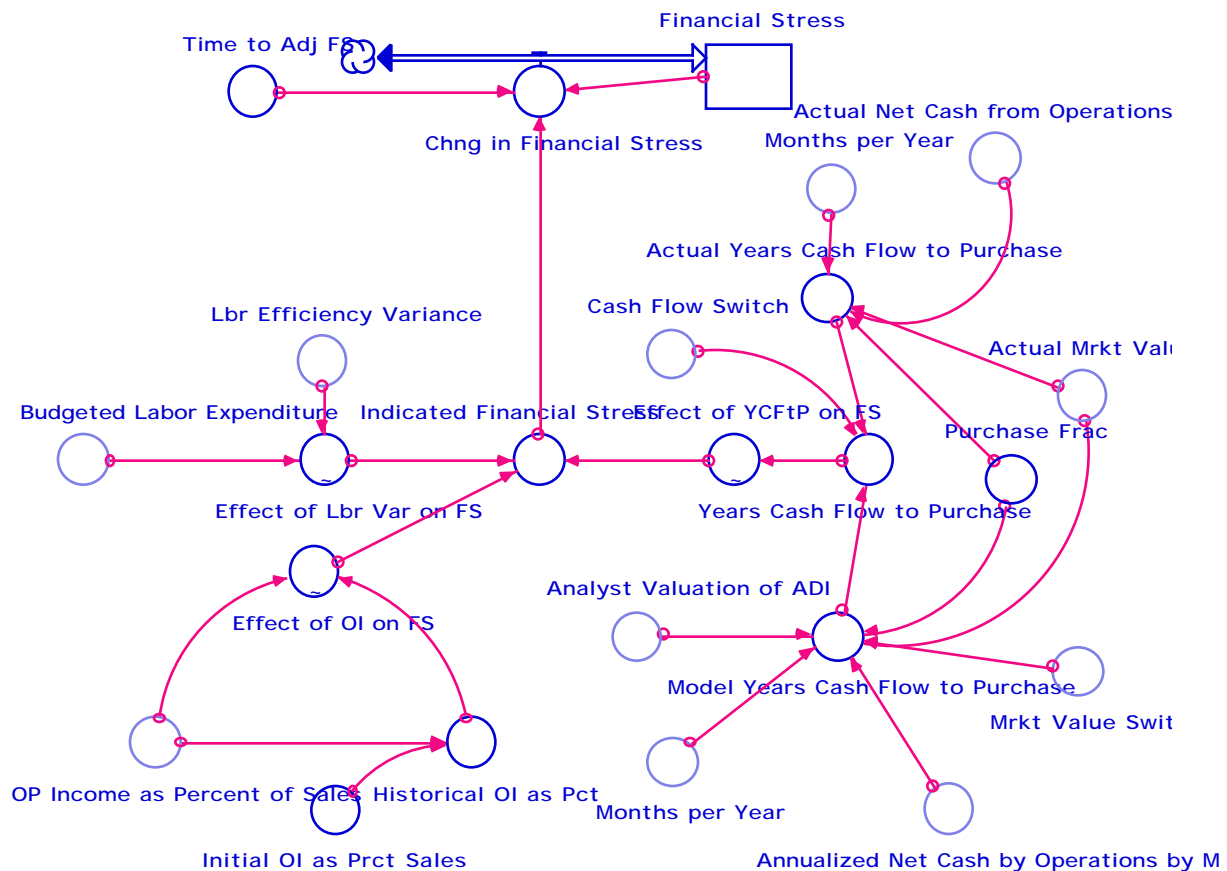

The current level of financial stress is an exponentially weighted average of the indicated financial stress. The time constant for this process is assumed to be three months. The delay represents the time required for the various components of financial stress to be measured and reported. The formulation assumes that this is done on a quarterly basis.

552: $Financial_Stress = Financial_Stress * (t-dt) + (Chng_in_Financial_Stress) * dt$
 INIT: 0

DEFN: Financial Stress

USES: Chng_in_Financial_Stress(553)

AFFX: Efc_of_BP_on_Time_Thru_Fab(59) Orders_for_Capacity(190) Hires(201)

Effect_of_Financial_Stress_on_Layoffs(209) Perceived_Job_Security(284)

Eff_of_Financial_Stress_on_Mgt_Comm(293) Chng_in_Financial_Stress(553)

UNITS: dimensionless

$$553: \text{Chng_in_Financial_Stress} = (\text{Indicated_Financial_Stress} - \text{Financial_Stress}) / \text{Time_to_Adj_FS}$$

DEFN: Change in Financial Stress

USES: Financial_Stress(552) Indicated_Financial_Stress(556) Time_to_Adj_FS(560)

AFFX: Financial_Stress(552)

UNITS: 1/months

$$560: \text{Time_to_Adj_FS} = 3$$

DEFN: Average Time Required to Adjust Financial Stress

AFFX: Chng_in_Financial_Stress(553)

UNITS: months

The indicated level of financial stress is a function of three measurements: operating income measured as a percent of sales, the number of years cash flow required to purchase the company, and the labor efficiency variance measured as a percent of total labor expenditure. Each of these measurements is weighted by a non-linear function. The indicated financial stress is equal to the sum of the three elements.

556: Indicated_Financial_Stress =

$$\text{MIN}(1, ((\text{Effect_of_OI_on_FS}) + \text{Effect_of_YCFtP_on_FS} + \text{Effect_of_Lbr_Var_on_FS}))$$

DEFN: Indicated Financial Stress

USES: Effect_of_Lbr_Var_on_FS(562) Effect_of_OI_on_FS(563) Effect_of_YCFtP_on_FS(564)

AFFX: Chng_in_Financial_Stress(553)

UNITS: dimensionless

The labor efficiency variance is equal to the difference between the actual and budgeted number of wafer starts multiplied by the allocated labor cost per wafer. This number will be large and negative when many fewer wafers are started than were budgeted. This can be interpreted as either a sign of excess capacity or declining sales. In either case it can be a sign of oncoming financial stress and may lead management to downsize. This phenomenon is documented in Kaplan [1991a].

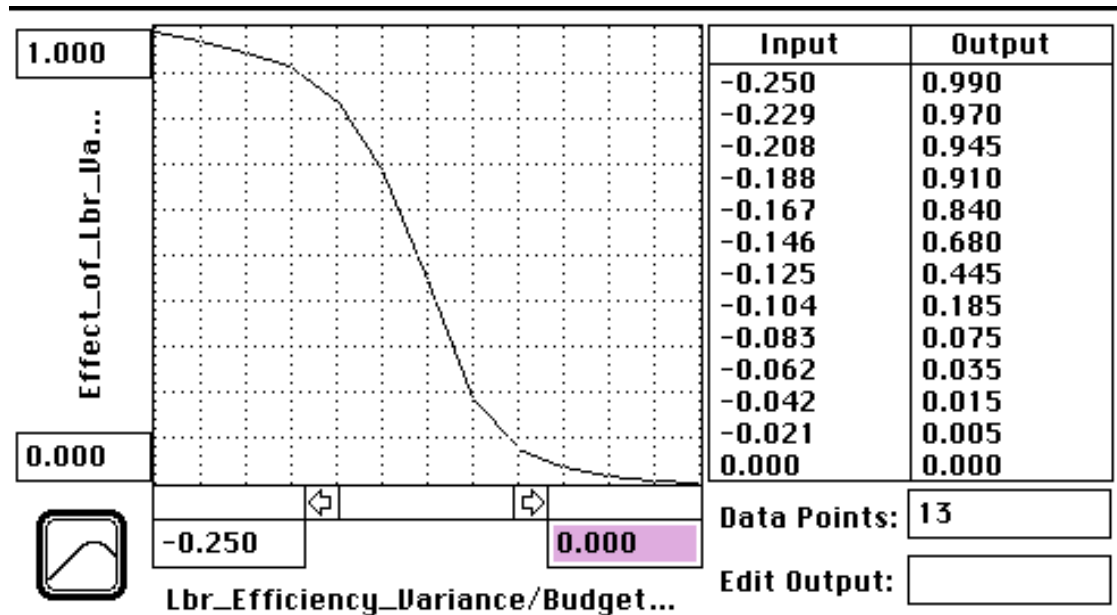

562: Effect_of_Lbr_Var_on_FS = GRAPH(Lbr_Efficiency_Variance/Budgeted_Labor_Expenditure)
 DATA: (-0.25, 0.99), (-0.229, 0.97), (-0.208, 0.945), (-0.187, 0.91), (-0.167, 0.84), (-0.146, 0.68), (-0.125, 0.445), (-0.104, 0.185), (-0.0833, 0.075), (-0.0625, 0.035), (-0.0417, 0.015), (-0.0208, 0.005), (3.59e-17, 0.00)

DEFN: The Effect of the Labor Efficiency Variance on Financial Stress
 USES: Budgeted_Labor_Expenditure(373) Lbr_Efficiency_Variance(376)
 AFFX: Indicated_Financial_Stress(556)
 UNITS: dimensionless

Dramatic decreases in operating income as a percent of sales can also induce financial stress. The reference operating income calculated as a percent of sales revenue is assumed to be an exponentially weighted average of actual operating income as a percent of sales. The initial value of the average return is assumed to be 10% based upon historical data. The difference between the current and expected operating income, calculated as a percent of sales, is weighted by a non-linear graphical function to determine its effect on financial stress. The function's domain is defined from -20% to 0. The function is weakly decreasing with second derivative that is initially positive but becomes negative at approximately the mid-point. The flat section at the right hand side of the horizontal axis represent the assumption that small reductions in income do not cause much financial stress, but as the gap grows larger, the induced financial stress grows exponentially as the possibility that the drop was caused by random fluctuations becomes more remote. The curve begins to level off as financial stress approaches its maximum

555: Historical_OI_as_Pct = SMTH1(OP_Income_as_Percent_of_Sales,24,Initial_OI_as_Prct_Sales)

DEFN: Historical Operating Income as a Percent of Sales
 USES: Initial_OI_as_Prct_Sales(557) OP_Income_as_Percent_of_Sales(540)
 AFFX: Effect_of_OI_on_FS(563)
 UNITS: dimensionless

557: Initial_OI_as_Prct_Sales = .1

DEFN: Initial Condition for Operating Income as a Percent of Sales

AFFX: Historical_OI_as_Pct(555)

UNITS: dimensionless

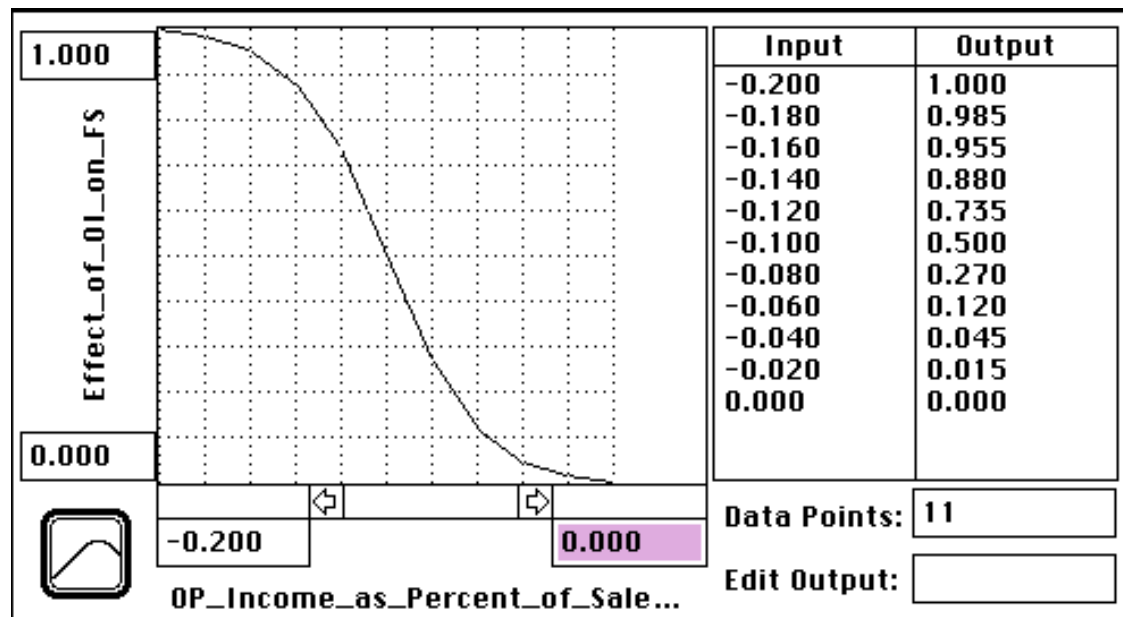

563: Effect_of_OI_on_FS = GRAPH(OP_Income_as_Percent_of_Sales-Historical_OI_as_Pct)
 DATA: (-0.2, 1.00), (-0.18, 0.985), (-0.16, 0.955), (-0.14, 0.88), (-0.12, 0.735), (-0.1, 0.5), (-0.08, 0.27), (-0.06, 0.12), (-0.04, 0.045), (-0.02, 0.015), (-2.01e-17, 0.00)

DEFN: Effect of Operating Income as a Percent of Sales on Financial Stress

USES: Historical_OI_as_Pct(555) OP_Income_as_Percent_of_Sales(540)

AFFX: Indicated_Financial_Stress(556)

UNITS: dimensionless

The final determinant of the indicated level of financial stress is the number of years of current annual cash flow required to purchase Analog in a hostile take-over. This multiple is calculated as the current market valuation of Analog multiplied by the fraction of ownership required to execute a hostile take-over divided by the current annualized net cash generated by operations. The required purchase fraction is assumed to be 40%. This multiple is then weighted by a non-linear function to determine its effect on the indicated level of financial stress. The function is defined over the interval one to seven years and its output ranges from zero to one. It is weakly decreasing with second derivative that is initially positive and becomes negative approximately at the mid-point. The function is based upon the assumption that at multiples of five years or more the company is not a particularly attractive take-over target. However, as the multiple falls below five, the probability of a take-over increases rapidly, and as a result, financial stress increases quickly. At a

multiple of three the contribution to financial stress is .95 indicating that a take-over is very likely. This assumption is based upon historical experience. During the summer of 1990 Analog's multiple fell to three and management *believed* that the take-over threat was very significant [Schneiderman 1992b].

561: $\text{Years_Cash_Flow_to_Purchase} = \text{Model_Years_Cash_Flow_to_Purchase} * (1 - \text{Cash_Flow_Switch}) + \text{Actual_Years_Cash_Flow_to_Purchase} * \text{Cash_Flow_Switch}$

DEFN: Years Cash Flow to Purchase on Financial Stress

USES: Actual_Years_Cash_Flow_to_Purchase(554) Cash_Flow_Switch(650)

Model_Years_Cash_Flow_to_Purchase(558)

AFFX: Effect_of_YCFtP_on_FS(564)

UNITS: dimensionless

554: $\text{Actual_Years_Cash_Flow_to_Purchase} = (\text{Actual_Mrkt_Value} * \text{Purchase_Frac}) / (\text{Actual_Net_Cash_from_Operations_by_M} * \text{Months_per_Year})$

DEFN: Actual Years Cash Flow to Purchase

USES: Actual_Mrkt_Value(526) Actual_Net_Cash_from_Operations_by_M(640) Months_per_Year(657) Purchase_Frac(559)

AFFX: Years_Cash_Flow_to_Purchase(561)

UNITS: dimensionless

558: $\text{Model_Years_Cash_Flow_to_Purchase} = (\text{Analyst_Valuation_of_Analog} * (1 - \text{Mrkt_Value_Switch}) + \text{Actual_Mrkt_Value} * \text{Mrkt_Value_Switch}) * \text{Purchase_Frac} / (\text{Annualized_Net_Cash_by_Operations_by_M} * \text{Months_per_Year})$

DEFN:

USES: Actual_Mrkt_Value(526) Analyst_Valuation_of_Analog(527)

Annualized_Net_Cash_by_Operations_by_M(499) Months_per_Year(657) Mrkt_Value_Switch(658) Purchase_Frac(559)

AFFX: Years_Cash_Flow_to_Purchase(561)

UNITS: dimensionless

559: $\text{Purchase_Frac} = .4$

DEFN: Fraction of Stock Required to Take-Over Company

AFFX: Actual_Years_Cash_Flow_to_Purchase(554) Model_Years_Cash_Flow_to_Purchase(558)

UNITS: dimensionless

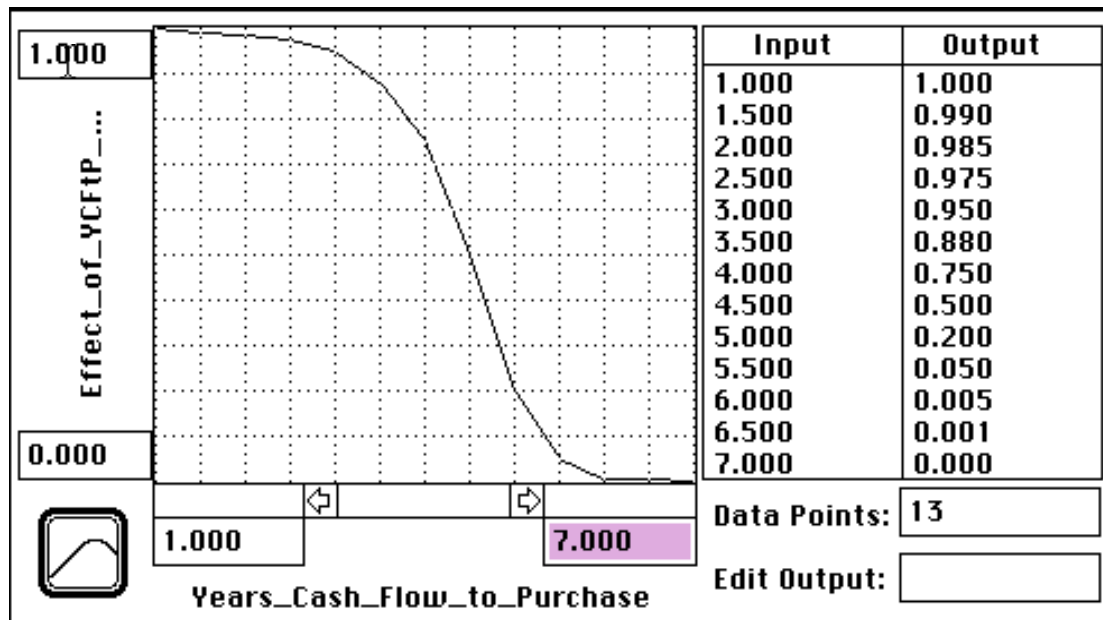

564: Effect_of_YCFtP_on_FS = GRAPH(Years_Cash_Flow_to_Purchase)
 DATA: (1.00, 1.00), (1.50, 0.99), (2.00, 0.985), (2.50, 0.975), (3.00, 0.95), (3.50, 0.88), (4.00, 0.75), (4.50, 0.5), (5.00, 0.2), (5.50, 0.05), (6.00, 0.005), (6.50, 0.001), (7.00, 0.00)

DEFN: Effect of Years Cash Flow to Purchase on Financial Stress
 USES: Years_Cash_Flow_to_Purchase(561)
 AFFX: Indicated_Financial_Stress(556)
 UNITS: dimensionless

12. Competitor

12.0 Overview

Analog is assumed to face a single aggregate competitor. The competitor supplies products that compete directly with Analog's. Market share depends on the customer's assessments of Analog's price, defects, lead time, and delivery reliability compared to that of the competitor. The competitor's quality efforts are endogenously generated, although not modeled with the detail of those for Analog. Rather, the competitor assumes to follow Analog's quality performance or an exogenous target depending on which is better. The exogenous target is generated using the same improvement half-lives faced by Analog but with a latter starting date. This assumption is based upon Analog's early adoption of TQM and its industry leading quality performance. An identical structure is used for each quality index except for pricing.

12.1 Defects

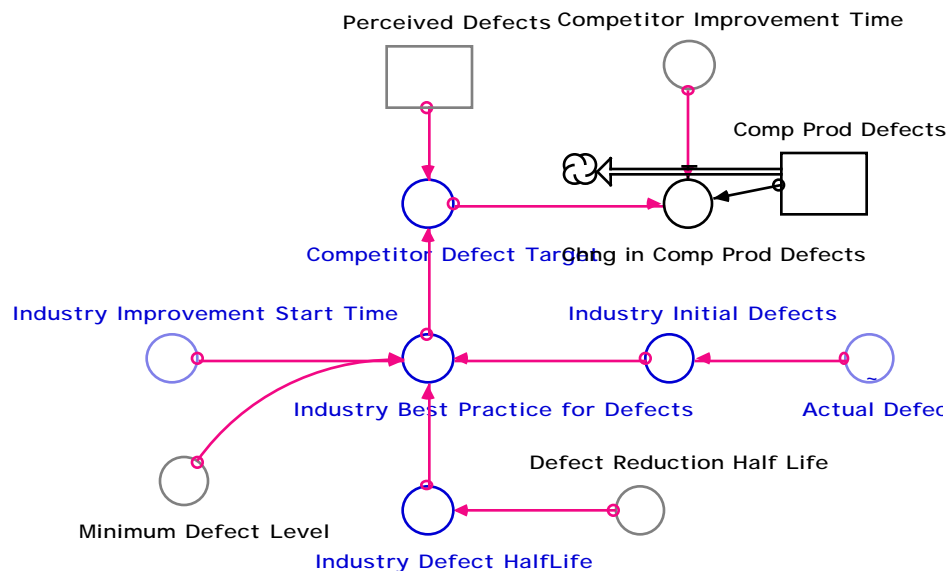

The current level of defects in the competitor's products is an exponentially weighted average of the competitor's current target defect level. The time constant is assumed to be six months. The delay represents the time required for the competitor to identify the current best practice and adopt that practice in its own operations.

571: $Comp_Prod_Defects = Comp_Prod_Defects * (t-dt) + (- Chng_in_Comp_Prod_Defects) * dt$
 INIT: Perceived_Defects

DEFN: Outgoing Defects in Competitor Products

USES: Chng_in_Comp_Prod_Defects(572) Perceived_Defects(85)

AFFX: Efc_of_Defects_on_Comp_Attract(105) Chng_in_Comp_Prod_Defects(572)

UNITS: outgoing defects/million

572: $\text{Chng_in_Comp_Prod_Defects} = (\text{Comp_Prod_Defects} - \text{Competitor_Defect_Target}) / \text{Competitor_Improvement_Time}$

DEFN: Change in Outgoing Defects in Competitor Products
 USES: Comp_Prod_Defects(571) Competitor_Defect_Target(580)
 Competitor_Improvement_Time(692)
 AFFX: Comp_Prod_Defects(571)
 UNITS: outgoing defects/million/month

692: $\text{Competitor_Improvement_Time} = 6$

DEFN: Average Time Required for the Competitor to Imitate Quality Improvements
 AFFX: Chng_in_Comp_Lead_Time(566) Chng_In_Comp_OTD(568)
 Chng_in_Comp_Prod_Defects(572)
 UNITS: months

The competitor's target defect level is assumed to be the minimum of Analog's perceived defect level and the current industry best practice. The industry's best practice for defects is assumed to follow the simple half-life model with a half-life identical to that of Analog. The start time for this process is assumed to be the thirty-sixth month of the simulation, twelve months after Analog begins TQM. The initial defect level is also assumed to equal that of Analog.

580: $\text{Competitor_Defect_Target} = \text{Min}(\text{Perceived_Defects}, \text{Industry_Best_Practice_for_Defects})$

DEFN: Competitor's Target for Outgoing Defects
 USES: Industry_Best_Practice_for_Defects(584) Perceived_Defects(85)
 AFFX: Chng_in_Comp_Prod_Defects(572)
 UNITS: outgoing defects/million

584: $\text{Industry_Best_Practice_for_Defects} = \text{Minimum_Defect_Level} + (\text{Industry_Initial_Defects} - \text{Minimum_Defect_Level}) * \text{EXP}(-\text{MAX}(0, (\text{TIME} - \text{Industry_Improvement_Start_Time})) / (\text{Industry_Defect_HalfLife} / \text{LOGN}(2)))$

DEFN: Industry Best Practice for Outgoing Defects
 USES: Industry_Defect_HalfLife(587) Industry_Improvement_Start_Time(588)
 Industry_Initial_Defects(590) Minimum_Defect_Level(246)
 AFFX: Competitor_Defect_Target(580)
 UNITS: outgoing defects/million

587: $\text{Industry_Defect_HalfLife} = \text{Defect_Reduction_Half_Life}$

DEFN: Industry Half-Life for Defects Reduction
 USES: Defect_Reduction_Half_Life(233)
 AFFX: Industry_Best_Practice_for_Defects(584)
 UNITS: months

590: $\text{Industry_Initial_Defects} = \text{INIT}(\text{Actual_Defects})$

DEFN: Initial Condition for Industry Defects
 USES: Actual_Defects(672)
 AFFX: Industry_Best_Practice_for_Defects(584)
 UNITS: outgoing defects/million

588: Industry_Improvement_Start_Time = 36

DEFN: Improvement Start Time for the Competitor

AFFX: Decr_in_Cycle_Time(575) Incr_in_Ind_Yield(577) Industry_Best_Practice_for_Defects(584)

Industry_Best_Practice_for_Lead_Time(585) Industry_Best_Practice_OTD(586)

UNITS: months

12.2 Lead Time

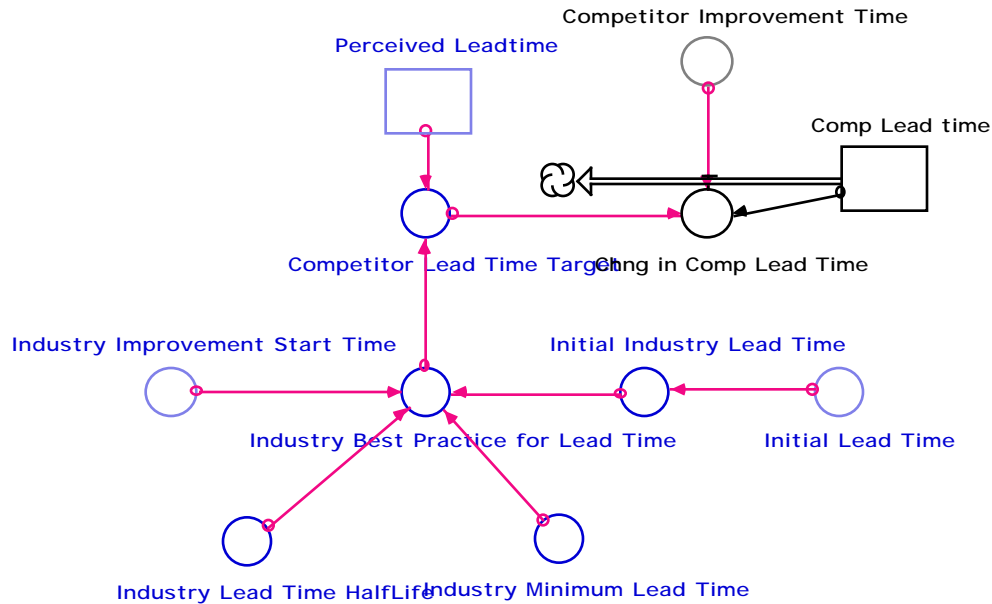

The lead time for acquisition of the competitor's products is an exponentially weighted average of the competitor's current target lead time. The time constant is assumed to be six months. The delay represents the time required for the competitor to identify the current best practice and adopt that practice in its own operations.

565: $Comp_Lead_time = Comp_Lead_time * (t-dt) + (- Chng_in_Comp_Lead_Time) * dt$

INIT: Initial_Lead_Time

DEFN: Competitor Lead Time

USES: Chng_in_Comp_Lead_Time(566) Initial_Lead_Time(655)

AFFX: Efc_of_Lead_Time_on_Comp_Attract(106) Chng_in_Comp_Lead_Time(566)

UNITS: months

566: $Chng_in_Comp_Lead_Time = (Comp_Lead_time - Competitor_Lead_Time_Target) / (Competitor_Improvement_Time)$

DEFN: Change in the Competitor's Lead Time
 USES: Comp_Lead_time(565) Competitor_Improvement_Time(692)
 Competitor_Lead_Time_Target(581)
 AFFX: Comp_Lead_time(565)
 UNITS: months/month

The competitor's target lead time is assumed to be the minimum of Analog's perceived lead-time and the current industry best practice. The industry's best practice for lead time is assumed to follow the simple half-life model with a half-life of nine months. The start time for this process is assumed to be the thirty-sixth month of the simulation, twelve months after Analog begins TQM. The initial and minimum lead times are also assumed to equal that of Analog.

581: Competitor_Lead_Time_Target =
 MIN(Perceived_Leadtime,Industry_Best_Practice_for_Lead_Time)

DEFN: Competitor's Target Lead Time
 USES: Industry_Best_Practice_for_Lead_Time(585) Perceived_Leadtime(87)
 AFFX: Chng_in_Comp_Lead_Time(566)
 UNITS: months

585: Industry_Best_Practice_for_Lead_Time =
 Industry_Minimum_Lead_Time+(Initial_Industry_Lead_Time-Industry_Minimum_Lead_Time)*EXP(-
 MAX(0,(TIME-Industry_Improvement_Start_Time))/(Industry_Lead_Time_HalfLife/LOGN(2))))

DEFN: Industry Best Practice for Lead Time
 USES: Industry_Improvement_Start_Time(588) Industry_Lead_Time_HalfLife(591)
 Industry_Minimum_Lead_Time(592) Initial_Industry_Lead_Time(594)
 AFFX: Competitor_Lead_Time_Target(581)
 UNITS: months

591: Industry_Lead_Time_HalfLife = 9

DEFN: Improvement Half-Life for the Competitor's Lead Time
 AFFX: Industry_Best_Practice_for_Lead_Time(585)
 UNITS: months

592: Industry_Minimum_Lead_Time = 2

DEFN: Minimum Lead Time for the Competitor
 AFFX: Industry_Best_Practice_for_Lead_Time(585)
 UNITS: months

594: Initial_Industry_Lead_Time = Initial_Lead_Time

DEFN: Initial Condition for the Competitor's Lead Time
 USES: Initial_Lead_Time(655)
 AFFX: Industry_Best_Practice_for_Lead_Time(585)
 UNITS: months

12.3 On-Time Delivery

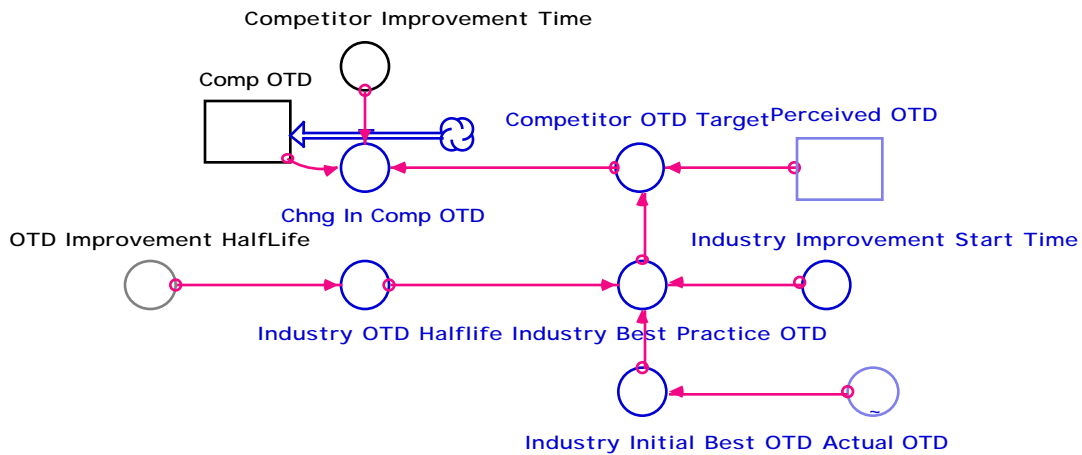

The competitor's on-time delivery percentage is an exponentially weighted average of the competitor's current target on-time delivery. The time constant is assumed to be six months. The delay represents the time required for the competitor to identify the current best practice and adopt that practice in its own operations.

567: $Comp_OTD = Comp_OTD * (t-dt) + (Chng_In_Comp_OTD) * dt$
 INIT: Actual_OTD

DEFN: Competitor's On-Time Delivery Percentage
 USES: Actual_OTD(678) Chng_In_Comp_OTD(568)
 AFFX: Efc_of_OTD_on_Comp_Attract(108) Chng_In_Comp_OTD(568)
 UNITS: dimensionless

568: $Chng_In_Comp_OTD = MAX(0, (Competitor_OTD_Target - Comp_OTD) / Competitor_Improvement_Time)$

DEFN: Change in the Competitor's On-Time Delivery Percentage
 USES: Comp_OTD(567) Competitor_Improvement_Time(692) Competitor_OTD_Target(582)
 AFFX: Comp_OTD(567)
 UNITS: 1/months

The competitor's target on-time delivery is assumed to be the maximum of Analog's perceived lead-time and the current industry best practice. The industry's best practice for on time delivery is assumed to follow the simple half-life model with a half-life identical to that of Analog. The start time for this process is assumed to be the thirty-sixth month of the simulation, twelve months after Analog begins TQM. The initial and maximum levels are also assumed to equal those of Analog.

582: $Competitor_OTD_Target = MAX(Perceived_OTD, Industry_Best_Practice_OTD)$

DEFN: Competitor's Target for On-Time Delivery
 USES: Industry_Best_Practice_OTD(586) Perceived_OTD(89)
 AFFX: Chng_In_Comp_OTD(568)
 UNITS: dimensionless

586: $Industry_Best_Practice_OTD = (1 - (1 - Industry_Initial_Best_OTD) * EXP(-MAX(0, (TIME - Industry_Improvement_Start_Time)) / (Industry_OTD_Halflife / LOGN(2))))$

DEFN: Industry Best Practice for On-Time Delivery
 USES: Industry_Improvement_Start_Time(588) Industry_Initial_Best_OTD(589)
 Industry_OTD_HalfLife(593)
 AFFX: Competitor_OTD_Target(582)
 UNITS: dimensionless

589: $Industry_Initial_Best_OTD = INIT(Actual_OTD)$

DEFN: Intital Condition for Industry Performance on On-Time Delivery
 USES: Actual_OTD(678)
 AFFX: Potential_OTD_Erosion(256) Industry_Best_Practice_OTD(586)
 UNITS: dimensionless

593: $Industry_OTD_HalfLife = OTD_Improvement_HalfLife$

DEFN: Improvement Half-Life for Industry On-Time Delivery
 USES: OTD_Improvement_HalfLife(249)
 AFFX: Industry_Best_Practice_OTD(586)
 UNITS: dimensionless

12.4 Cycle Time

Although cycle time does not directly affect market share it plays an important role in determining the competitor's price. The formulation used here is similar to that used for Analog.

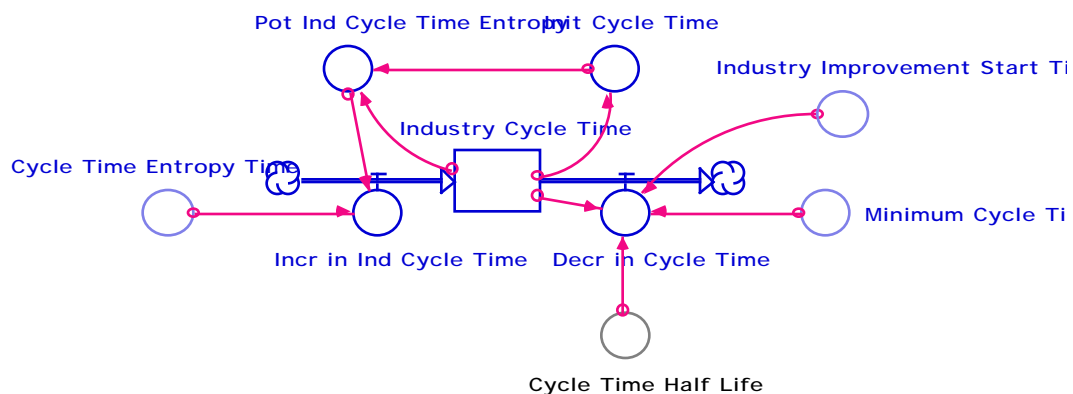

The competitor's cycle time is reduced by improvement and increased by erosion. Cycle time improvement is assumed to follow the simple half life model with an assumed half-life equal to that of Analog. The improvement effort is assumed to begin at month thirty-six. The potential erosion is equal to the difference between the current cycle time and the initial level. The increase in cycle

time due to erosion is equal to the erosion potential divided by the erosion time constant, also assumed to be equal to that of Analog.

573: $Industry_Cycle_Time = Industry_Cycle_Time * (t-dt) + (Incr_in_Ind_Cycle_Time - Decr_in_Cycle_Time) * dt$
 INIT: Actual_Cycle_Time

DEFN: Industry Cycle Time
 USES: Actual_Cycle_Time(671) Decr_in_Cycle_Time(575) Incr_in_Ind_Cycle_Time(574)
 AFFX: Decr_in_Cycle_Time(575) Init_Cycle_Time(595) Pot_Ind_Cycle_Time_Erosion(599)
 Price_Reduction_from_Cycle_Time(607)
 UNITS: months

574: $Incr_in_Ind_Cycle_Time = Pot_Ind_Cycle_Time_Erosion / Cycle_Time_Erosion_Time$

DEFN: Increase in Industry Cycle Time
 USES: Cycle_Time_Erosion_Time(229) Pot_Ind_Cycle_Time_Erosion(599)
 AFFX: Industry_Cycle_Time(573)
 UNITS: months/month

599: $Pot_Ind_Cycle_Time_Erosion = Init_Cycle_Time - Industry_Cycle_Time$

DEFN: Potential Increase in Cycle Time Due to Erosion
 USES: Industry_Cycle_Time(573) Init_Cycle_Time(595)
 AFFX: Incr_in_Ind_Cycle_Time(574)
 UNITS: months

575: $Decr_in_Cycle_Time = IF\ TIME < Industry_Improvement_Start_Time\ then\ 0$
 $else (Industry_Cycle_Time - Minimum_Cycle_Time) / (Cycle_Time_Half_Life / LOGN(2))$

DEFN: Decrease in Industry Cycle Time Due to Improvement
 USES: Cycle_Time_Half_Life(230) Industry_Cycle_Time(573) Industry_Improvement_Start_Time(588)
 Minimum_Cycle_Time(245)
 AFFX: Industry_Cycle_Time(573)
 UNITS: months/month

595: $Init_Cycle_Time = INIT(Industry_Cycle_Time)$

DEFN: Initial Condition for Industry Cycle Time
 USES: Industry_Cycle_Time(573)
 AFFX: Pot_Ind_Cycle_Time_Erosion(599)
 UNITS: months

12.5 Yield

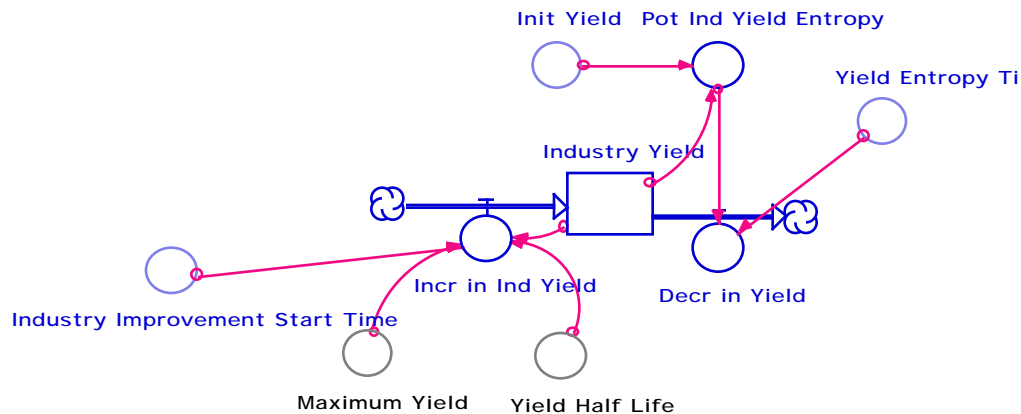

The competitor's yield is increased by improvement and decreased by erosion. Yield improvement is assumed to follow the simple half life model with an assumed half-life equal to that of Analog. The improvement effort is assumed to begin at month thirty-six. The potential erosion is equal to the difference between the current yield and the initial level. The decrease in yield due to erosion is equal to the erosion potential divided by the erosion time constant, also assumed to be equal to that of Analog.

576: $Industry_Yield = Industry_Yield * (t-dt) + (Incr_in_Ind_Yield - Decr_in_Yield) * dt$
 INIT: Actual_Yield

DEFN: Industry Manufacturing Yield
 USES: Actual_Yield(687) Decr_in_Yield(578) Incr_in_Ind_Yield(577)
 AFFX: Incr_in_Ind_Yield(577) Pot_Ind_Yield_Erosion(600) Price_Reduction_from_Yield(608)
 UNITS: dimensionless

577: $Incr_in_Ind_Yield = IF\ TIME < Industry_Improvement_Start_Time\ then\ 0\ else\ (Maximum_Yield - Industry_Yield) / (Yield_Half_Life / LOGN(2))$

DEFN: Increase in Manufacturing Yield Due to Improvement
 USES: Industry_Improvement_Start_Time(588) Industry_Yield(576) Maximum_Yield(243)
 Yield_Half_Life(267)
 AFFX: Industry_Yield(576)
 UNITS 1/months

578: $Decr_in_Yield = Pot_Ind_Yield_Erosion / Yield_Erosion_Time$

DEFN: Decrease in Yield Due to Erosion
 USES: Pot_Ind_Yield_Erosion(600) Yield_Erosion_Time(266)
 AFFX: Industry_Yield(576)
 UNITS: 1/months

600: $Pot_Ind_Yield_Erosion = Industry_Yield - Init_Yield$

DEFN: Potential Decrease in Yield Due to Erosion
 USES: Industry_Yield(576) Init_Yield(239)
 AFFX: Decr_in_Yield(578)
 UNITS: dimensionless

12.6 Pricing

12.6.1 Reduction from Improvement

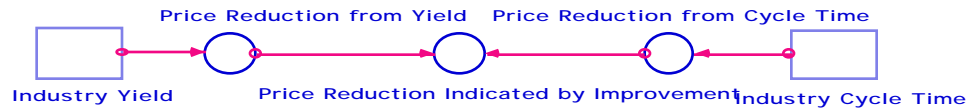

The competitor's price is affected by both Analog's price and the competitor's cost which fall as a result of the competitor's improvement program. The price reduction indicated by the improvement in cycle time is equal to the current cycle time divided by the initial cycle time raised to the three-tenths power. A similar construction is used for the improvement resulting from improvements in yield. The exponent, which is less than one, represents the fact that as the operations are improved new bottlenecks arise that limit the total impact of the improvement program. The total price reduction indicated by the improvement in operations is equal to the price reduction indicated by improvement in cycle time multiplied by the price reduction indicated by improvement in yield.

$$607: \text{Price_Reduction_from_Cycle_Time} = (\text{Industry_Cycle_Time}/\text{INIT}(\text{Industry_Cycle_Time}))^{.3}$$

DEFN: Competitor Price Reduction Due to Cycle Time Improvements
 USES: Industry_Cycle_Time(573)
 AFFX: Price_Reduction_Indicated_by_Improvement(609)
 UNITS: dimensionless

$$608: \text{Price_Reduction_from_Yield} = (\text{Init_Yield}/\text{Industry_Yield})^{.3}$$

DEFN: Competitor Price Reduction Due to Yielded Improvements
 USES: Industry_Yield(576) Init_Yield(239)
 AFFX: Price_Reduction_Indicated_by_Improvement(609)
 UNITS: dimensionless

$$609: \text{Price_Reduction_Indicated_by_Improvement} = \text{Price_Reduction_from_Cycle_Time} * \text{Price_Reduction_from_Yield}$$

DEFN: Total Price Reduction Due to Improvement
 USES: Price_Reduction_from_Cycle_Time(607) Price_Reduction_from_Yield(608)
 AFFX: Price_Indicated_by_Improvement(606)
 UNITS: dimensionless

12.6.2 Competitor Price Index

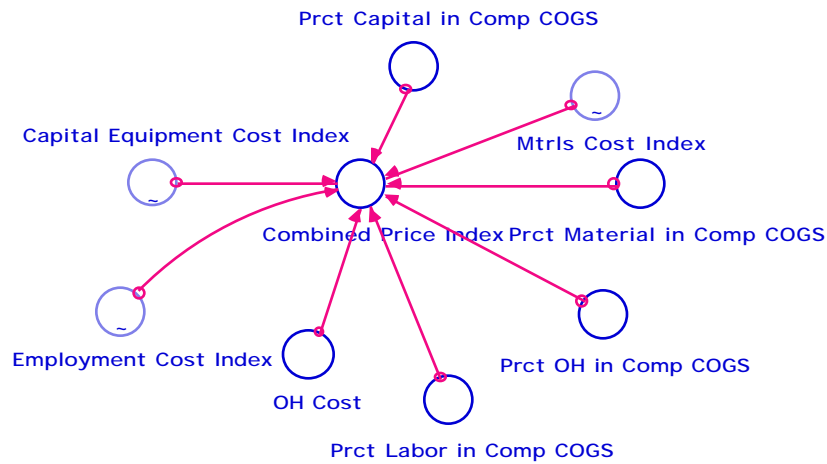

The preceding formulation determines how the real price of the competitor's products falls due to improvement. It is necessary to convert the real price to nominal dollars by applying the appropriated price indices. A combined price index is also calculated for the purpose of determining the competitor's nominal price. The price index is equal to the sum of the various price indices weighted by the fraction of the total cost contributed by each type of expense. The fractions were calculated based upon average values for Analog calculated over the years 1985 to 1990;

579: Combined_Price_Index =
 $(OH_Cost * Prct_OH_in_Comp_COGS) + (Employment_Cost_Index * Prct_Labor_in_Comp_COGS) + (Capital_Equipment_Cost_Index * Prct_Capital_in_Comp_COGS) + (Mtrls_Cost_Index * Prct_Material_in_Comp_COGS)$

DEFN: Combined Price Index

USES: Capital_Equipment_Cost_Index(689) Employment_Cost_Index(690) Mtrls_Cost_Index(338)

OH_Cost(597) Prct_Capital_in_Comp_COGS(601) Prct_Labor_in_Comp_COGS(602)

Prct_Material_in_Comp_COGS(603) Prct_OH_in_Comp_COGS(604)

AFFX: Price_Indicated_by_Improvement(606)

UNITS: dimensionless

597: OH_Cost = 1

DEFN: Overhead Cost of Competitor's Products

AFFX: Combined_Price_Index(579)

UNITS: dimensionless

601: Prct_Capital_in_Comp_COGS = .13

DEFN: Percent of Total Cost Occupied by Capital Expense

AFFX: Combined_Price_Index(579)

UNITS: dimensionless

602: Prct_Labor_in_Comp_COGS = .25

DEFN: Percent of Total Cost Occupied by Labor Expense
 AFFX: Combined_Price_Index(579)
 UNITS: dimensionless

603: Prct_Material_in_Comp_COGS = .22

DEFN: Percent of Total Cost Occupied by Materials Expense
 AFFX: Combined_Price_Index(579)
 UNITS: dimensionless

604: Prct_OH_in_Comp_COGS = .4

DEFN: Percent of Total Cost Occupied by Overhead Expense
 AFFX: Combined_Price_Index(579)
 UNITS: dimensionless

12.6.3 Price Setting

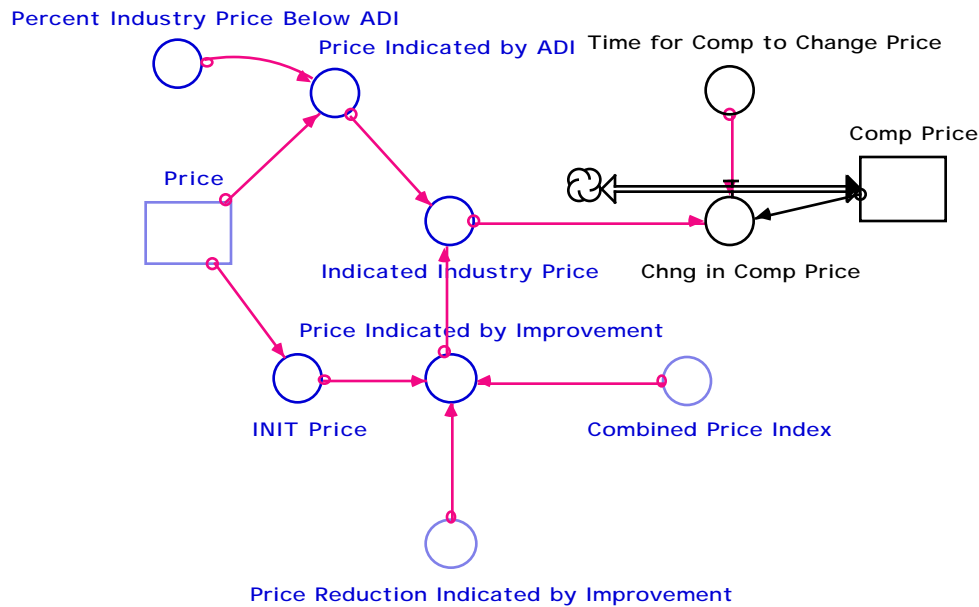

The competitor's price is an exponentially weighted average of the indicated industry price. The time constant is assumed to be three months. The delay represents the time required for the competitor to assess changes in market conditions, determine if any adjustments in price are required based on those changes, and change the price of its products.

569: $Comp_Price = Comp_Price * (t-dt) + (- Chng_in_Comp_Price) * dt$
 INIT: Indicated_Industry_Price

DEFN: Competitor Price
 USES: Chng_in_Comp_Price(570) Indicated_Industry_Price(583)
 AFFX: Efc_of_Price_on_Comp_Attract(94) Ratio_Comp_Price_to_Price(424)
 Chng_in_Comp_Price(570)
 UNITS: dollars/unit

570: $\text{Chng_in_Comp_Price} = (\text{Comp_Price} - \text{Indicated_Industry_Price}) / \text{Time_for_Comp_to_Change_Price}$

DEFN: Change in the Competitor's Price
 USES: Comp_Price(569) Indicated_Industry_Price(583) Time_for_Comp_to_Change_Price(610)
 AFFX: Comp_Price(569)
 UNITS: dollars/unit/month

610: $\text{Time_for_Comp_to_Change_Price} = 3$

DEFN: Average Time Required to Adjust the Competitor's Price
 AFFX: Chng_in_Comp_Price(570)
 UNITS: months

The price indicated by industry is equal to the minimum of the price indicated by the competitor's internal improvement and the price indicated by Analog. The price indicated by Analog is equal to Analog's price marked down by a fixed percentage. The competitor is assumed to undercut Analog's price by ten percent. The price indicated to the competitor by improvement is equal to Analog's initial price multiplied by the combined price index multiplied by the percentage reduction in price indicated by improvement. Thus the competitor aggressively prices at the lesser of its costs or Analog's price so as to maintain market share.

583: $\text{Indicated_Industry_Price} = \text{MIN}(\text{Price_Indicated_by_Analog}, \text{Price_Indicated_by_Improvement})$

DEFN: Price Indicated by the Industry
 USES: Price_Indicated_by_Analog(605) Price_Indicated_by_Improvement(606)
 AFFX: Comp_Price(569) Chng_in_Comp_Price(570)
 UNITS: dollars/unit

605: $\text{Price_Indicated_by_Analog} = (1 - \text{Percent_Industry_Price_Below_Analog}) * \text{Price}$

DEFN: Price Indicated by ADI
 USES: Percent_Industry_Price_Below_Analog(598) Price(413)
 AFFX: Indicated_Industry_Price(583)
 UNITS: dollars/unit

598: $\text{Percent_Industry_Price_Below_Analog} = .1$
 AFFX: Price_Indicated_by_Analog(605)
 UNITS: dimensionless

606: $\text{Price_Indicated_by_Improvement} = \text{Combined_Price_Index} * \text{INIT_Price} * \text{Price_Reduction_Indicated_by_Improvement}$

DEFN: Price Indicated by Improvement
USES: Combined_Price_Index(579) INIT_Price(596) Price_Reduction_Indicated_by_Improvement(609)
AFFX: Indicated_Industry_Price(583)
UNITS: dollars/unit

596: INIT_Price = INIT(Price)

DEFN: Initial Condition for Price
USES: Price(413)
AFFX: Price_Indicated_by_Improvement(606)
UNITS: dollars/unit

13. Accumulators and Actual Data.

For the purpose of comparing the results to actual data many of the series generated by the model are converted from a monthly measurement interval to a quarterly measurement interval. The formulation for this conversion is identical for each instance. The monthly series flow into an accumulator stock. On the required time interval a switch returns a value of one which causes the outflow from the stock to equal the stock itself. For example quarterly revenue as reported by Analog is the accumulation of the continuous revenue stream from the start of the current quarter to the end of the quarter. Thus in the model the continuous revenue stream is accumulated over each quarter. At the end of each quarter the accumulated sum is the total revenue for the quarter. The accumulator is reset to zero and the process repeats for the next quarter. This allows the model output to be compared with the actual data.

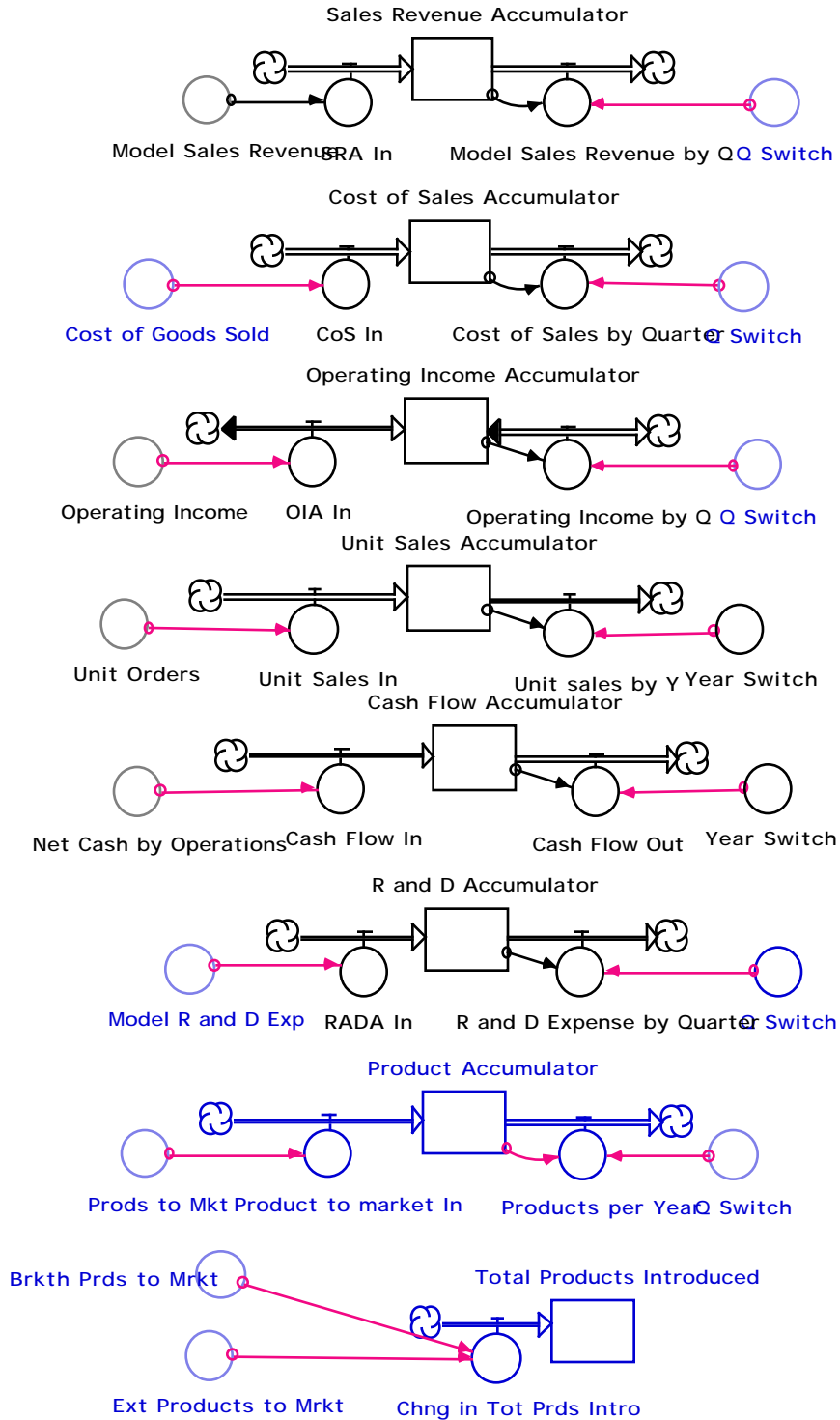

611: $Cash_Flow_Accumulator = Cash_Flow_Accumulator * (t-dt) + (Cash_Flow_In - Cash_Flow_Out) * dt$
 INIT: Actual_Unit_Sales_by_Y

DEFN: Accumulator for Cash Flow

USES: Actual_Unit_Sales_by_Y(683) Cash_Flow_In(612) Cash_Flow_Out(613)

AFFX: Market_Value_to_Cash_Flow(539) Cash_Flow_Out(613)

UNITS: dollars

612: Cash_Flow_In = Net_Cash_by_Operations

DEFN: Increase in Accumulated Cash Flow

USES: Net_Cash_by_Operations(500)

AFFX: Cash_Flow_Accumulator(611)

UNITS: dollars/month

613: Cash_Flow_Out = if Year_Switch_2>0 then Cash_Flow_Accumulator/DT else 0

DEFN: Decrease in Accumulated Cash Flow

USES: Cash_Flow_Accumulator(611) Year_Switch_2(636)

AFFX: Cash_Flow_Accumulator(611)

UNITS: dollars/year

614: Cost_of_Sales_Accumulator = Cost_of_Sales_Accumulator *(t-dt) + (CoS_In_ -
Cost_of_Sales_by_Quarter) * dt

INIT: Actual_Cost_of_Sales_by_Q

DEFN: Accumulator for Cost of Sales

USES: Actual_Cost_of_Sales_by_Q(670) CoS_In_(615) Cost_of_Sales_by_Quarter(616)

AFFX: Cost_of_Sales_by_Quarter(616)

UNITS: dollars

615: CoS_In_ = Cost_of_Goods_Sold

DEFN: Increase in Accumualted Cost of Sales

USES: Cost_of_Goods_Sold(401)

AFFX: Cost_of_Sales_Accumulator(614)

UNITS: dollars/month

616: Cost_of_Sales_by_Quarter = if Q_Switch >0 then Cost_of_Sales_Accumulator/DT else 0

DEFN: Decrease in Accumualted Cost of Sales

USES: Cost_of_Sales_Accumulator(614) Q_Switch(634)

AFFX: Cost_of_Sales_Accumulator(614)

UNITS: dollars/quarter

617: Operating_Income_Accumulator = Operating_Income_Accumulator *(t-dt) + (OIA_In -
Operating_Income_by_Q) * dt

INIT: Actual_Operating_Income_by_Q

DEFN: Accumulator for Operating Income

USES: Actual_Operating_Income_by_Q(677) OIA_In(618) Operating_Income_by_Q(619)

AFFX: Operating_Income_by_Q(619)

UNITS: dollars

618: OIA_In = Operating_Income

DEFN: Increase in Accumulated Operating Income
 USES: Operating_Income(435)
 AFFX: Operating_Income_Accumulator(617)
 UNITS: dollars/month

619: Operating_Income_by_Q = if Q_Switch>0 then Operating_Income_Accumulator/DT else 0

DEFN: Decrease in Accumulated Operating Income
 USES: Operating_Income_Accumulator(617) Q_Switch(634)
 AFFX: Operating_Income_Accumulator(617)
 UNITS: dollars/quarter

620: Product_Accumulator = Product_Accumulator *(t-dt) + (Product_to_market_In -
 Products_per_Quarter) * dt
 INIT: Actual_Prd_Intro_by_Q

DEFN: Accumulator for Product Introductions
 USES: Actual_Prd_Intro_by_Q(679) Product_to_market_In(621) Products_per_Quarter(622)
 AFFX: Products_per_Quarter(622)
 UNITS: products

621: Product_to_market_In = Prods_to_Mkt

DEFN: Increase in Accumulated Product Introductions
 USES: Prods_to_Mkt(46)
 AFFX: Product_Accumulator(620)
 UNITS: products/month

622: Products_per_Quarter = if Q_Switch>0 then Product_Accumulator/dt else 0

DEFN: Decrease in Accumulated Product Introductions
 USES: Product_Accumulator(620) Q_Switch(634)
 AFFX: Product_Accumulator(620)
 UNITS: products/quarter

623: R_and_D_Accumulator = R_and_D_Accumulator *(t-dt) + (RADA_In_ -
 R_and_D_Expense_by_Quarter) * dt
 INIT: Actual_R_and_D_Spending_by_Q

DEFN: Accumulator for Research and Development Spending
 USES: Actual_R_and_D_Spending_by_Q(680) R_and_D_Expense_by_Quarter(625) RADA_In_(624)
 AFFX: R_and_D_Expense_by_Quarter(625)
 UNITS: dollars

624: RADA_In_ = Model_R_and_D_Exp

DEFN: Increase in Accumulated R and D Spending
 USES: Model_R_and_D_Exp(512)
 AFFX: R_and_D_Accumulator(623)
 UNITS: dollars/month

625: R_and_D_Expense_by_Quarter = if Q_Switch >0 then R_and_D_Accumulator/DT else 0

DEFN: Decrease in Accumulated R and D Spending
 USES: Q_Switch(634) R_and_D_Accumulator(623)
 AFFX: R_and_D_Accumulator(623)
 UNITS: dollars/quarter

626: $\text{Sales_Revenue_Accumulator} = \text{Sales_Revenue_Accumulator} * (t-dt) + (\text{SRA_In} - \text{Model_Sales_Revenue_by_Q}) * dt$
 INIT: Actual_Sales_Revenue_by_Q

DEFN: Accumulator for Sales Revenue
 USES: Actual_Sales_Revenue_by_Q(681) Model_Sales_Revenue_by_Q(628) SRA_In(627)
 AFFX: Model_Sales_Revenue_by_Q(628)
 UNITS: dollars

627: $\text{SRA_In} = \text{Model_Sales_Revenue}$

DEFN: Increase in Accumulated Sales Revenue
 USES: Model_Sales_Revenue(432)
 AFFX: Sales_Revenue_Accumulator(626)
 UNITS: dollars/month

628: $\text{Model_Sales_Revenue_by_Q} = \text{if } Q_Switch > 0 \text{ then } (\text{Sales_Revenue_Accumulator}/DT) \text{ else } 0$

DEFN: Decrease in Accumulated Sales Revenue
 USES: Q_Switch(634) Sales_Revenue_Accumulator(626)
 AFFX: Sales_Revenue_Accumulator(626)
 UNITS: dollars/year

629: $\text{Total_Products_Introduced} = \text{Total_Products_Introduced} * (t-dt) + (\text{Chng_in_Tot_Prds_Intro}) * dt$
 INIT: 0

DEFN: Accumulator for Product Introductions
 USES: Chng_in_Tot_Prds_Intro(630)
 UNITS: products

630: $\text{Chng_in_Tot_Prds_Intro} = \text{Brkth_Prds_to_Mrkt} + \text{Ext_Products_to_Mrkt}$

DEFN: Increase in Product Introductions
 USES: Brkth_Prds_to_Mrkt(33) Ext_Products_to_Mrkt(36)
 AFFX: Total_Products_Introduced(629)
 UNITS: products/month

631: $\text{Unit_Sales_Accumulator} = \text{Unit_Sales_Accumulator} * (t-dt) + (\text{Unit_Sales_In} - \text{Unit_sales_by_Y}) * dt$
 INIT: Actual_Unit_Sales_by_Y

DEFN: Accumulator for Unit Sales
 USES: Actual_Unit_Sales_by_Y(683) Unit_sales_by_Y(633) Unit_Sales_In(632)
 AFFX: Unit_sales_by_Y(633)
 UNITS: units

632: $\text{Unit_Sales_In} = \text{Unit_Orders}$

DEFN: Increase in Accumulated Unit Sales
 USES: Unit_Orders(113)
 AFFX: Unit_Sales_Accumulator(631)
 UNITS: units/month

633: $\text{Unit_sales_by_Y} = \text{if } \text{Year_Switch} > 0 \text{ then } \text{Unit_Sales_Accumulator}/DT \text{ else } 0$

DEFN: Decrease in Accumulated Unit Sales
 USES: Unit_Sales_Accumulator(631) Year_Switch(635)
 AFFX: Unit_Sales_Accumulator(631)
 UNITS: units/year

634: Q_Switch = pulse(1,0,3)

DEFN: Quarter Switch

AFFX: Cost_of_Sales_by_Quarter(616) Operating_Income_by_Q(619) Products_per_Quarter(622)
R_and_D_Expense_by_Quarter(625) Model_Sales_Revenue_by_Q(628)

635: Year_Switch = pulse (1,0,12)

DEFN: Year Switch

AFFX: Unit_sales_by_Y(633)

For graphical comparison purposes actual data, measured on an annual or quarterly basis, is converted to monthly data by dividing by the number of months in either a year or a quarter.

637: Actual_Cost_of_Sales_by_M = Actual_Cost_of_Sales_by_Q/Months_per_Quarter

DEFN: Actual Cost of Sales Per Month

USES: Actual_Cost_of_Sales_by_Q(670) Months_per_Quarter(656)

AFFX: Gross_Margin(431) Actual_Effective_Margin(638) Actual_Unit_Cost(648)

UNITS: dollars/quarter

638: Actual_Effective_Margin = (Actual_Sales_Rev_by_M -
Actual_Cost_of_Sales_by_M)/Actual_Sales_Rev_by_M

DEFN: Actual Operating Profit Margin

USES: Actual_Cost_of_Sales_by_M(637) Actual_Sales_Rev_by_M(646)

UNITS: dimensionless

639: Actual_Market_Value_to_Cash_Flow =
Actual_Mrkt_Value/(Actual_Net_Cash_by_Operations_by_Y+1e-9)

DEFN: Actual Market Value to Net Cash Flow

USES: Actual_Mrkt_Value(526) Actual_Net_Cash_by_Operations_by_Y(674)

UNITS: dimensionless

640: Actual_Net_Cash_from_Operations_by_M =
Actual_Net_Cash_by_Operations_by_Y/Months_per_Year

DEFN: Actual Net Cash Generated by Operations per Month

USES: Actual_Net_Cash_by_Operations_by_Y(674) Months_per_Year(657)

AFFX: Actual_Years_Cash_Flow_to_Purchase(554)

UNITS: dollars/month

641: Actual_Net_Income_by_M = Actual_Net_Income_by_Q/Months_per_Quarter

DEFN: Actual Net Income Per Month

USES: Actual_Net_Income_by_Q(675) Months_per_Quarter(656)

AFFX: Actual_Return_on_Sales(644)

UNITS: dollars/month

642: Actual_Operating_Income_by_M = Actual_Operating_Income_by_Q/Months_per_Quarter

DEFN: Actual Operating Income per Month
 USES: Actual_Operating_Income_by_Q(677) Months_per_Quarter(656)
 AFFX: Expected_Annual_Operating_Income(521) Indicated_Annual_Operating_Income(536)
 UNITS: dollars/month

643: $Actual_Product_Intro_by_M = Actual_Prd_Intro_by_Q / Months_per_Quarter$

DEFN: Actual Product Introductions by Month
 USES: Actual_Prd_Intro_by_Q(679) Months_per_Quarter(656)
 AFFX: New_Line_Extension_Mrkt(66) New_Prct_Intros(73)
 UNITS: dollars/month

644: $Actual_Return_on_Sales = Actual_Net_Income_by_M / Actual_Sales_Rev_by_M$

DEFN: Actual Return on Sales
 USES: Actual_Net_Income_by_M(641) Actual_Sales_Rev_by_M(646)
 AFFX: Exp_Return_on_Sales(535)
 UNITS: dimensionless

645: $Actual_R_and_D_Spending_by_M = Actual_R_and_D_Spending_by_Q / Months_per_Quarter$

DEFN: Actual Research and Development Spending by Month
 USES: Actual_R_and_D_Spending_by_Q(680) Months_per_Quarter(656)
 AFFX: Expected_Annual_R_and_D_Budgt(1) R_and_D_Exp(13) Hist_R&D_Fraction(654)
 UNITS: dollars/month

646: $Actual_Sales_Rev_by_M = Actual_Sales_Revenue_by_Q / Months_per_Quarter$

DEFN: Actual Sales Revenue by Month
 USES: Actual_Sales_Revenue_by_Q(681) Months_per_Quarter(656)
 AFFX: Sales_Revenue(436) Actual_Effective_Margin(638) Actual_Return_on_Sales(644)
 Hist_R&D_Fraction(654)
 UNITS: dollars/month

647: $Actual_SG_and_A_by_M = Actual_SG_and_A_by_Q / Months_per_Quarter$

DEFN: Actual Sales General and Administrative Expenses by Month
 USES: Actual_SG_and_A_by_Q(682) Months_per_Quarter(656)
 AFFX: SG_and_A_Incurred(342)
 UNITS: dollars/month

648: $Actual_Unit_Cost = Actual_Cost_of_Sales_by_M / Actual_Unit_Sales_by_M$

DEFN: Actual Unit Cost
 USES: Actual_Cost_of_Sales_by_M(637) Actual_Unit_Sales_by_M(649)
 AFFX: Perceived_Total_per_Unit_Cost(411)
 UNITS: dollars/unit

649: $Actual_Unit_Sales_by_M = Actual_Unit_Sales_by_Y / Months_per_Year$

DEFN: Actual Unit Sales by Month
 USES: Actual_Unit_Sales_by_Y(683) Months_per_Year(657)
 AFFX: Backlog(114) Orders(115) New_CQLT(118) Perceived_Orders(130)
 Chng_in_Forecast_Orders(131) Actual_Unit_Cost(648)
 UNITS: dollars/month

654: $Hist_R\&D_Fraction = Actual_R_and_D_Spending_by_M / Actual_Sales_Rev_by_M$

DEFN: Actual Research and Development Spending as a Fraction of Sales Revenue
 USES: Actual_R_and_D_Spending_by_M(645) Actual_Sales_Rev_by_M(646)
 UNITS: dimensionless

656: Months_per_Quarter = 3

DEFN: Number of Months in a Quarter
 AFFX: Actual_Cost_of_Sales_by_M(637) Actual_Net_Income_by_M(641)
 Actual_Operating_Income_by_M(642) Actual_Product_Intro_by_M(643)
 Actual_R_and_D_Spending_by_M(645) Actual_Sales_Rev_by_M(646) Actual_SG_and_A_by_M(647)
 UNITS: months/quarter

657: Months_per_Year = 12

DEFM: Number of Months in a Year
 AFFX: Expected_Annual_R_and_D_Budgt(1) Chng_in_Exp_R_and_D(2)
 Expected_Annual_Operating_Income(521) Expected_Annual_Sales_Revenue(523)
 Exp_Annual_Growth_in_Earnings(534) Indicated_Annual_Operating_Income(536)
 Indicated_Annual_Sales_Revenue(537) Actual_Years_Cash_Flow_to_Purchase(554)
 Model_Years_Cash_Flow_to_Purchase(558) Actual_Net_Cash_from_Operations_by_M(640)
 Actual_Unit_Sales_by_M(649)
 UNITS: months/year

For reporting purposes a number of key financial measures are also calculated on a per unit basis. In all cases this is done by dividing the current value of the measure by the current rate of deliveries.

660: Per_Unit_Cogs = Cost_of_Goods_Sold/Deliveries

DEFN: Cost per Unit Sold
 USES: Cost_of_Goods_Sold(401) Deliveries(150)
 UNITS: dollars/unit

661: Per_Unit_Gross_margin = Gross_Margin/Deliveries

DEFN: Gross Margin per Unit Sold
 USES: Deliveries(150) Gross_Margin(431)
 UNITS: dollars/unit

662: Per_Unit_Op_Exp = Operating_Exp/Deliveries

DEFN: Operating Expense per Unit
 USES: Deliveries(150) Operating_Exp(434)
 UNITS: dollars/unit

663: Per_Unit_Op_Income = Operating_Income/Deliveries

DEFN: Operating Income Per Unit
 USES: Deliveries(150) Operating_Income(435)
 UNITS: dollars/unit

Throughout the model there are equations in which model generated data can be replaced by the appropriate historical time series. In each case this is accomplished by changing the value of a

switch. A switch value of zero always indicates that the equation is using data generated by the model, while a value of one indicates that the historical data is being used.

650: Cash_Flow_Switch = 0

DEF: Switch for Actual Cash Flow Data
AFFX: Years_Cash_Flow_to_Purchase(561)

651: Cost_of_Sales_Switch = 0

DEF: Switch for Actual Cost of Sales Data
AFFX: Gross_Margin(431)

652: Cycle_Time_Switch = 0

DEF: Switch for Actual Cycle Time Data
AFFX: Cycle_Time(228)

653: Defect_Switch = 0

DEF: Switch for Actual Defect Data
AFFX: Defects(231)

658: Mrkt_Value_Switch = 0

DEF: Switch for Actual Market ValueData
AFFX: Model_Years_Cash_Flow_to_Purchase(558)

659: Operating_Income_Switch = 0

DEF: Switch for Actual Operating Income Data
AFFX: Indicated_Annual_Operating_Income(536) Efc_of_Op_Income_vs_Sales_on_Valuation(549)

664: Prd_Intro_Switch = 0

DEF: Switch for Actual Product Introduction Data
AFFX: New_Line_Extension_Mrkt(66) New_Prduct_Intros(73)

665: R_and_D_Switch = 0

DEF: Switch for Actual R&D Spending Data
AFFX: R_and_D_Exp(13)

666: Sales_Revenue_Switch = 0

DEF: Switch for Actual Sales Revenue Data
AFFX: Sales_Revenue(436)

667: Unit_Sales_Switch = 0

DEF: Switch for Actual Unit Sales Data
AFFX: Orders(115) New_CQLT(118) Chng_in_Forecast_Orders(131)

668: Yield_Switch = 0

DEF: Switch for Actual Yield Data
AFFX: Yield(265)

The actual data series used in the model are presented below along with there sources

669: Actual_Avg_Share_Price_by_Q = GRAPH(Time)

DATA: (0.00, 15.4), (3.00, 14.3), (6.00, 15.8), (9.00, 15.9), (12.0, 15.7), (15.0, 18.5), (18.0, 21.8), (21.0, 19.7), (24.0, 17.3), (27.0, 16.6), (30.0, 20.6), (33.0, 20.9), (36.0, 18.8), (39.0, 10.8), (42.0, 13.1), (45.0, 14.3), (48.0, 11.7), (51.0, 11.2), (54.0, 11.1), (57.0, 11.0), (60.0, 9.87), (63.0, 8.75), (66.0, 7.71), (69.0, 7.53), (72.0, 6.25), (75.0, 6.64), (78.0, 10.6), (81.0, 10.0), (84.0, 7.97), (87.0, 9.67), (90.0, 10.0), (93.0, 10.0), (96.0, 12.8)

DEFN: Quarterly Average Share Price for Analog Devices

SOURCE: Analog Annual Reports [1985-1991]

AFFX: Actual_Mrkt_Value(526)

670: Actual_Cost_of_Sales_by_Q = GRAPH(Time)

DATA: (0.00, 3.6e+07), (3.00, 3.6e+07), (6.00, 3.7e+07), (9.00, 3.9e+07), (12.0, 3.8e+07), (15.0, 3.7e+07), (18.0, 3.7e+07), (21.0, 3.9e+07), (24.0, 3.9e+07), (27.0, 3.7e+07), (30.0, 4.3e+07), (33.0, 4.5e+07), (36.0, 4.7e+07), (39.0, 4.8e+07), (42.0, 5e+07), (45.0, 5.1e+07), (48.0, 5.3e+07), (51.0, 5.4e+07), (54.0, 5.2e+07), (57.0, 5.4e+07), (60.0, 5.5e+07), (63.0, 5.5e+07), (66.0, 5.7e+07), (69.0, 5.9e+07), (72.0, 7.3e+07), (75.0, 6.7e+07), (78.0, 7.1e+07), (81.0, 6.7e+07), (84.0, 6.8e+07), (87.0, 7.3e+07), (90.0, 7.6e+07), (93.0, 7.6e+07), (96.0, 7.7e+07)

DEFN: Analog's Cost of Goods Sold on a Quarterly Basis

SOURCE: Analog Annual Reports [1985-1991]

AFFX: Cost_of_Sales_Accumulator(614) Actual_Cost_of_Sales_by_M(637)

671: Actual_Cycle_Time = GRAPH(TIME)

DATA: (0.00, 4.00), (3.00, 4.00), (6.00, 4.00), (9.00, 4.00), (12.0, 4.00), (15.0, 4.00), (18.0, 4.00), (21.0, 4.00), (24.0, 4.60), (27.0, 3.60), (30.0, 3.00), (33.0, 2.30), (36.0, 2.15), (39.0, 2.00), (42.0, 2.00), (45.0, 2.20), (48.0, 2.00), (51.0, 1.80), (54.0, 1.65), (57.0, 2.00), (60.0, 2.20), (63.0, 2.30), (66.0, 2.10), (69.0, 2.20), (72.0, 2.30), (75.0, 2.20), (78.0, 2.20), (81.0, 2.20), (84.0, 2.20)

DEFN: Analog Manufacturing Cycle Time Reported on a Quarterly Basis

SOURCE: Internal Data Provide by Analog Devices

AFFX: Expected_Cycle_Time(126) Model_Cycle_Time(213) Cycle_Time(228) Initial_Cycle_Time(236) Industry_Cycle_Time(573)

672: Actual_Defects = GRAPH(TIME)

DATA: (0.00, 1500), (1.00, 1500), (2.00, 1500), (3.00, 1500), (4.00, 1500), (5.00, 1500), (6.00, 1500), (7.00, 1500), (8.00, 1500), (9.00, 1500), (10.0, 1500), (11.0, 1500), (12.0, 1500), (13.0, 1500), (14.0, 1500), (15.0, 1500), (16.0, 1500), (17.0, 1500), (18.0, 1500), (19.0, 1500), (20.0, 1500), (21.0, 1500), (22.0, 1500), (23.0, 1500), (24.0, 1500), (25.0, 1500), (26.0, 1600), (27.0, 800), (28.0, 1000), (29.0, 1100), (30.0, 850), (31.0, 900), (32.0, 600), (33.0, 400), (34.0, 650), (35.0, 600), (36.0, 500), (37.0, 500), (38.0, 500), (39.0, 450), (40.0, 475), (41.0, 550), (42.0, 400), (43.0, 400), (44.0, 400), (45.0, 400), (46.0, 400), (47.0, 450), (48.0, 350), (49.0, 225), (50.0, 225), (51.0, 400), (52.0, 375), (53.0, 300), (54.0, 275), (55.0, 225), (56.0, 325), (57.0, 300), (58.0, 300), (59.0, 225), (60.0, 200), (61.0, 250), (62.0, 275), (63.0, 275), (64.0, 180), (65.0, 150), (66.0, 200), (67.0, 175), (68.0, 150), (69.0, 175), (70.0, 150), (71.0, 150), (72.0, 175), (73.0, 125), (74.0, 150), (75.0, 150), (76.0, 150), (77.0, 150), (78.0, 150), (79.0, 150), (80.0, 150), (81.0, 150), (82.0, 150), (83.0, 150), (84.0, 150)

DEFN: Analog's Outgoing Defects Reported on a Monthly Basis

SOURCE: Internal Data Provide by Analog Devices

AFFX: Model_Defects(216) Defects(231) Intial_Defects(240) Industry_Initial_Defects(590)

674: Actual_Net_Cash_by_Operations_by_Y = GRAPH(TIME)

DATA: (0.00, 3.8e+07), (12.0, 4.1e+07), (24.0, 4.5e+07), (36.0, 4.5e+07), (48.0, 6.6e+07), (60.0, 7.4e+07), (72.0, 8.2e+07), (84.0, 5.1e+07)

DEFN: Analog's Net Cash Flow Generated by Operatons Reported Annually

SOURCE: Analog Annual Reports [1985-1991]

AFFX: Actual_Market_Value_to_Cash_Flow(639) Actual_Net_Cash_from_Operations_by_M(640)

675: Actual_Net_Income_by_Q = GRAPH(TIME)

DATA: (0.00, 1e+07), (3.00, 9.3e+06), (6.00, 8.6e+06), (9.00, 6e+06), (12.0, 5.8e+06), (15.0, 6e+06), (18.0, 6e+06), (21.0, 6.4e+06), (24.0, 5.1e+06), (27.0, 2.8e+06), (30.0, 4.7e+06), (33.0, 5e+06), (36.0, 6.1e+06), (39.0, 6.4e+06), (42.0, 9.5e+06), (45.0, 1.1e+07), (48.0, 1.1e+07), (51.0, 9.5e+06), (54.0, 1e+07), (57.0, 7.7e+06), (60.0, 469000), (63.0, 812000), (66.0, 4.7e+06), (69.0, 5.2e+06), (72.0, -2.4e+07), (75.0, 3.7e+06), (78.0, 6.6e+06), (81.0, 589000), (84.0, -2.6e+06), (87.0, -9.7e+05), (90.0, 3.9e+06), (93.0, 5e+06), (96.0, 7e+06)

DEFN: Analog's Net Income Reported on a Quarterly Basis

SOURCE: Analog Annual Reports [1985-1991]

AFFX: Actual_Net_Income_by_M(641)

676: Actual_Operating_as_Percent_of_Sales_by_Y = GRAPH(TIME)

DATA: (0.00, 0.14), (12.0, 0.12), (24.0, 0.09), (36.0, 0.13), (48.0, 0.1), (60.0, 0.01), (72.0, 0.03)

DEFN: Analog's Actual Operating Income Measured as a Percent of Sales Revenue

SOURCE: Operating Income and Sales Revenue Taken from Analog Annual Reports [1985-1991]

677: Actual_Operating_Income_by_Q = GRAPH(Time)

DATA: (0.00, 1.5e+07), (3.00, 1.5e+07), (6.00, 1.4e+07), (9.00, 8.8e+06), (12.0, 9.4e+06), (15.0, 1.1e+07), (18.0, 1.1e+07), (21.0, 1.1e+07), (24.0, 7.3e+06), (27.0, 5.8e+06), (30.0, 8.6e+06), (33.0, 9.6e+06), (36.0, 1e+07), (39.0, 1e+07), (42.0, 1.4e+07), (45.0, 1.6e+07), (48.0, 1.5e+07), (51.0, 1.3e+07), (54.0, 1.3e+07), (57.0, 1.1e+07), (60.0, 6.6e+06), (63.0, 6.9e+06), (66.0, 7e+06), (69.0, 7.2e+06), (72.0, 3.7e+06), (75.0, 6.6e+06), (78.0, 1.1e+07), (81.0, 2.4e+06), (84.0, 4.7e+06), (87.0, 405000), (90.0, 7.1e+06), (93.0, 8.3e+06), (96.0, 1e+07)

DEFN: Analog's Operating Income Reported on a Quarterly Basis

SOURCE: Analog Annual Reports [1985-1991]

AFFX: Operating_Income_Accumulator(617) Actual_Operating_Income_by_M(642)

678: Actual_OTD = GRAPH(TIME)

DATA: (0.00, 0.72), (3.00, 0.72), (6.00, 0.72), (9.00, 0.72), (12.0, 0.72), (15.0, 0.8), (18.0, 0.772), (21.0, 0.825), (24.0, 0.83), (27.0, 0.85), (30.0, 0.873), (33.0, 0.9), (36.0, 0.92), (39.0, 0.925), (42.0, 0.9), (45.0, 0.925), (48.0, 0.95), (51.0, 0.97), (54.0, 0.97), (57.0, 0.97), (60.0, 0.925), (63.0, 0.95), (66.0, 0.9), (69.0, 0.925), (72.0, 0.9), (75.0, 0.925), (78.0, 0.925), (81.0, 0.95), (84.0, 0.925), (87.0, 0.9), (90.0, 0.9), (93.0, 0.9), (96.0, 0.9)

DEFN: Analog's On-Time Delivery Percentage Reported on a Quarterly Basis

SOURCE: Internal Data Provided by Analog Devices

AFFX: Perceived_OTD(89) Indicated_On_Time_Delivery(210) Comp_OTD(567)

Industry_Initial_Best_OTD(589)

679: Actual_Prd_Intro_by_Q = GRAPH(Time)

DATA: (0.00, 15.0), (3.00, 14.0), (6.00, 17.0), (9.00, 21.0), (12.0, 10.0), (15.0, 8.00), (18.0, 22.0), (21.0, 21.0), (24.0, 12.0), (27.0, 14.0), (30.0, 13.0), (33.0, 30.0), (36.0, 9.00), (39.0, 35.0), (42.0, 9.00), (45.0, 30.0), (48.0, 23.0), (51.0, 19.0), (54.0, 16.0), (57.0, 28.0), (60.0, 13.0), (63.0, 28.0), (66.0, 21.0), (69.0, 30.0), (72.0, 19.0), (75.0, 14.0), (78.0, 13.0), (81.0, 10.0), (84.0, 10.0)

DEFN: Analog's New Product Introductions Reported on a Quarterly Basis

SOURCE: Internal Data Supplied by Analog Devices
 AFFX: Product_Accumulator(620) Actual_Product_Intro_by_M(643)

680: Actual_R_and_D_Spending_by_Q = GRAPH(Time)
 DATA: (0.00, 7.1e+06), (3.00, 9.5e+06), (6.00, 9.5e+06), (9.00, 9.5e+06), (12.0, 9.5e+06), (15.0, 9.6e+06), (18.0, 1e+07), (21.0, 1.3e+07), (24.0, 1.3e+07), (27.0, 1.3e+07), (30.0, 1.5e+07), (33.0, 1.4e+07), (36.0, 1.4e+07), (39.0, 1.4e+07), (42.0, 1.5e+07), (45.0, 1.6e+07), (48.0, 1.6e+07), (51.0, 1.6e+07), (54.0, 1.7e+07), (57.0, 1.7e+07), (60.0, 1.8e+07), (63.0, 1.8e+07), (66.0, 2e+07), (69.0, 2.1e+07), (72.0, 2.2e+07), (75.0, 2.1e+07), (78.0, 2.2e+07), (81.0, 2.3e+07), (84.0, 2.3e+07), (87.0, 2.2e+07), (90.0, 2.1e+07), (93.0, 2.2e+07), (96.0, 2.2e+07)

DEFN: Analog's Research and Development Expense Reported on a Quarterly Basis
 SOURCE: Analog Annual Reports [1985-1991]
 AFFX: R_and_D_Accumulator(623) Actual_R_and_D_Spending_by_M(645)

681: Actual_Sales_Revenue_by_Q = GRAPH(Time)
 DATA: (0.00, 8.5e+07), (3.00, 8.2e+07), (6.00, 8.3e+07), (9.00, 7.9e+07), (12.0, 7.9e+07), (15.0, 7.9e+07), (18.0, 8.3e+07), (21.0, 8.7e+07), (24.0, 8.5e+07), (27.0, 8.1e+07), (30.0, 9.4e+07), (33.0, 9.6e+07), (36.0, 1e+08), (39.0, 1e+08), (42.0, 1.1e+08), (45.0, 1.1e+08), (48.0, 1.2e+08), (51.0, 1.1e+08), (54.0, 1.2e+08), (57.0, 1.1e+08), (60.0, 1.1e+08), (63.0, 1.1e+08), (66.0, 1.2e+08), (69.0, 1.2e+08), (72.0, 1.4e+08), (75.0, 1.3e+08), (78.0, 1.4e+08), (81.0, 1.3e+08), (84.0, 1.3e+08), (87.0, 1.3e+08), (90.0, 1.4e+08), (93.0, 1.4e+08), (96.0, 1.5e+08)

DEFN: Analog's Sales Revenue Reported on a Quarterly Basis
 SOURCE: Analog Annual Reports [1985-1991]
 AFFX: Sales_Revenue_Accumulator(626) Actual_Sales_Rev_by_M(646)

682: Actual_SG_and_A_by_Q = GRAPH(TIME)
 DATA: (0.00, 2.4e+07), (3.10, 2.5e+07), (6.19, 2.4e+07), (9.29, 2.4e+07), (12.4, 2.2e+07), (15.5, 2.4e+07), (18.6, 2.4e+07), (21.7, 2.7e+07), (24.8, 2.5e+07), (27.9, 2.7e+07), (31.0, 2.8e+07), (34.1, 2.8e+07), (37.2, 2.9e+07), (40.3, 3.1e+07), (43.4, 3.1e+07), (46.5, 3.2e+07), (49.5, 3.1e+07), (52.6, 3.2e+07), (55.7, 3.1e+07), (58.8, 3.1e+07), (61.9, 3e+07), (65.0, 3.3e+07), (68.1, 3.4e+07), (71.2, 3.9e+07), (74.3, 3.9e+07), (77.4, 3.9e+07), (80.5, 3.8e+07), (83.6, 3.7e+07), (86.7, 3.6e+07), (89.8, 3.8e+07), (92.9, 3.9e+07), (96.0, 3.9e+07)

DEFN: Analog's Sales General and Administrative Expense Reported on a Quarterly Basis
 SOURCE: Analog Annual Reports [1985-1991]
 AFFX: Actual_SG_and_A_by_M(647)

683: Actual_Unit_Sales_by_Y = GRAPH(TIME)
 DATA: (0.00, 2e+07), (12.0, 2e+07), (24.0, 2.2e+07), (36.0, 2.6e+07), (48.0, 3.3e+07), (60.0, 3.4e+07), (72.0, 4.7e+07), (84.0, 6.3e+07)

DEFN: Analog's Unit Sales Reported on a Annual Basis
 SOURCE: Internal Data Supplied by Analog Devices
 AFFX: Potential_Mrkt(68) Cash_Flow_Accumulator(611) Unit_Sales_Accumulator(631)
 Actual_Unit_Sales_by_M(649)

684: Actual_Value_of_FG_Inventory = GRAPH(Time)
 DATA: (0.00, 1.7e+07), (12.0, 1.5e+07), (24.0, 1.7e+07), (36.0, 2e+07), (48.0, 2.6e+07), (60.0, 2.9e+07), (72.0, 3.8e+07), (84.0, 4e+07)

DEFN: Analog's Value of Finished Goods Inventory Reported on an Annual Basis
 SOURCE: Analog Annual Reports [1985-1991]

685: Actual_Value_of_Mtrl_Inventory = GRAPH(Time)

DATA: (0.00, 2.3e+07), (12.0, 2.3e+07), (24.0, 2.2e+07), (36.0, 2.2e+07), (48.0, 2.7e+07), (60.0, 2.5e+07), (72.0, 2.1e+07), (84.0, 2.5e+07)

DEFN: Analog's Value of Materials Inventory Reported on an Annual Basis

SOURCE: Analog Annual Reports [1985-1991]

AFFX: Mtrl_Invntry(138) Cost_of_Mtrl_Invntry(322)

686: Actual_Value_of_WIP = GRAPH(Time)

DATA: (0.00, 3.4e+07), (12.0, 3.8e+07), (24.0, 4.1e+07), (36.0, 4.2e+07), (48.0, 4.4e+07), (60.0, 4.4e+07), (72.0, 4.9e+07), (84.0, 5.3e+07)

DEFN: Analog's Value of Work in Process Inventory Reported on an Annual Basis

SOURCE: Analog Annual Reports [1985-1991]

687: Actual_Yield = GRAPH(TIME)

DATA: (0.00, 0.2), (1.00, 0.2), (2.00, 0.2), (3.00, 0.2), (4.00, 0.2), (5.00, 0.2), (6.00, 0.2), (7.00, 0.2), (8.00, 0.2), (9.00, 0.2), (10.0, 0.2), (11.0, 0.2), (12.0, 0.2), (13.0, 0.2), (14.0, 0.2), (15.0, 0.2), (16.0, 0.2), (17.0, 0.2), (18.0, 0.2), (19.0, 0.2), (20.0, 0.2), (21.0, 0.2), (22.0, 0.2), (23.0, 0.2), (24.0, 0.2), (25.0, 0.2), (26.0, 0.2), (27.0, 0.2), (28.0, 0.2), (29.0, 0.2), (30.0, 0.2), (31.0, 0.2), (32.0, 0.2), (33.0, 0.2), (34.0, 0.2), (35.0, 0.25), (36.0, 0.3), (37.0, 0.3), (38.0, 0.25), (39.0, 0.225), (40.0, 0.18), (41.0, 0.25), (42.0, 0.2), (43.0, 0.22), (44.0, 0.27), (45.0, 0.28), (46.0, 0.22), (47.0, 0.25), (48.0, 0.23), (49.0, 0.25), (50.0, 0.23), (51.0, 0.35), (52.0, 0.36), (53.0, 0.32), (54.0, 0.3), (55.0, 0.32), (56.0, 0.38), (57.0, 0.39), (58.0, 0.4), (59.0, 0.36), (60.0, 0.37), (61.0, 0.43), (62.0, 0.42), (63.0, 0.43), (64.0, 0.4), (65.0, 0.4), (66.0, 0.42), (67.0, 0.38), (68.0, 0.42), (69.0, 0.44), (70.0, 0.45), (71.0, 0.45), (72.0, 0.46), (73.0, 0.45), (74.0, 0.45), (75.0, 0.45), (76.0, 0.45), (77.0, 0.45), (78.0, 0.45), (79.0, 0.45), (80.0, 0.45), (81.0, 0.45), (82.0, 0.45), (83.0, 0.45), (84.0, 0.45)

DEFN: Analog's Manufacturing Yield Reported on a Monthly Basis

SOURCE: Internal Data Supplied by Analog Devices

AFFX: Expected_Yield(128) Model_Yield(219) Init_Yield(239) Yield(265) M_Cost_Finished_Goods(325) Industry_Yield(576)

688: Annualized_Market_Yield = GRAPH(TIME)

DATA: (0.00, 0.101), (1.00, 0.0965), (2.00, 0.0912), (3.00, 0.0935), (4.00, 0.0927), (5.00, 0.0909), (6.00, 0.0877), (7.00, 0.0853), (8.00, 0.0872), (9.00, 0.0869), (10.0, 0.0847), (11.0, 0.0787), (12.0, 0.0742), (13.0, 0.071), (14.0, 0.0701), (15.0, 0.0651), (16.0, 0.0628), (17.0, 0.0612), (18.0, 0.0597), (19.0, 0.0607), (20.0, 0.0589), (21.0, 0.0608), (22.0, 0.062), (23.0, 0.0601), (24.0, 0.0596), (25.0, 0.0559), (26.0, 0.0528), (27.0, 0.0507), (28.0, 0.0501), (29.0, 0.0525), (30.0, 0.0503), (31.0, 0.0489), (32.0, 0.0448), (33.0, 0.0452), (34.0, 0.0517), (35.0, 0.0633), (36.0, 0.0649), (37.0, 0.0637), (38.0, 0.0631), (39.0, 0.0657), (40.0, 0.0662), (41.0, 0.0708), (42.0, 0.0684), (43.0, 0.0693), (44.0, 0.0726), (45.0, 0.0808), (46.0, 0.0785), (47.0, 0.0829), (48.0, 0.082), (49.0, 0.0765), (50.0, 0.077), (51.0, 0.0814), (52.0, 0.0786), (53.0, 0.0778), (54.0, 0.0769), (55.0, 0.0754), (56.0, 0.0727), (57.0, 0.0728), (58.0, 0.0722), (59.0, 0.0704), (60.0, 0.068), (61.0, 0.0696), (62.0, 0.0704), (63.0, 0.0677), (64.0, 0.0675), (65.0, 0.0631), (66.0, 0.06), (67.0, 0.0601), (68.0, 0.0642), (69.0, 0.0671), (70.0, 0.0696), (71.0, 0.0685), (72.0, 0.0658), (73.0, 0.0669), (74.0, 0.0595), (75.0, 0.0572), (76.0, 0.056), (77.0, 0.0558), (78.0, 0.0557), (79.0, 0.0553), (80.0, 0.0507), (81.0, 0.0503), (82.0, 0.0502), (83.0, 0.0476), (84.0, 0.0458), (85.0, 0.0428), (86.0, 0.042), (87.0, 0.0393), (88.0, 0.0392), (89.0, 0.0389), (90.0, 0.0399), (91.0, 0.039), (92.0, 0.0392), (93.0, 0.0408), (94.0, 0.0383), (95.0, 0.0409), (96.0, 0.0415)

DEFN: Annualized Market Yield

SOURCE: Standard and Poor's 500

AFFX: Discount_Rate(529)

689: Capital_Equipment_Cost_Index = GRAPH(TIME)

DATA: (0.00, 0.83), (1.00, 0.84), (2.00, 0.84), (3.00, 0.84), (4.00, 0.84), (5.00, 0.84), (6.00, 0.84), (7.00, 0.84), (8.00, 0.85), (9.00, 0.84), (10.0, 0.85), (11.0, 0.85), (12.0, 0.85), (13.0, 0.85), (14.0, 0.86), (15.0,

0.86), (16.0, 0.86), (17.0, 0.86), (18.0, 0.86), (19.0, 0.86), (20.0, 0.86), (21.0, 0.86), (22.0, 0.87), (23.0, 0.87), (24.0, 0.87), (25.0, 0.87), (26.0, 0.87), (27.0, 0.87), (28.0, 0.88), (29.0, 0.88), (30.0, 0.88), (31.0, 0.88), (32.0, 0.88), (33.0, 0.88), (34.0, 0.88), (35.0, 0.89), (36.0, 0.89), (37.0, 0.89), (38.0, 0.89), (39.0, 0.9), (40.0, 0.9), (41.0, 0.9), (42.0, 0.9), (43.0, 0.91), (44.0, 0.91), (45.0, 0.91), (46.0, 0.92), (47.0, 0.92), (48.0, 0.92), (49.0, 0.93), (50.0, 0.93), (51.0, 0.94), (52.0, 0.94), (53.0, 0.94), (54.0, 0.94), (55.0, 0.95), (56.0, 0.95), (57.0, 0.95), (58.0, 0.96), (59.0, 0.96), (60.0, 0.96), (61.0, 0.96), (62.0, 0.97), (63.0, 0.97), (64.0, 0.97), (65.0, 0.97), (66.0, 0.98), (67.0, 0.98), (68.0, 0.98), (69.0, 0.98), (70.0, 0.99), (71.0, 0.99), (72.0, 0.99), (73.0, 1.00), (74.0, 1.00), (75.0, 1.00), (76.0, 1.00), (77.0, 1.00), (78.0, 1.00), (79.0, 1.00), (80.0, 1.00), (81.0, 1.00), (82.0, 1.01), (83.0, 1.01), (84.0, 1.00), (85.0, 1.01), (86.0, 1.01), (87.0, 1.01), (88.0, 1.01), (89.0, 1.02), (90.0, 1.01), (91.0, 1.01), (92.0, 1.01), (93.0, 1.01), (94.0, 1.02), (95.0, 1.02), (96.0, 1.02)

DEFN: Capital Equipment Cost Index for Manufacturing Industry

SOURCE: PW3210, Bureau of Labor Statistics, U.S. Department of Labor, CITIBASE: Citicorp Economic Data Base

AFFX: Cost_of_New_Capacity_Purchases(454) Combined_Price_Index(579)

690: Employment_Cost_Index = GRAPH(TIME)

DATA: (0.00, 0.78), (3.00, 0.79), (6.00, 0.8), (9.00, 0.81), (12.0, 0.81), (15.0, 0.82), (18.0, 0.83), (21.0, 0.83), (24.0, 0.83), (27.0, 0.84), (30.0, 0.85), (33.0, 0.85), (36.0, 0.86), (39.0, 0.87), (42.0, 0.88), (45.0, 0.88), (48.0, 0.89), (51.0, 0.9), (54.0, 0.91), (57.0, 0.91), (60.0, 0.92), (63.0, 0.94), (66.0, 0.95), (69.0, 0.96), (72.0, 0.96), (75.0, 0.97), (78.0, 0.98), (81.0, 0.99), (84.0, 1.00), (87.0, 1.01), (90.0, 1.02), (93.0, 1.02), (96.0, 1.03)

DEFN: Employment Cost Index for Durable Manufacturing

SOURCE: LZWIM, Bureau of Labor Statistics, U.S. Department of Labor, Taken from CITIBASE: Citicorp Economic Data Base

AFFX: Desired_Staff(8) Indicated_Overhead(348) Unit_Labor_Cost_per_Month(370) Combined_Price_Index(579)

691: IP_Index = GRAPH(Time)

DATA: (0.00, 0.28), (12.0, -0.09), (24.0, -0.02), (36.0, 0.15), (48.0, 0.11), (60.0, 0.06), (72.0, 0.01), (84.0, 0.07), (96.0, 0.1)

DEFN: Industrial Production Index For Electronic Components Manufacturers

SOURCE: IP376, Board of Governors of the Federal Reserve System, Business Conditions Section, Division of Research and Statistics, Taken from CITIBASE: Citicorp Economic Data Base

AFFX: Effect_of_Prd_Age_on_Growth(79)

14. Partial Model Tests

14.0 Overview

In the section we present the results of selected partial model tests. A partial model test, as described by Homer [1983], "... involves simulating the behavior of a functional component of the model...in response to empirical input data for comparison with empirical output data." The ability of the full model to replicate Analog's actual experience is discussed in Kofman *et. al.* [1994]. The partial tests presented here isolate individual sectors and test their ability to replicate Analog's experience when actual historical data is used as an input. Partial model tests play two important roles in establishing the validity of the full model. First, they significantly reduce the available degrees of freedom in any particular sector. Second, they help insure that the full model's ability to reproduce Analog's experience is not the result of compensating errors within the various sectors. For each test the mean absolute percent error between the simulated and actual data is calculated. The R^2 , defined as the squared correlation coefficient, is also presented. The root mean squared error between the two series is partitioned using the Theil Inequality statistics [Theil 1966]. Sterman [1984] discusses the uses of these statistics to diagnose specification and parametric errors in system dynamics models. Due to Analog's acquisition of its largest competitor in the fourth quarter of 1990, statistical comparisons are only calculated through the third quarter of 1990. Graphical results, however, are shown running through 1990.

14.1 The Product Development Sector

The product development sector takes research and development spending as its primary input. A partial test of this sector can be performed by substituting the model's endogenously generated series for Analog's historical experience. This is accomplished by setting the R&D switch, defined in equation #665, equal to one.

665: R_and_D_Switch = 1

The results of the test are shown in Figure 14.1 and the Theil Inequality statistics are given in Table 14.1. The measure of interest is cumulative product introductions since this, rather than quarterly or annual introductions, will be a key determinant of unit sales in the market sector. The focus on accumulated products results in steady upward trends. The squared correlation coefficient carries little meaning in the setting. However, the mean absolute percent error is quiet low, 3%, indicating a good fit between the model's output and Analog's historical performance. The error between the two series, noticeable in the final periods of the simulation, is due to the fact that the model overestimates the improvements that Analog made in reducing product development time.

Figure 14.1

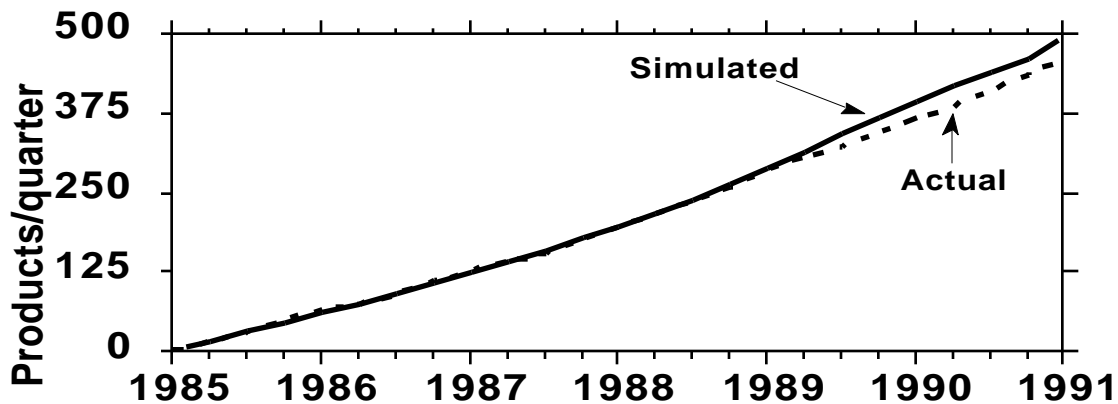

Table 14.1

MAPE	.03
Bias	.27
Variation	.36
Covariation	.18
Squared Correlation Coefficient	.99

14.2 The Market Sector

The market sector takes product introductions as its primary input. Because available data does not distinguish between breakthroughs and line extensions, for the purpose of performing the partial model test it is assumed that products are evenly split between the two categories. The partial test is performed by setting the product introduction switch, defined in equation #664, equal to one.

664: Prd_Intro_Switch = 1

The sector does an excellent job of replicating Analog's experience, see Figure 14.2 and Table 14.2. However, since only annual data were available for unit sales, the sample size is quite small, $n=6$. The mean absolute error is 4% and the square correlation coefficient is 97%. The model generated series also shows low bias. The substantial error in the final data point, fourth quarter 1990, is due to the fact that during that quarter Analog acquired its largest competitor, and, while the historical data includes this, the model does not include the acquisition.

Figure 14.2

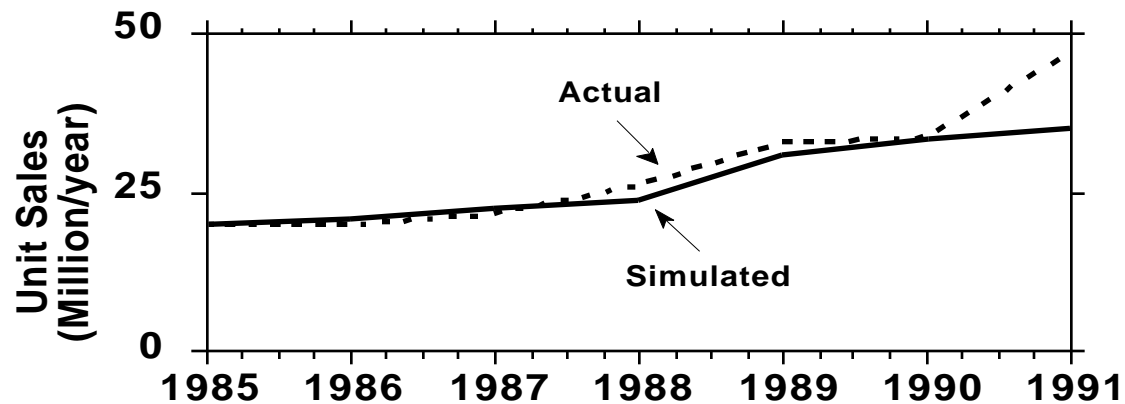

Table 14.2

MAPE	.04
Bias	.11
Variation	.28
Covariation	.61
R ²	.97

14.3 The Operations and Managerial Accounting Sectors

The operations and accounting sectors are tested jointly. The test input is Analog's actual annual unit sales. Three output series are examined: sales revenue, cost of goods sold, and operating income. The partial test is performed by setting the unit sales switch, defined in equation #667, equal to one.

667: Unit_Sales_Switch = 1

Since the input data are only available on an annual basis, sales are assumed to be evenly spread across each of the twelve months.

The sectors do an excellent job of replicating Analog's historical sales revenue, see Figure 14.3. The mean absolute percent error is only 3%, the bias component of the error is low, and the squared correlation coefficient is .97.

Figure 14.3.1

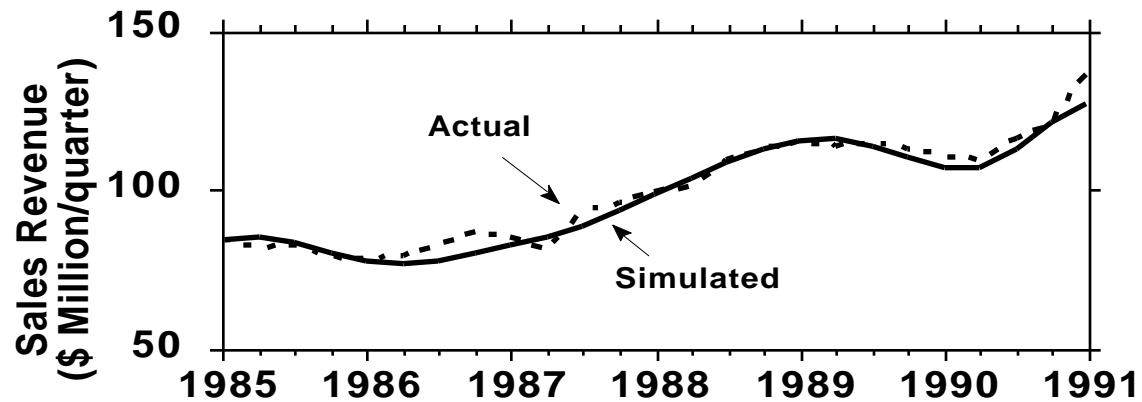

Table 14.3.1

MAPE	.03
Bias	.15
Variation	.00
Covariation	.85
R ²	.97

The sectors' ability to replicate cost of goods sold is also tested. As was the case with sales revenue, the fit is quite good. The mean absolute percent error is 4% and the squared correlation coefficient is .95.

Figure 14.3.2

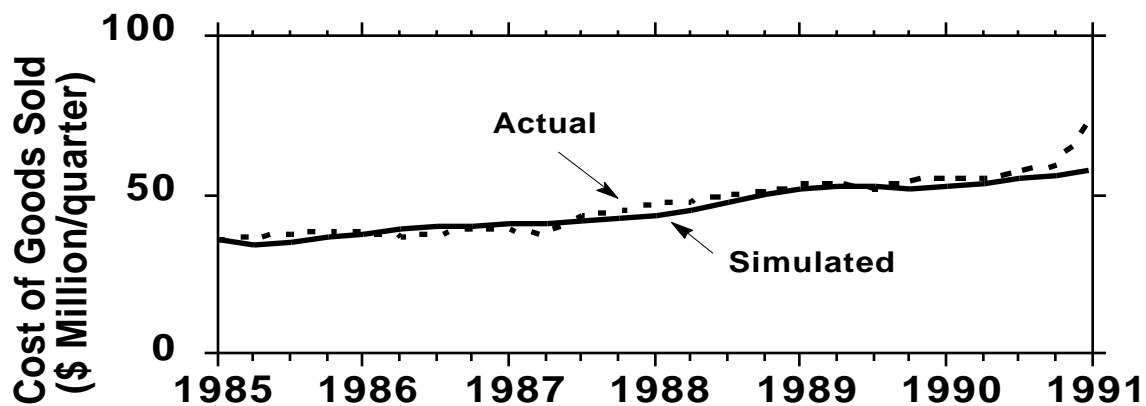
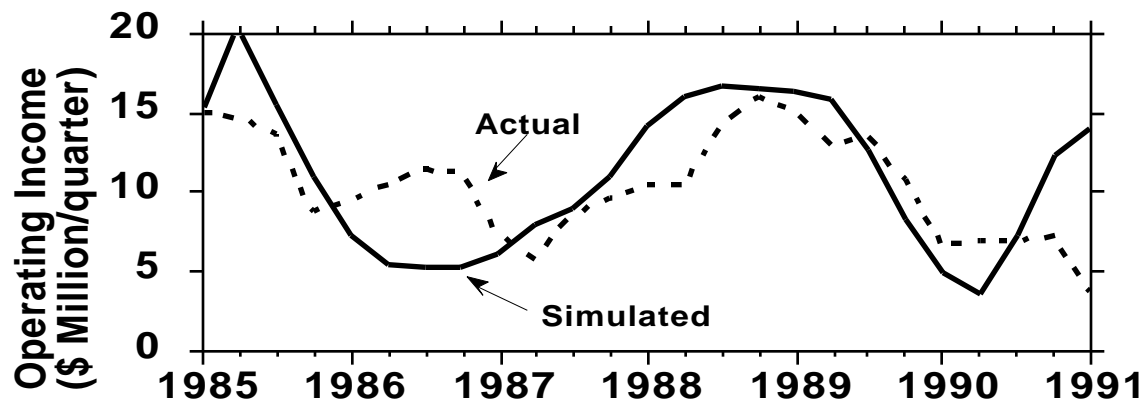

Table 14.3.2

MAPE	.04
Bias	.25
Variation	.15
Covariation	.60
R ²	.95

The final series compared for this test is operating income. In this case the mean absolute error is much higher, 27%, and the squared correlation coefficient much lower, .53. Operating income is the small difference of two large numbers; sales revenue, and the sum of cost of goods sold and operating expenses. As a result, small errors in any one of these numbers makes a proportionally larger difference in operating income. However, the model clearly captures the dominant behavior mode. Income declines from 1985 until the beginning of the TQM program in 1987. It then rises substantially until the beginning of 1989, and falls afterwards. The substantial increase in the final period of the simulated series, not matched by the real data, is again due to changes induced by the unmodeled acquisition.

Figure 14.3.3**Table 14.3.3**

MAPE	.27
Bias	.01
Variation	.28
Covariation	.71
R ²	.53

14.4 Research and Development Spending

The sector that determines spending on research and development takes sales revenue as its primary input. A partial test of this sector is performed by setting the sales revenue switch, defined in equation #666, equal to one.

666: Sales_Revenue_Switch = 1

This sector also does a good job of replicating Analog's historical experience. The mean absolute error is 6% and the squared correlation coefficient is .93. The bias component of the root mean squared error, however, is not trivial at .27.

Figure 14.4

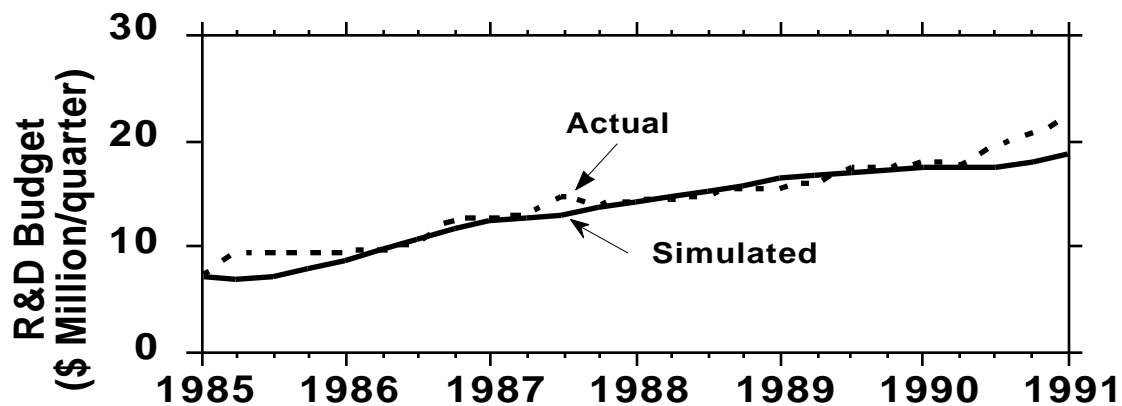

Table 14.4

MAPE	.06
Bias	.27
Variation	.01
Covariation	.71
R ²	.93

14.5 The Stock Market

The final partial test focuses on the stock market sector. This sector takes as its primary inputs operating income and sales revenue. The yield on the S&P 500, an exogenous input, is also used to calculate the discount rate potential investors uses to value Anlogs expected earnings. This test is performed by setting both the sales revenue switch, defined in equation #666, and the operating income switch, defined in equation #659, equal to one.

666: Sales_Revenue_Switch = 1

659: Operating_Income_Switch = 1

The sector also does a good job of representing the historical times series. The mean absolute percent error is 13% and the squared correlation coefficient is .81. Figure 14.5 also shows that the sector captures the dominant behavior mode. Both the simulated and actual stock price rise from 1985 until the October crash in 1987. The share price then declines steadily through 1991.

Figure 14.5

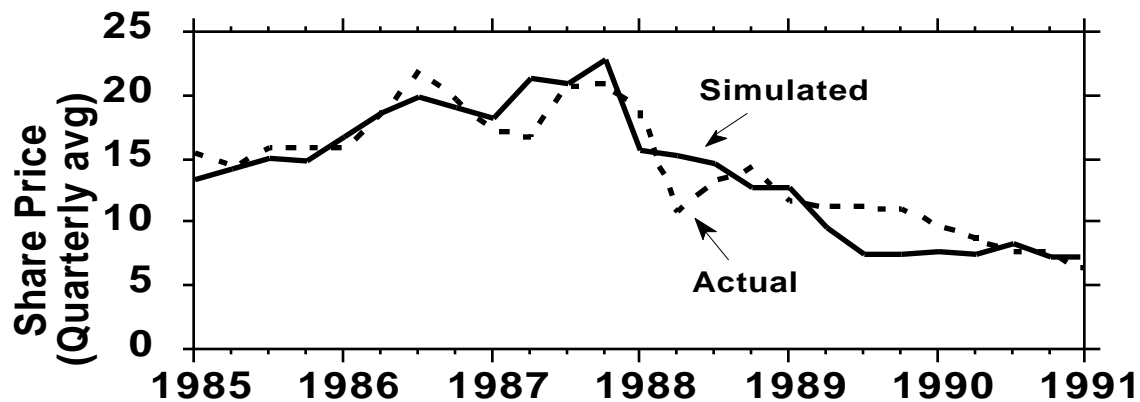

Table 14.5

MAPE	.13
Bias	.03
Variation	.09
Covariation	.88
R ²	.81

15. Instructions for Replicating Policy Simulations

15.0 Overview

The paper that accompanies this report [Kofman *et. al.* 1994] presents a number of policy runs along with the results of the base case simulation. The purpose of this section is to describe the instructions necessary to perform these policy tests, and identify the appropriate variables required to reproduce the figures and tables presented in the paper.

15.1 Base Case

The base case simulation can be performed with the equations in the exact form in which they have already been presented. The variables needed to re-create the policy comparison tables in the original paper, Tables 2,4,5, are given in table 15.1, while the variables names and reporting intervals needed to replicated figures 4 and 5 are provided in the table 15.2.

15.2 Analog Does Not Implement TQM

This first policy test analyzes what would have happened had Analog not implemented TQM. This policy can be simulated by multiplying the right hand side of equation #286, Top Management's Initial Move to TQM, by zero.

286: Top_Managements_Initial_Move_to_TQ = STEP(1,24)*0

This change causes TQM to never be implemented at Analog.

Table 15.1

Variables Name in Table	Variable Name in Model
Revenue	626:Sales_Revenue_Accumulator
Operating Income	617:Operating_Income_Accumulator
R&D Expenditure	623: R_and_D_Accumulator
Workforce	200: Labor_Force
Commitment to TQM in Manufacturing	270:TQM_Commitment_in_Manufacturing
Commitment to TQM in Product Development	273: TQM_Commitment_in_Product_Development
Breakthrough Products on the Market	72: Products_on_Market
Manufacturing Yield	219: Model_Yield
Outgoing Defects	216: Model_Defects
Manufacturing Cycle Time	213: Model_Cycle_Time
On-Time Delivery	95: Effective_OnTime_Delivery
Product Development Time	49: Reported_PD_Time
Stock Price	546: Stock_Price

15.3 Maintain a Policy of No-Layoffs

The second policy discussed is maintaining commitment to job security. This can be accomplished by multiplying the right-hand side of equation #203, the flow of lay-offs, by zero.

$$203: \text{Layoffs} = \text{MAX}((- \text{Labor_Discrepancy}) * \text{Effect_of_Financial_Stress_on_Layoffs} / \text{Time_to_Layoffs}, 0) * 0$$

This change implies that management can no longer reduce the stock of labor by lay-offs. Rather any desired reduction must come via attrition.

15.4 Maintain Morale While Downsizing

The third option discussed is a hypothetical policy in which morale could be maintained even with lay-offs. The policy is implemented by assuming that perceived job security is always 100%. The assumption of constant job security can be implemented in the model by multiplying the right-hand side of equation #284 by zero, and then adding one to that quantity.

$$284: \text{Perceived_Job_Security} = \text{MAX}(\text{SMTH1}(1 - \text{Financial_Stress}, 6), \text{Company_Commitment_to_Job_Security}) * 0 + 1$$

This modification insures that job security will remain at 100%. Figure 6 can be generated by plotting operating income, 617:Operating_Income_Accumulator, for the base case, the no lay-off policy, and this policy. Each series should again be on plotted quarterly basis.

Table 15.2

Figure	Variable One	Variable Two	Plot Interval
4A	626:Sales_Revenue_Accumulator	681: Actual_Sales_Revenue_by_Q	Quarterly
4B	617:Operating_Income_Accumulator	677:Actual_Operating_Income_by_Q	Quarterly
4C	539:Market_Value_to_Cash_Flow	639:Actual_Market_Value_to_Cash_Flow	Annually
4D	546: Stock_Price	669: Actual_Avg_Share_Price_by_Q	Quarterly
4E	213: Model_Cycle_Time	671: Actual_Cycle_Time	Quarterly
4F	219: Model_Yield	687:Actual_Yield	Monthly
4G	216: Model_Defects	672:Actual_Defects	Monthly
4H	95: Effective_OnTime_Delivery	678: Actual_OTD	Quarterly
5A	270:TQM_Commitment_ in_Manufacturing	273: TQM_Commitment_ in_Product_Development	Monthly
5B	284: Perceived_Job_Security		Monthly
5C	313: Total_Adequacy_of_ TQ_Support_Resources		Monthly
5D	302: Frac_TQ_Support_to_Manufacturing		Monthly
5E	49: Reported_PD_Time		Monthly

15.5 Maintaining Operating Margins

The final option discussed is a policy designed to maintain Analog's traditional operating margin. The policy is actually already available in the model, the user simply has to decided the start time. The results presented in Kofman *et. al.* [1994] are based upon the assumption that the new policy begins in the forty-second month of the simulation. The reader can replicate this by changing the right-hand side of equation #422, the pricing policy start time, to 42.

422: Policy_Start_Time = 42

This change results in an increase in Analog's target profit margin of 5%. The increase is phased in over a twelve month period. Figure 7 can be generated by plotting operating income, 617:Operating_Income_Accumulator, for the base case and this policy on a quarterly basis.

16. References

- Analog Devices (1985), *Analog Devices 1985 Annual Report*. Norwood, Ma. Analog Devices.
- Analog Devices (1986), *Analog Devices 1986 Annual Report*. Norwood, Ma. Analog Devices.
- Analog Devices (1987), *Analog Devices 1987 Annual Report*. Norwood, Ma. Analog Devices.
- Analog Devices (1988), *Analog Devices 1988 Annual Report*. Norwood, Ma. Analog Devices.
- Analog Devices (1989), *Analog Devices 1989 Annual Report*. Norwood, Ma. Analog Devices.
- Analog Devices (1990), *Analog Devices 1990 Annual Report*. Norwood, Ma. Analog Devices.
- Analog Devices (1991). *TQM at Analog*. Norwood, MA: Analog Devices.
- Analog Devices (1992), *Product Performance Database*., Internal Data Provided to Authors
- Barlas, Y. (1989). Multiple Tests for Validation of System Dynamics Type of Simulation Models. *European Journal of Operations Research*, 42(1), 59-87.
- Bass, Frank, "A New Product Growth Model for Consumer Durables", *Management Science*, Vol. 15, No.5, January 1969
- Bell D.E., R.L. Keeney, and J.D.C. Little, (1975), "A Market Share Theorem", *Journal of Marketing Research*, 12 May:136-141.
- Bluestone, B. and I. Bluestone (1992). Workers (and Managers) of the World Unite. *Technology Review*. November/December, 30-40.
- Cyert, R. and March, J. (1963) *A Behavioral Theory of the Firm*. Englewood Cliffs, NJ: Prentice Hall.
- Forrester, J. W. (1961). *Industrial Dynamics*. Cambridge MA: Productivity Press.
- Forrester, J. W. (1969). *Urban Dynamics*. Cambridge MA: Productivity Press.
- Forrester, J. W., & Senge, P. M. (1980). Tests for Building Confidence in System Dynamics Models. In Legasto, A. et al. (Eds.), *System Dynamics* (209-228). New York: North-Holland.
- Hall, R. I. (1976). A System Pathology of an Organization: The Rise and Fall of the Old Saturday Evening Post. *Administrative Science Quarterly*, 21(2), 185-211.
- Hall, R. I. (1983). A Corporate System Model of a Sports Club: Using Simulation as an Aid to Policy making in A Crisis, *Management Science*. 29(1), 52-64.
- Hall, R. I. (1984) The Natural Logic of Management Policy Making: Its Implications for the Survival of an Organization. *Management Science*. 30, 905-927.
- Homer, J. B. (1983). Partial-Model Testing As A Validation Tool for System Dynamics. In *Proc. of the 1983 International System Dynamics Conference*. Chestnut Hill, MA. 920-932

Homer, J. B. (1987). A Diffusion Model with Application to Evolving Medical Technologies. *Technological Forecasting and Social Change*, 31(3), 197-218.

Homer, Jack B.(1983) "Partial-model testing as a validation tool for system dynamics", in *Proceedings of 1983 International System Dynamics Conference*, Boston, MA, 919-931.

Hongren, C., and G. Foster, (1992) *Cost Accounting: A Managerial Emphasis*, New Jersey, Prentice Hall.

Kalish, S., and G. Lilien (1986), "Application of Innovation Diffusion Models in Marketing", in *Innovation Diffusion Models of New Product Acceptance*, V. Mahajan and Y. Wind Eds., Cambridge, Ma., Ballinger Publishing Company.

Kaplan, R. (1990a) Analog Devices: The Half-Life System, Case 9-191-061, Harvard Business School.

Kaplan, R. (1990b) Analog Devices: The Half-Life System, Teaching Note 5-191-103, Harvard Business School.

Kaplan, R. and D. Norton (1992) The Balanced Scorecard – Measures that Drive Performance, *Harvard Business Review*, Jan-Feb. 1992, 71-79.

Kofman, F. N. Repenning, and J. Sterman (1994), Unanticipated Side Effects of Successful Quality Program: Exploring a Paradox of Organizational Improvement, Working Paper #3667-94-MSA, Sloan School of Management, Cambridge, MA, 02412. (Revised Version D-4309-1)

Kress, David (1992), Personal Interview, March.

Lyneis, J. M. (1980) *Corporate Planning and Policy Design*. Portland, OR: Productivity Press.

Mass, N.J., (1975) *Economic Cycles: An Analysis of Underlying Causes* Cambridge, Ma., Wright-Allen Press.

Morecroft, J. (1985) Rationality in the Analysis of Behavioral Simulation Models. *Management Science* 31 (7): 900-916.

Paich, M. and Sterman, J. (1993) Boom, Bust, and Failures to Learn in Experimental Markets. *Management Science*, 39(12), 1439-1458.

Palmer, L., (1993) Personal Interview, October 7th.

Peterson, J. and L. T. How (1993). A system analysis of total quality management implementation false starts. Unpublished MS thesis, Sloan School of Management, MIT.

Repenning, N. (1994) Modeling the Failure of Productivity Improvement Programs, Working Paper, Sloan School of Management., M.I.T., Cambridge 02142.

Richardson, G. P. (1991). *Feedback Thought in Social Science and Systems Theory*. Philadelphia: University of Pennsylvania Press.

Richmond, B. (1994) *iThink Software Users Guide*, Hanover, NH, High Performance Systems.

- Roberts, E. B. (ed.). (1978) *Managerial Applications of System Dynamics*. Cambridge MA: Productivity Press.
- Schaffer, R. and H. Thomson (1992) Successful Change Programs Begin with Results, *Harvard Business Review*, Jan/Feb. 80-89.
- Schneiderman, A. (1988) Setting Quality Goals, *Quality Progress*. April, 55-57.
- Schneiderman, A. (1991) A Model for TQM Problem Solving, Unpublished presentation.
- Schneiderman, A. (1992a), Personal Interview, March.
- Schneiderman, A. (1992b), Personal Interview, April.
- Shiba, S, D. Walden, A. Graham (1993) *A New American TQM. Four Practical Revolutions in Management*. Portland, OR: Productivity Press.
- Simon, H. (1976) *Administrative Behavior*,
- Stata, R. (1989) Organizational Learning — The Key to Management Innovation, *Sloan Management Review*, 30(3) Spring, 63-74.
- Stata, R. (1993) Personal Interview, 16 February
- Sterman, J. D. (1987). Expectation Formation in Behavioral Simulation Models. *Behavioral Science*, 32, 190-211.
- Sterman, J. D. (1984). Appropriate Summary Statistics for Evaluating the Historical Fit of System Dynamics Models. *Dynamica*, 10(2), 51-66.
- Sterman, J. D. (1988). Modeling the Formation of Expectations: The History of Energy Demand Forecasts. *International Journal of Forecasting*, 4, 243-259.
- Sterman, J. D. (1989a) Misperceptions of Feedback in Dynamic Decision Making. *Organizational Behavior and Human Decision Processes* 43 (3): 301-335.
- Sterman, J. D. (1989b) Modeling Managerial Behavior: Misperceptions of Feedback in a Dynamic Decision Making Experiment. *Management Science* 35 (3): 321-339.
- Sutter, G. (1994), Personal Interview, 10 November.
- Theil, H. (1966) *Applied Econometric Forecasting*. Amsterdam: North Holland.
- Value Line (1991a). Investment Survey: Supplementary Reports. 30 August, 1740.
- Value Line (1991b) Investment Survey: Analog Devices, 1 November.
- Value Line (1992) Investment Survey: Analog Devices, 1 May.